

Altivar Soft Starter ATS490

Soft Starter for Asynchronous Motors

User Manual

PKR52680.03
01/2026



Legal Information

The information provided in this document contains general descriptions, technical characteristics and/or recommendations related to products/solutions.

This document is not intended as a substitute for a detailed study or operational and site-specific development or schematic plan. It is not to be used for determining suitability or reliability of the products/solutions for specific user applications. It is the duty of any such user to perform or have any professional expert of its choice (integrator, specifier or the like) perform the appropriate and comprehensive risk analysis, evaluation and testing of the products/solutions with respect to the relevant specific application or use thereof.

The Schneider Electric brand and any trademarks of Schneider Electric SE and its subsidiaries referred to in this document are the property of Schneider Electric SE or its subsidiaries. All other brands may be trademarks of their respective owner.

This document and its content are protected under applicable copyright laws and provided for informative use only. No part of this document may be reproduced or transmitted in any form or by any means (electronic, mechanical, photocopying, recording, or otherwise), for any purpose, without the prior written permission of Schneider Electric.

Schneider Electric does not grant any right or license for commercial use of the document or its content, except for a non-exclusive and personal license to consult it on an "as is" basis.

Schneider Electric reserves the right to make changes or updates with respect to or in the content of this document or the format thereof, at any time without notice.

To the extent permitted by applicable law, no responsibility or liability is assumed by Schneider Electric and its subsidiaries for any errors or omissions in the informational content of this document, as well as any non-intended use or misuse of the content thereof.

Table of Contents

Safety Information.....	7
About The Document	9
Technical Data for Designers	18
Major Characteristics	20
Connection In line and Inside Delta	22
ATS490 and Motor Combination	23
Dimensions	27
Mounting Position	31
Enclosure Thermal Design	32
IP20 kits and Protective Covers	35
Application Diagrams	37
Type of coordination	44
Control Block Wiring Diagram	45
Control Terminal Characteristics	46
RUN and STOP Management	49
Relay Contacts Wiring	52
Software and Tools	55
Cybersecurity Generalities	56
Inspect, Store and Handle the Product.....	68
Inspecting the Product	69
Storage and Shipping	70
Weight And Lifting Lugs Availability	72
Unpacking and Hoisting on Pallet.....	73
Installation.....	75
Electronic product data sheet	76
Mounting a graphic display terminal VW3A1111 on the door of the enclosure.....	77
Inserting the Fieldbus Modules	78
Wiring.....	79
Wiring the Power Part for ATS490D17Y...ATS490C11Y	82
Wiring the Power Part for ATS490C14Y...ATS490M12Y	84
Wiring the Control Terminals	87
Checking Installation.....	91
Product HMI	93
Front Product LEDs	94
Display Terminal	95
Configure the display terminal	97
Commissioning.....	107
First Power-Up	108
Define Parameter Visibility	113
Define Favorite Parameters List.....	117
Main Menu Presentation	118
Simply Start	119
Monitoring Settings.....	128
Other Settings	149
Inside the Delta of the Motor.....	156
Small Motor Test.....	160

Torque / Voltage Control	162
Start and Stop	164
Motor Preheating	168
Smoke Extraction	174
Voltage Boost	177
Borehole Pump	178
Reverse by External Contactor	179
Motor Jog	182
Anti-Jam	184
Second Set of Motor Parameters	190
Functions Compatibility Table	195
Command Channel	197
Input/Output Assignment	202
Configuration Files Management	212
Soft Starter Configuration files	213
Save & Restore a device configuration	214
Save & Restore a device image	215
Reset to Factory Settings	216
Proceed with a Manufacturer Factory settings	216
Proceed with a User-Defined Factory settings	217
Product Restart	218
Soft starter firmware update	219
Option Modules Firmware update	222
Cybersecurity operating	223
Overview	224
Login	225
Logout	226
Account Management	227
Password	229
PIN Code	231
Admin Credentials Recovery	232
Upgrades Management	233
Save & Restore a Security Policy	234
Port Hardening	235
Security Functionality Verification	236
Clear Device / Secure Decommissioning	239
Communication	240
Modbus VP12S port configuration	241
Modbus Network Diagnostics	244
Ethernet Embedded Configuration	245
Ethernet Embedded Diagnostic	247
PROFINET module Basic Settings	248
CANopen fieldbus	252
PROFIBUS fieldbus	254
Monitor the displayed values	255
Motor Parameters	256
Monitor current measurements	257
Monitor voltage measurements	258
Monitor power measurements	259
Monitor other measurements	260

Monitor thermal measurements	262
Counter Management	263
Other States	264
Input & Output Map.....	265
Energy parameters	267
Diagnostics and Troubleshooting	268
LED status	269
Diagnostic Data	271
Error History	274
Warnings	276
Fan diagnostic.....	277
Fan status	277
Fan diagnostics test	278
Fan Counter Reset.....	278
Error and Warning Handling	279
Security Event Logging	283
Troubleshooting	285
Warning messages and error codes	287
Maintenance	315
Scheduled Servicing.....	316
Define a service message	321
Real Time Clock (RTC)	322
Decommissioning	323
Additional Support	324
Annex.....	326
How to interpret and react to a NST state.....	327
How to interpret and react to a TBS state.....	328
How to determine which units are applicable for your soft starter?	329
Difference between Normal and Heavy duty	330
Soft Starter State	331
Perform a demonstration with the device	332
HMI Tree Navigation	337
Glossary	363

Safety Information

Important Information

Read these instructions carefully, and look at the equipment to become familiar with the device before trying to install, operate, service, or maintain it. The following special messages may appear throughout this documentation or on the equipment to warn of potential hazards or to call attention to information that clarifies or simplifies a procedure.



The addition of this symbol to a “Danger” or “Warning” safety label indicates that an electrical hazard exists which will result in personal injury if the instructions are not followed.



This is the safety alert symbol. It is used to alert you to potential personal injury hazards. Obey all safety messages that follow this symbol to avoid possible injury or death.

DANGER

DANGER indicates a hazardous situation which, if not avoided, **will result in** death or serious injury.

WARNING

WARNING indicates a hazardous situation which, if not avoided, **could result in** death or serious injury.

CAUTION

CAUTION indicates a hazardous situation which, if not avoided, **could result in** minor or moderate injury.

NOTICE

NOTICE is used to address practices not related to physical injury.

Please Note

Electrical equipment should be installed, operated, serviced, and maintained only by qualified personnel. No responsibility is assumed by Schneider Electric for any consequences arising out of the use of this material.

A qualified person is one who has skills and knowledge related to the construction and operation of electrical equipment and its installation, and has received safety training to recognize and avoid the hazards involved.

Qualification of Personnel

Only appropriately trained persons who are familiar with and understand the contents of this manual and all other pertinent product documentation are authorized to work on and with this product. In addition, these persons must have received safety training to recognize and avoid hazards involved. These persons must have sufficient technical training, knowledge and experience and be able to foresee and detect potential hazards that may be caused by using the product, by changing the settings and by the mechanical, electrical and electronic equipment of the entire system in which the product is used. All persons working on and with the product must be fully familiar with all applicable standards, directives, and accident prevention regulations when performing such work.

Intended Use

This product is intended for industrial use according to this manual.

The product may only be used in compliance with all applicable safety standard and local regulations and directives, the specified requirements and the technical data. The product must be installed outside the hazardous ATEX zone. Prior to using the product, you must perform a risk assessment in view of the planned application. Based on the results, the appropriate safety measures must be implemented. Since the product is used as a component in an entire system, you must ensure the safety of persons by means of the design of this entire system (for example, machine design). Any use other than the use explicitly permitted is prohibited and can result in hazards.

About The Document

Document scope

The purpose of this document is:

- to give mechanical and electrical information related to the Altivar Soft Starter ATS490.
- to show how to install, wire and program this soft starter.

Validity note

Original instructions and information given in the present document have been written in English (before optional translation).

NOTE: The products listed in the document are not all available at the time of publication of this document online. The data, illustrations and product specifications listed in the guide will be completed and updated as the product availabilities evolve. Updates to the guide will be available for download once products are released onto the market.

This documentation is valid only for ATS490.

The characteristics that are presented in this manual should be the same as those characteristics that appear online. In line with our policy of constant improvement, we may revise content over time to improve clarity and accuracy. If you see a difference between the manual and online information, use the online information as your reference.

Product related information

Read and understand these instructions before performing any procedure with this soft starter.

DANGER

HAZARD OF ELECTRIC SHOCK, EXPLOSION, OR ARC FLASH

- Only appropriately trained persons who are familiar with and fully understand the contents of the present manual and all other pertinent product documentation and who have received all necessary training to recognize and avoid hazards involved are authorized to work on and with this equipment.
- Installation, adjustment, repair and maintenance must be performed by qualified personnel.
- Verify compliance with all local and national electrical code requirements as well as all other applicable regulations with respect to grounding of all equipment.
- Only use properly rated, electrically insulated tools and measuring equipment.
- Do not touch unshielded components or terminals with voltage present.
- Prior to performing any type of work on the equipment, block the motor shaft to prevent rotation.
- Insulate both ends of unused conductors of the motor cable.

Failure to follow these instructions will result in death or serious injury.

 DANGER

HAZARD OF ELECTRIC SHOCK, EXPLOSION, OR ARC FLASH

Before performing work on the equipment:

- Use all required personal protective equipment (PPE).
- Disconnect all power, including external control power that may be present. Take into account that the circuit breaker or main switch does not de-energize all circuits.
- Place a "Do Not Turn On" label on all power switches related to the equipment.
- Lock all power switches in the open position.
- Verify the absence of voltage using a properly rated voltage sensing device.

Before applying voltage to the equipment:

- Verify that the work has been completed and that the entire installation cannot cause hazards.
- If the mains input terminals and the motor output terminals have been grounded and short-circuited, remove the ground and the short circuits on the mains input terminals and the motor output terminals.
- Verify proper grounding of all equipment.
- Verify that all protective equipment such as covers, doors, grids is installed and/or closed.

Failure to follow these instructions will result in death or serious injury.

 DANGER

HAZARD OF ELECTRIC SHOCK, EXPLOSION, OR ARC FLASH

- Never operate energized switch with door open.
- Turn off switch before removing or installing fuses or making load side connections.
- Do not use renewable link fuses in fused switches.

Failure to follow these instructions will result in death or serious injury.

Damaged products or accessories may cause electric shock or unanticipated equipment operation.

 DANGER

ELECTRIC SHOCK OR UNANTICIPATED EQUIPMENT OPERATION

Do not use damaged products or accessories.

Failure to follow these instructions will result in death or serious injury.

Contact your local Schneider Electric sales office if you detect any damage whatsoever.

This equipment has been designed to operate outside of any hazardous location. Only install this equipment in zones known to be free of a hazardous atmosphere.

 DANGER

POTENTIAL FOR EXPLOSION

Install and use this equipment in non-hazardous locations only.

Failure to follow these instructions will result in death or serious injury.

Your application consists of a whole range of different interrelated mechanical, electrical, and electronic components, the device being just one part of the application. The device by itself is neither intended to nor capable of providing the entire functionality to meet all safety-related requirements that apply to your application. Depending on the application and the corresponding risk assessment to be conducted by you, a whole variety of additional equipment is required such as, but not limited to, external monitoring devices, guards, etc.

As a designer/manufacturer of machines, you must be familiar with and observe all standards that apply to your machine. You must conduct a risk assessment and determine the appropriate Performance Level (PL) and/or Safety Integrity Level (SIL) and design and build your machine in compliance with all applicable standards. In doing so, you must consider the interrelation of all components of the machine. In addition, you must provide instructions for use that enable the user of your machine to perform any type of work on and with the machine such as operation and maintenance in a safe manner.

The present document assumes that you are fully aware of all normative standards and requirements that apply to your application. Since the device cannot provide all safety-related functionality for your entire application, you must ensure that the required Performance Level and/or Safety Integrity Level is reached by installing all necessary additional equipment.

▲ WARNING

INSUFFICIENT PERFORMANCE LEVEL/SAFETY INTEGRITY LEVEL AND/OR UNINTENDED EQUIPMENT OPERATION

- Conduct a risk assessment according to EN ISO 12100 and all other standards that apply to your application.
- Use redundant components and/or control paths for all critical control functions identified in your risk assessment.
- Verify that the service life of all individual components used in your application is sufficient for the intended service life of your overall application.
- Perform extensive commissioning tests for all potential error situations to verify the effectiveness of the safety-related functions and monitoring functions implemented, for example, but not limited to, speed monitoring by means of encoders, short circuit monitoring for all connected equipment, correct operation of brakes and guards.
- Perform extensive commissioning tests for all potential error situations to verify that the load can be brought to a safe stop under all conditions.

Failure to follow these instructions can result in death, serious injury, or equipment damage.

Product may perform unexpected movements because of incorrect wiring, incorrect settings, incorrect data or other errors.

▲ WARNING

UNANTICIPATED EQUIPMENT OPERATION

- Carefully install the wiring in accordance with the EMC requirements.
- Do not operate the product with unknown or unsuitable settings or data.
- Perform a comprehensive commissioning test.

Failure to follow these instructions can result in death, serious injury, or equipment damage.

⚠ WARNING
LOSS OF CONTROL <ul style="list-style-type: none">• The designer of any control scheme must consider the potential failure modes of control paths and, for critical control functions, provide a means to achieve a safe state during and after a path failure. Examples of critical control functions are emergency stop, overtravel stop, power outage and restart.• Separate or redundant control paths must be provided for critical control functions.• System control paths may include communication links. Consideration must be given to the implications of unanticipated transmission delays or failures of the link.• Observe all accident prevention regulations and local safety guidelines (1).• Each implementation of the product must be individually and thoroughly tested for proper operation before being placed into service. <p>Failure to follow these instructions can result in death, serious injury, or equipment damage.</p>

(1) For USA: Additional information, refer to NEMA ICS 1.1 (latest edition), Safety Guidelines for the Application, Installation and Maintenance of Solid State Control.

Machines, controllers, and related equipment are usually integrated into networks. Unauthorized persons and malware may gain access to the machine as well as to other devices on the network/fieldbus of the machine and connected networks via insufficiently secure access to software and networks.

⚠ WARNING
UNAUTHORIZED ACCESS TO THE MACHINE VIA SOFTWARE AND NETWORKS <ul style="list-style-type: none">• In your hazard and risk analysis, consider all hazards that result from access to and operation on the network/fieldbus and develop an appropriate cybersecurity concept.• Verify that the hardware infrastructure and the software infrastructure into which the machine is integrated as well as all organizational measures and rules covering access to this infrastructure consider the results of the hazard and risk analysis and are implemented according to best practices and standards covering IT security and cybersecurity (such as: ISO/IEC 27000 series, Common Criteria for Information Technology Security Evaluation, ISO/IEC 15408, IEC 62351, ISA/IEC 62443, NIST Cybersecurity Framework, Information Security Forum - Standard of Good Practice for Information Security, SE recommended Cybersecurity Best Practices*).• Verify the effectiveness of your IT security and cybersecurity systems using appropriate, proven methods. <p>Failure to follow these instructions can result in death, serious injury, or equipment damage.</p>

(*) : SE Recommended Cybersecurity Best Practices can be downloaded on SE.com.

⚠ WARNING
LOSS OF CONTROL <p>Perform a comprehensive commissioning test to verify that communication monitoring properly detects communication interruptions.</p> <p>Failure to follow these instructions can result in death, serious injury, or equipment damage.</p>

This product meets the EMC requirements according to the standard IEC 60947-4-2. This device has been designed for environment A. Use of this product in a domestic environment (B environment) may cause unwanted radio interference.

WARNING

RADIO INTERFERENCE

- In a domestic environment (B environment), this product may cause radio interference in which case supplementary mitigation measures may be required.

Failure to follow these instructions can result in death, serious injury, or equipment damage.

NOTICE

DESTRUCTION DUE TO INCORRECT MAINS VOLTAGE

Before switching on and configuring the product, verify that it is approved for the mains voltage.

Failure to follow these instructions can result in equipment damage.

General Cybersecurity Information

In recent years, the growing number of networked machines and production plants has seen a corresponding increase in the potential for cyber threats, such as unauthorized access, data breaches, and operational disruptions. You must, therefore, consider all possible cybersecurity measures to help protect assets and systems against such threats.

To help keep your Schneider Electric products secure and protected, it is in your best interest to implement the cybersecurity best practices as described in the [Cybersecurity Best Practices](#) document.

Schneider Electric provides additional information and assistance:

- [Subscribe to the Schneider Electric security newsletter.](#)
- [Visit the Cybersecurity Support Portal web page to:](#)
 - [Find Security Notifications.](#)
 - [Report vulnerabilities and incidents.](#)
- [Visit the Schneider Electric Cybersecurity and Data Protection Posture web page to:](#)
 - [Access the cybersecurity posture.](#)
 - [Learn more about cybersecurity in the cybersecurity academy.](#)
 - [Explore the cybersecurity services from Schneider Electric.](#)

Environmental Data

The Environmental Data Program is a framework for how we measure, categorize, and compare the environmental attributes and footprint of our products.

Using a rigorous, fact-based methodology, the program provides environmental data from across the product lifecycle.

Five data categories across the product lifecycle

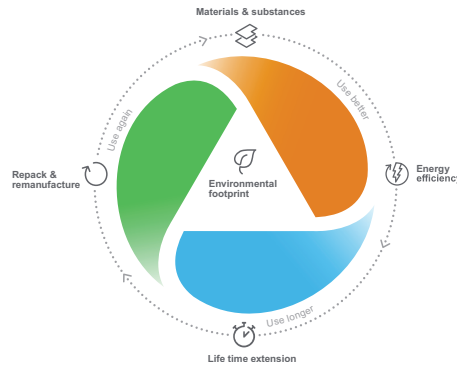

Use Better: How sustainable a product is, including environmental footprint, materials and substances, packaging, and energy efficiency.

Use Longer: How a product's life time can be effectively extended in terms of reparability and updatability.

Use Again: How a product can be reused, from dismantling and remanufacturing to recyclability and manufacturer take back.

With this transparent, verified data, customers and partners are empowered to make conscious environmental choices and accurately evaluate and report on sustainability performance.

All our hardware offers have an associated environmental data available on se.com product pages.

Refer to Environmental Data Program for more information.

Related Documents

Use your tablet or your PC to quickly access detailed and comprehensive information on all our products on www.se.com The Internet site provides the information you need for products and solutions:

- The whole catalog for detailed characteristics and selection guides
- The CAD files to help design your installation, available in over 20 different file formats
- All software and firmware to maintain your installation up to date
- A large quantity of White Papers, Environment documents, Application solutions, Specifications... to gain a better understanding of our electrical systems and equipment or automation
- And finally all the User Guides related to your soft starter, listed below:

Catalog

Title of documentation	Reference number
Catalog: Altivar Soft Starter ATS490	DIA2ED2240603EN (English) DIA2ED2240603FR (French)

Documentations

Title of documentation	Reference number
ATS490 Getting Started	PKR63410 (English), PKR63411 (French) PKR63412 (Spanish), PKR63413 (Italian) PKR63414 (German), PKR63415 (Chinese) PKR63416 (Portuguese), PKR63417 (Turkish)
ATS490 Getting Started Manual Annex for UL	PKR63418 (English)
ATS490 User Manual	PKR52680 (English), PKR52681 (French) PKR52682 (Spanish), PKR52683 (Italian) PKR52684 (German), PKR52685 (Chinese) PKR52686 (Portuguese), PKR52687 (Turkish)
ATS490 Embedded Safety Function Manual	PKR63419 (English)
ATS490 ATEX Manual	BQT74920 (English)
ATS490 Embedded Modbus RTU Manual	PKR63421 (English)
ATS490 EtherNet Manual	PKR63423 (English)
ATS490 PROFIBUS DP Manual (VW3A3607)	PKR63425 (English)
ATS490 CANopen Manual (VW3A3608, VW3A3618, VW3A3628)	PKR63426 (English)
ATS490 PROFINET Manual (VW3A3647)	PKR63424 (English)
ATS490 Communication Parameter Addresses	PKR63420 (English)
Recommended Cybersecurity Best Practices	CS-Best-Practices-2019-340 (English)

You can download there technical publications and other technical information from our website at www.se.com/en/download.

Videos

Title of documentation	Reference number
Video: Getting Started with ATS490	FAQ000263202 (English)

Software

Title of documentation	Reference number
SoMove: FDT	SoMove FDT (English, French, German, Spanish, Italian, Chinese)
ATS490: DTM	ATS490 DTM Library EN (English – to be installed first) ATS490 DTM Lang FR (French) ATS490 DTM Lang SP (Spanish) ATS490 DTM Lang IT (Italian) ATS490 DTM Lang DE (German) ATS490 DTM Lang CN (Chinese)

Terminology

The technical terms, terminology, and the corresponding descriptions in this manual normally use the terms or definitions in the relevant standards.

In the area of soft starters this includes, but is not limited to, terms such as **error**, **error message**, **failure**, **fault**, **fault reset**, **protection**, **safe state**, **safety function**, **warning**, **warning message**, and so on.



Among others, these standards include:

- ISO 13849-1 & 2 Safety of machinery - safety related parts of control systems
- IEC 61158 series: Industrial communication networks - Fieldbus specifications
- IEC 61784 series: Industrial communication networks - Profiles
- IEC 60204-1: Safety of machinery - Electrical equipment of machines – Part 1: General requirements
- IEC 60947–1 Low-Voltage Switchgear and Control Gear – General rules
- IEC 60947–4-2 Semiconductor Motor controllers, Starters and Soft Starters
- IEC 62443: Security for industrial automation and control systems

In addition, the term **zone of operation** is used in conjunction with the description of specific hazards, and is defined as it is for a **hazard zone** or **danger zone** in the EC Machinery Directive (2006/42/EC) and in ISO 12100.

Also see the glossary at the end of this manual.

Structure of the Parameter Table

Pictogram	Description
	Power cycle must be performed after setting this parameter.
	Read only parameter, mainly used for monitoring.
	Expert mode required to access this parameter.

Contact us

Select your country on www.se.com/contact.

Schneider Electric Industries SAS

Head Office

35, rue Joseph Monier

92500 Rueil-Malmaison

France

Technical Data for Designers

What's in This Part

Major Characteristics	20
Connection In line and Inside Delta	22
ATS490 and Motor Combination	23
Dimensions	27
Mounting Position	31
Enclosure Thermal Design	32
IP20 kits and Protective Covers	35
Application Diagrams	37
Type of coordination	44
Control Block Wiring Diagram	45
Control Terminal Characteristics	46
RUN and STOP Management	49
Relay Contacts Wiring	52
Software and Tools	55
Cybersecurity Generalities	56

Software Enhancements

Overview

NOTE: Make sure that the latest version of the software and of the user manual are used.

The Altivar Soft Starter ATS490 will benefit from future software enhancements. Those enhancements will be listed below.

This documentation relates to the version V1.2.

V1.1 Release Note

Initial release

V1.2 Release Note

- Support of PROFINET option module.
- In the **[Complete settings]** menu, **[Reverse by contactor]** menu is reworked.

Major Characteristics

Electrical Data

Utilization Category	AC-53a : 4–13 : 50–10 (ATS490D17Y...C17Y) 50–6 (ATS490C21Y...M12Y)
Ue Power supply voltage	208...690 Vac
	Tolerance: -15...+10%
Power supply frequency	50...60 Hz
	Tolerance: -20...+20%
Ie Rated operational current	17...1200 A
Us control supply voltage	110...230 Vac
	Tolerance: -15...+10%
	50/60 Hz
Current limiting	500% Ie (700% rated motor current)

Application Data

Application	Normal duty and Heavy Duty
Torque Control	Yes
Voltage Control	Yes
Controlled stop	Yes
Braking	Yes
Connection Inside the Delta	Yes
Bypass	Embedded Bybass

Environment Data

NOTE: The soft starter is designed to be used in a controlled indoor environment.

Degree of protection	IEC 60529	<ul style="list-style-type: none"> • IP20 for ATS490D17Y to C11Y • IP00 for ATS490C14Y to M12Y 	
Vibration resistance	IEC 60068-2-6	<ul style="list-style-type: none"> • 1.5 mm peak at 2 to 13 Hz • 10 m/s² (1g) at 13 to 200 Hz 	
Shock resistance	IEC 60068-2-27	150 m/s ² (15 g) during 11 ms	
Maximum ambient pollution degree	IEC 60664-1	Level 3	
Maximum relative humidity	IEC 60068-2-3	5...95% without condensation or dripping water	
Ambient temperature around the unit	-	-25...40 °C (-13...104 °F)	No derating
		up to 60 °C (up to 140 °F)	Derate current by 1% each °C (1.8 °F)
Maximum operating altitude	0...2000m (0...6600ft)	No derating	
	2000...4800m (6600...15700ft)	Derate current by 1% each additional 100m (330ft)	
Operating position	Vertical at ± 10°		

Mains Supply in Function of the System Earthing Arrangement According to the Altitude

Mains voltage	System earthing arrangement	Supply source overvoltage category required according to altitude (1)	
		Up to 2000 m (6600 ft)	From 2000 m to 4800 m (6600 ft to 15700 ft)
208...480 Vac	TT or TN	OVC III	OVC III
	IT or Corner-Grounded	OVC III	OVC III
480...600 Vac	TT or TN	OVC III	OVC III
	IT or Corner-Grounded	OVC III	OVC III
600...690 Vac	TT or TN	OVC III	OVC III
	IT	OVC II	-

(1) according to IEC60947-1

The supply source overvoltage category could be reduced by using an appropriate system such as an insulation transformer.

The altitude itself impacts the cooling of the soft starter:

- 0...2000 m (0...6600 ft) without derating of the rated operational current (I_e).
- 2000...4800 m (6600...15700 ft) with derating of the rated operational current (I_e) of 1% per 100 m (330 ft).

Connection In line and Inside Delta

Connection In-Line

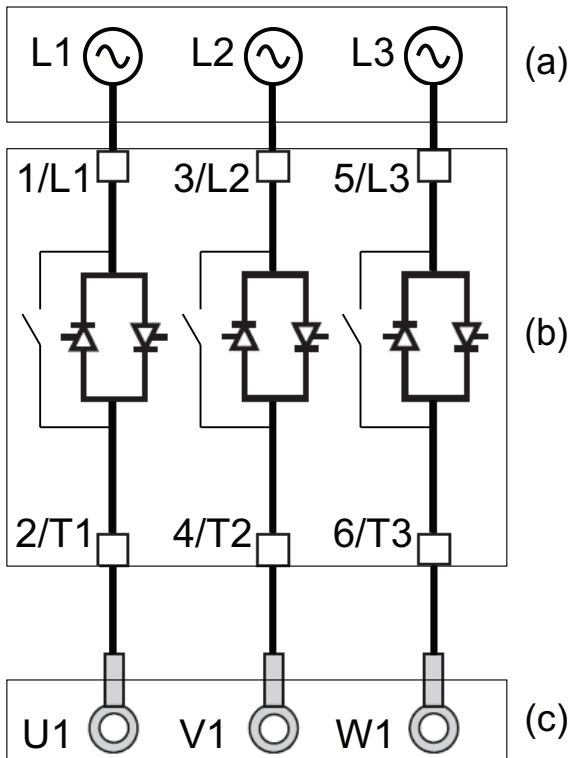

The soft starter can be connected in-line to the motor supply. The motor connection type (star/delta) depends on the supply mains, refer to the motor nameplate.

- (a): Supply mains
- (b): Soft starter
- (c): Induction motor

Connection In The Motor Delta Winding

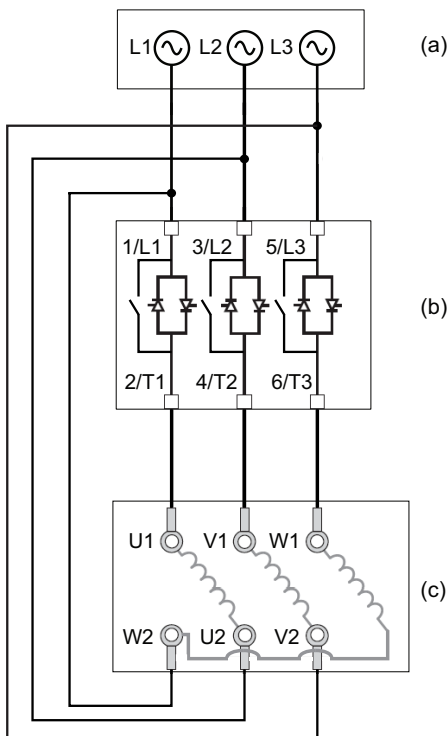

The Soft starter can be connected in the motor delta winding in series with each winding (inside the delta connection). By doing so, for the same motor power rating, the current going through the winding and the soft starter is reduced by $1.7 (\sqrt{3})$. This reduction allows to choose a soft starter with lower current rating.

Example:

Using a 400V 110kW 4 pole motor with a nominal current for the delta connection of 195A.

- In-line connection: a soft starter is selected with a current rating just above 195A, i.e. ATS490C21Y (210A) for a normal duty application.
- Inside delta connection: the current in each winding is equal to $195/\sqrt{3} = 112.5\text{A}$, ATS490C14Y is sufficient for this normal duty application.
- (a): Supply mains
- (b): Soft starter
- (c): Induction motor

For more information about the parameters enabling inside-delta usage, refer to [Connection Inside the Delta Of The Motor](#), page 156.

ATS490 and Motor Combination

What's in This Chapter

Normal Duty, Soft Starter In Line Connection, 208...690 Vac 50/60 Hz Supply 23

Normal Duty, Soft Starter Inside Delta Connection, 230...415 Vac 50/60 Hz Supply 24

Heavy Duty, Soft Starter In Line Connection, 208...690 Vac 50/60 Hz Supply 25

Heavy Duty, Soft Starter Inside Delta Connection, 230...415 Vac 50/60 Hz Supply 26

Normal Duty, Soft Starter In Line Connection, 208...690 Vac 50/60 Hz Supply

Motor									Soft starter	
Nominal motor power									Rated operational current I _e (1)	References
208 Vac	230 Vac		400 Vac	440 Vac	460 Vac	500 Vac	575 Vac	690 Vac		
HP	HP	kW	kW	kW	HP	kW	HP	kW	A	References
3	5	4	7,5	7,5	10	9	15	15	17	ATS490D17Y
5	7,5	5,5	11	11	15	11	20	18,5	22	ATS490D22Y
7,5	10	7,5	15	15	20	18,5	25	22	32	ATS490D32Y
10	-	9	18,5	18,5	25	22	30	30	38	ATS490D38Y
-	15	11	22	22	30	30	40	37	47	ATS490D47Y
15	20	15	30	30	40	37	50	45	62	ATS490D62Y
20	25	18,5	37	37	50	45	60	55	75	ATS490D75Y
25	30	22	45	45	60	55	75	75	88	ATS490D88Y
30	40	30	55	55	75	75	100	90	110	ATS490C11Y
40	50	37	75	75	100	90	125	110	140	ATS490C14Y
50	60	45	90	90	125	110	150	160	170	ATS490C17Y
60	75	55	110	110	150	132	200	200	210	ATS490C21Y
75	100	75	132	132	200	160	250	250	250	ATS490C25Y
100	125	90	160	160	250	220	300	315	320	ATS490C32Y
125	150	110	220	220	300	250	350	400	410	ATS490C41Y
150	-	132	250	250	350	315	400	500	480	ATS490C48Y
-	200	160	315	355	400	400	500	560	590	ATS490C59Y
200	250	-	355	400	500	-	600	630	660	ATS490C66Y
250	300	220	400	500	600	500	800	710	790	ATS490C79Y
350	350	250	500	630	800	630	1000	900	1000	ATS490M10Y
400	450	355	630	710	1000	800	1200	-	1200	ATS490M12Y

The nominal motor current I_n must not exceed the rated operational current I_e

(1) Current on operation at a maximum ambient temperature of 40 °C (104 °F). Above 40 °C (104 °F) and up to an ambient temperature of 60 °C (140 °F), derate current by 1% each °C (1.8 °F).

Normal Duty, Soft Starter Inside Delta Connection, 230...415 Vac 50/60 Hz Supply

Motor		Soft starter	
Nominal motor power		Rated operational current I_e (1)	References
230 Vac	400 Vac		
kW	kW	A	
7,5	15	17	ATS490D17Y
9	18,5	22	ATS490D22Y
15	22	32	ATS490D32Y
18,5	30	38	ATS490D38Y
22	45	47	ATS490D47Y
30	55	62	ATS490D62Y
37	55	75	ATS490D75Y
45	75	88	ATS490D88Y
55	90	110	ATS490C11Y
75	110	140	ATS490C14Y
90	132	170	ATS490C17Y
110	160	210	ATS490C21Y
132	220	250	ATS490C25Y
160	250	320	ATS490C32Y
220	315	410	ATS490C41Y
250	355	480	ATS490C48Y
–	400	590	ATS490C59Y
315	500	660	ATS490C66Y
355	630	790	ATS490C79Y
–	710	1000	ATS490M10Y
500	–	1200	ATS490M12Y

The nominal motor current (I_n) divide by $\sqrt{3}$ **must not exceed the rated operational current (I_e).**

(1) Current on operation at a maximum ambient temperature of 40 °C (104 °F). Above 40 °C (104 °F) and up to an ambient temperature of 60 °C (140 °F), derate current by 1% each °C (1.8 °F).

Heavy Duty, Soft Starter In Line Connection, 208...690 Vac 50/60 Hz Supply

Motor									Soft starter	
Nominal motor power									Rated operational current I _e (1)	References
208 Vac	230 Vac		400 Vac	440 Vac	460 Vac	500 Vac	575 Vac	690 Vac		
HP	HP	kW	kW	kW	HP	kW	HP	kW	A	
2	3	3	5,5	5,5	7,5	7,5	10	11	12	ATS490D17Y
3	5	4	7,5	7,5	10	9	15	15	17	ATS490D22Y
5	7,5	5,5	11	11	15	11	20	18,5	22	ATS490D32Y
7,5	10	7,5	15	15	20	18,5	25	22	32	ATS490D38Y
10	10	9	18,5	18,5	25	22	30	30	38	ATS490D47Y
-	15	11	22	22	30	30	40	37	47	ATS490D62Y
15	20	15	30	30	40	37	50	45	62	ATS490D75Y
20	25	18,5	37	37	50	45	60	55	75	ATS490D88Y
25	30	22	45	45	60	55	75	75	88	ATS490C11Y
30	40	30	55	55	75	75	100	90	110	ATS490C14Y
40	50	37	75	75	100	90	125	110	140	ATS490C17Y
50	60	45	90	90	125	110	150	160	170	ATS490C21Y
60	75	55	110	110	150	132	200	200	210	ATS490C25Y
75	100	75	132	132	200	160	250	250	250	ATS490C32Y
100	125	90	160	160	250	220	300	315	320	ATS490C41Y
125	150	110	220	220	300	250	350	400	410	ATS490C48Y
150	-	132	250	250	350	315	400	500	480	ATS490C59Y
-	200	160	315	355	400	400	500	560	590	ATS490C66Y
200	250	-	355	400	500	-	600	630	660	ATS490C79Y
250	300	220	400	500	600	500	800	710	790	ATS490M10Y
350	350	250	500	630	800	630	1000	900	1045	ATS490M12Y

The nominal motor current I_n must not exceed the rated operational current I_e

(1) Current on operation at a maximum ambient temperature of 40 °C (104 °F). Above 40 °C (104 °F) and up to an ambient temperature of 60 °C (140 °F), derate current by 1% each °C (1.8 °F).

Heavy Duty, Soft Starter Inside Delta Connection, 230...415 Vac 50/60 Hz Supply

Motor		Soft starter	
Nominal motor power		Rated operational current I_e (1)	References
230 Vac	400 Vac		
kW	kW	A	
5,5	11	12	ATS490D17Y
7,5	15	17	ATS490D22Y
9	18,5	22	ATS490D32Y
15	22	32	ATS490D38Y
18,5	30	38	ATS490D47Y
22	45	47	ATS490D62Y
30	55	62	ATS490D75Y
37	55	75	ATS490D88Y
45	75	88	ATS490C11Y
55	90	110	ATS490C14Y
75	110	140	ATS490C17Y
90	132	170	ATS490C21Y
110	160	210	ATS490C25Y
132	220	250	ATS490C32Y
160	250	320	ATS490C41Y
220	315	410	ATS490C48Y
250	355	480	ATS490C59Y
–	400	590	ATS490C66Y
315	500	660	ATS490C79Y
355	630	790	ATS490M10Y
–	710	1045	ATS490M12Y

The nominal motor current (I_n) divide by $\sqrt{3}$ **must not exceed the rated operational current (I_e)**.

(1) Current on operation at a maximum ambient temperature of 40 °C (104 °F). Above 40 °C (104 °F) and up to an ambient temperature of 60 °C (140 °F), derate current by 1% each °C (1.8 °F).

Dimensions

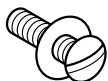

Use screws with DIN 125 washer to mount the soft starter. Tighten the fixing screws.

Altivar Soft Starter ATS490 CAD files can be downloaded from www.se.com.

ATS490D17Y, ATS490D22Y

Front, Side and Rear View

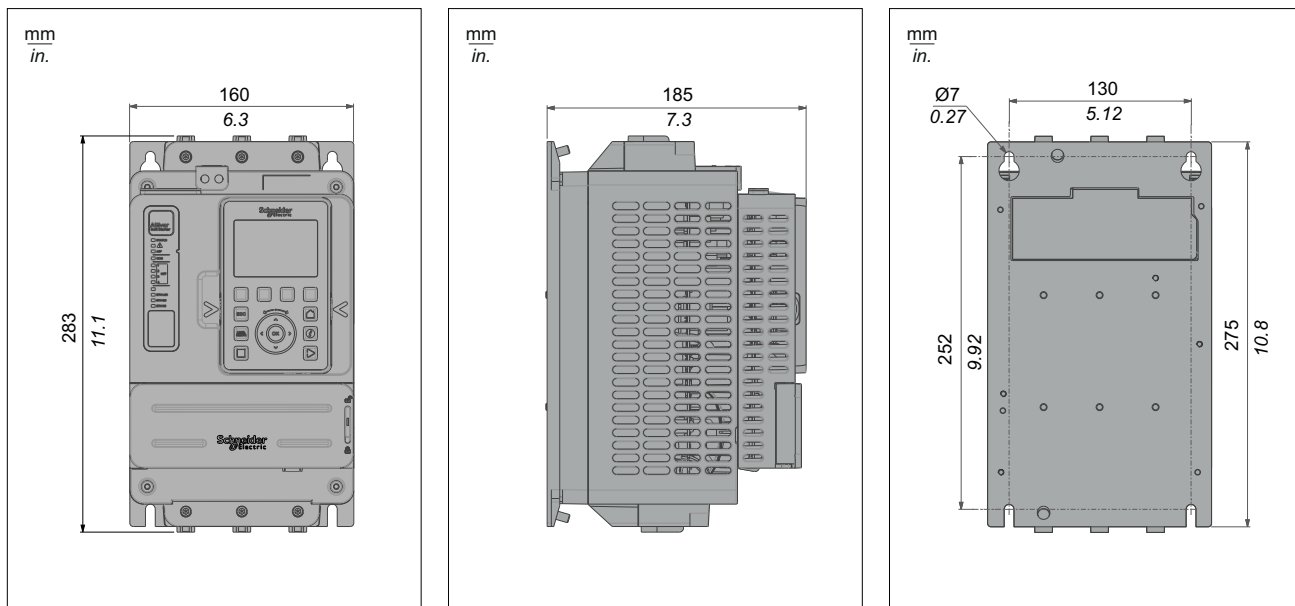

Mounting screws x 4: M6

ATS490D32Y...ATS490C11Y

Front, Side and Rear View

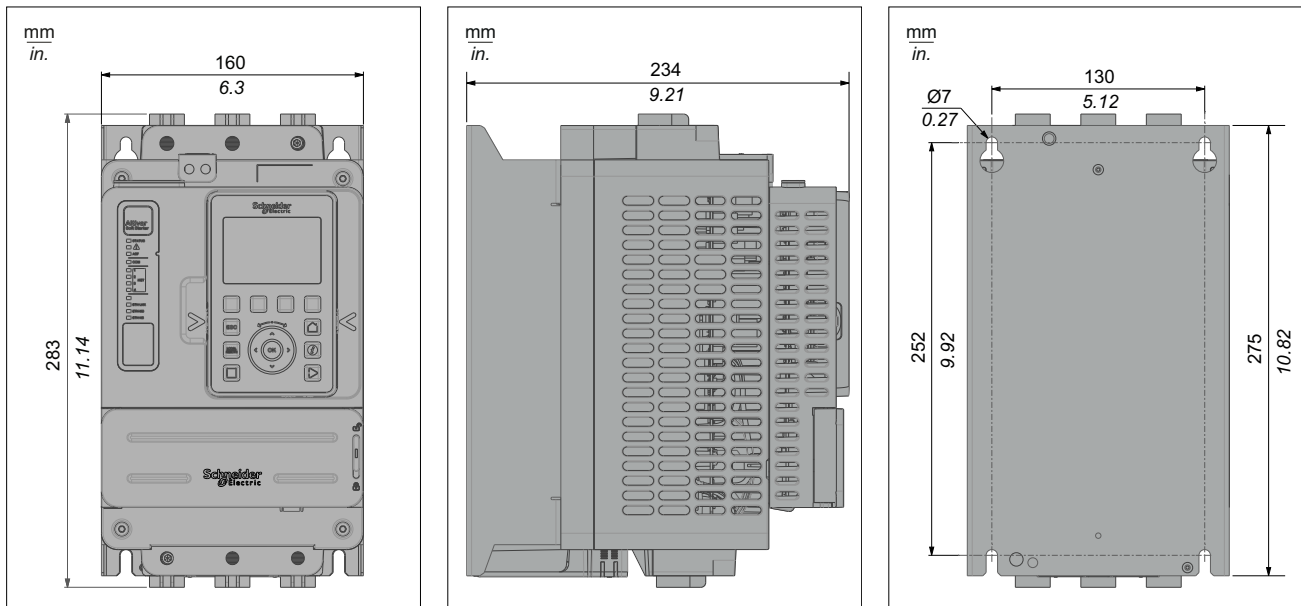

Mounting screws x 4: M6

ATS490C14Y, ATS490C17Y

Front, Side and Rear View

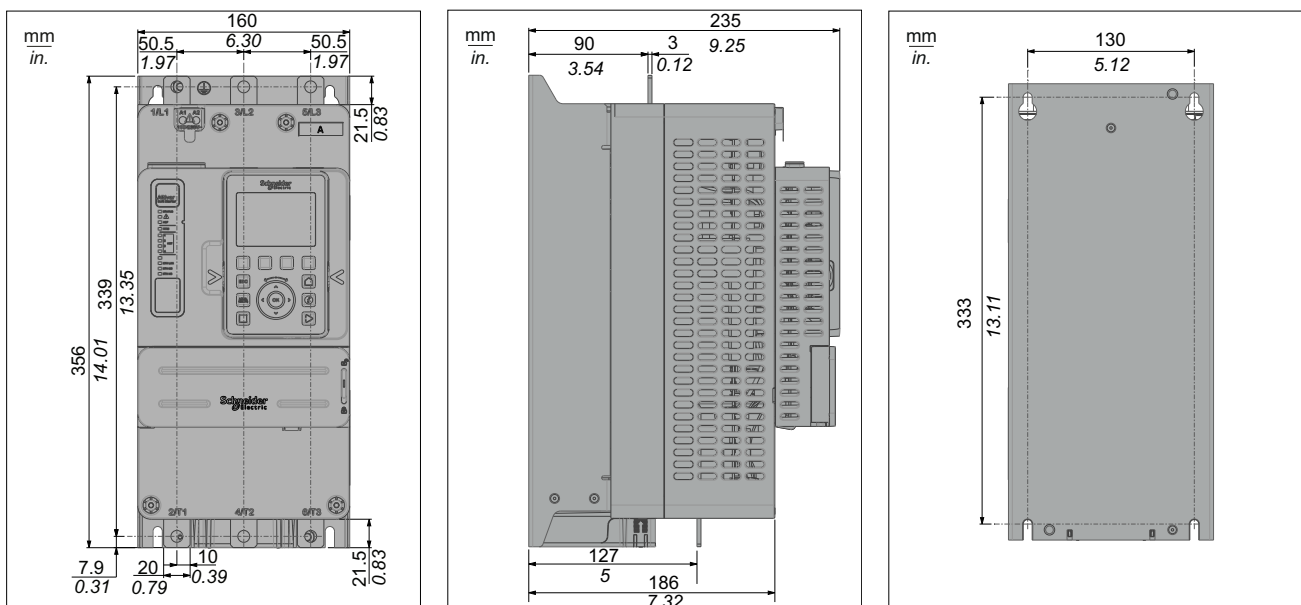

Mounting screws x 4: M6

ATS490C21Y...ATS490C41Y

Front, Side and Rear View

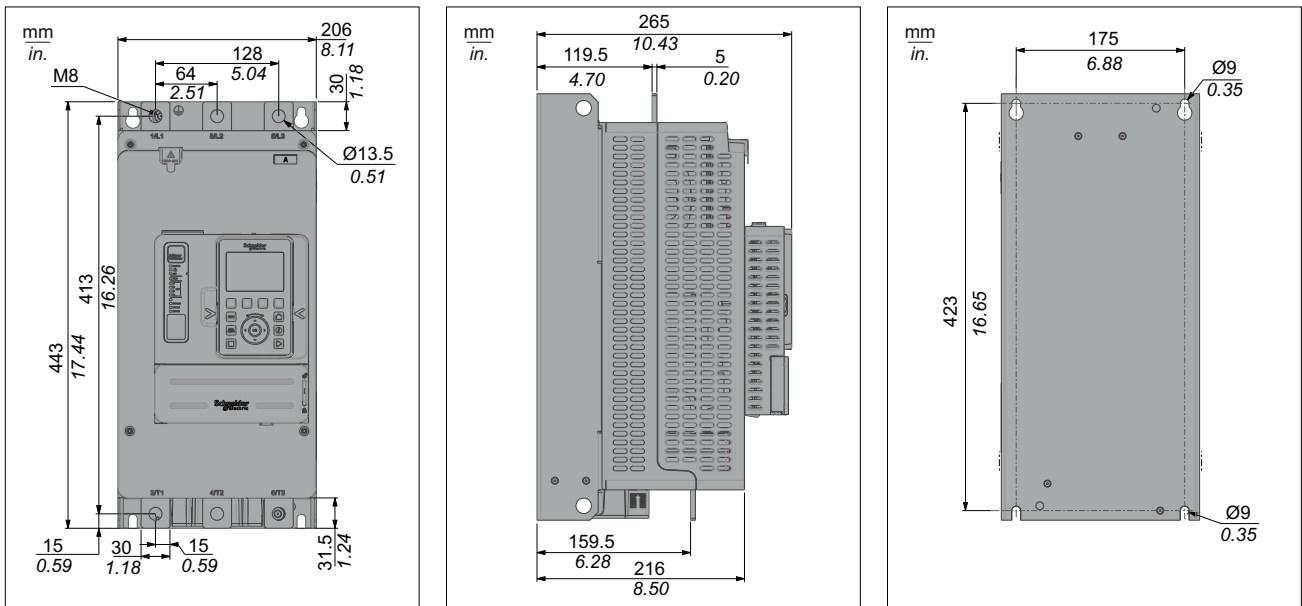

Mounting screws x 4: M8

ATS490C48Y...ATS490C66Y

Front, Side and Rear View

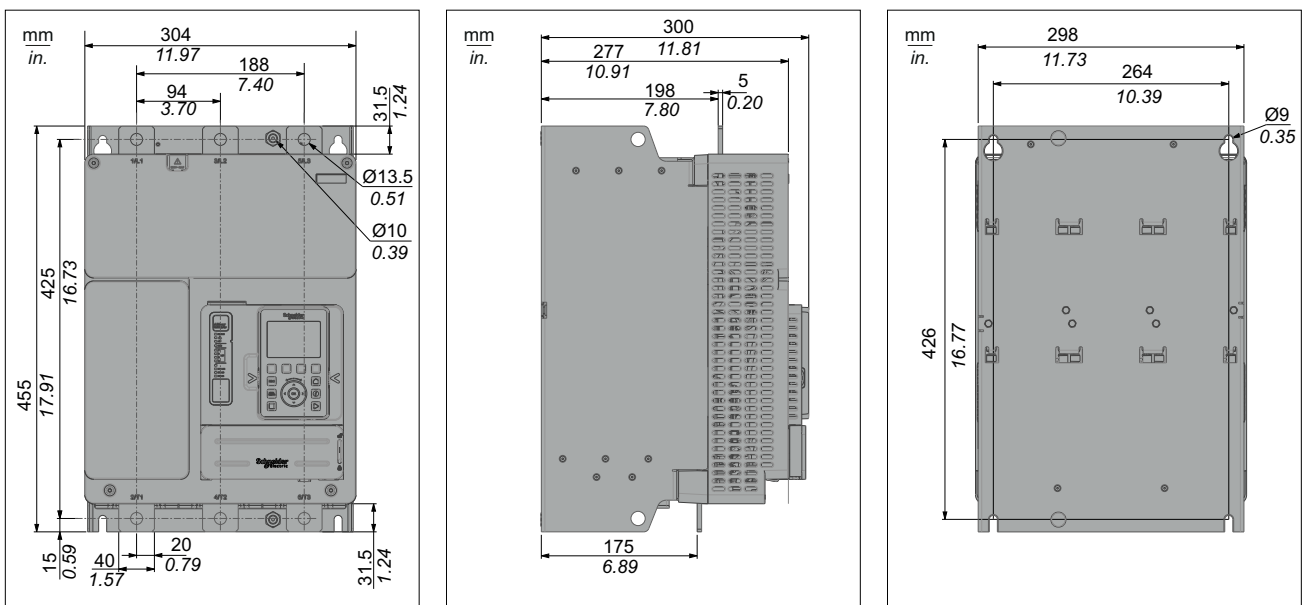

Mounting screws x 4: M8

ATS490C79Y...ATS490M12Y

Front, Side and Rear View

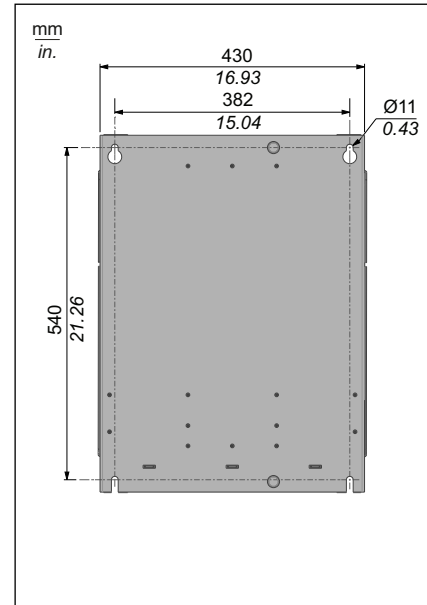
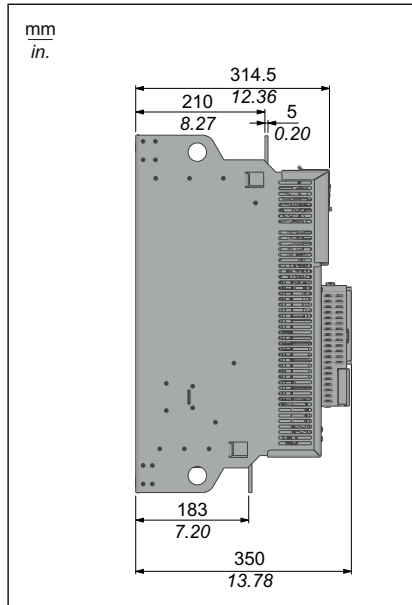
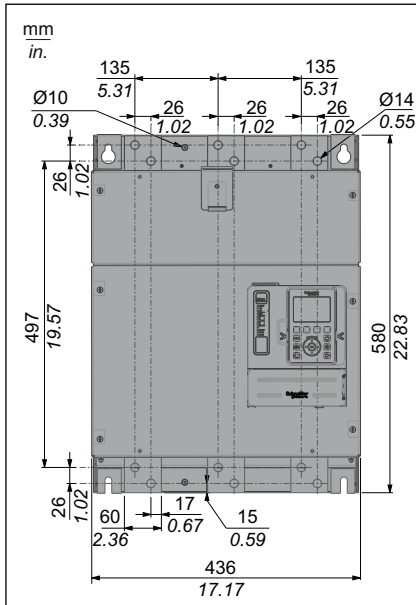

Mounting screws x 4: M10

Mounting Position

The soft starter is designed to be mounted inside cabinets vertically at $\pm 10^\circ$ for cooling purposes.

Respect the minimum clearances so that the cooling air can circulate from the bottom to the top of the soft starter. The minimum clearances apply to any device close to the soft starter such as circuit breakers, fuses and contactors.

Do not install the soft starter above heating elements.

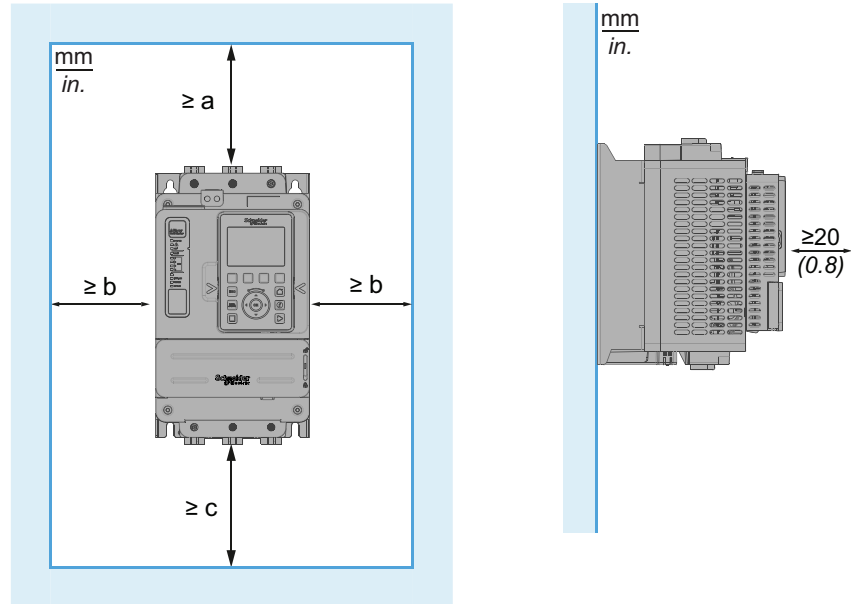

NOTE: Refer to the table below

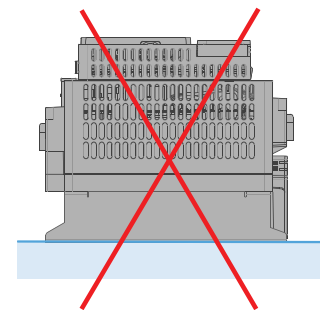
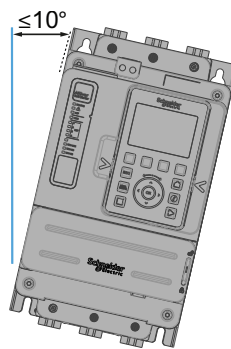

References	Minimum free space above the Soft Starter (a)	Minimum free space on the sides of the Soft Starter (b)	Minimum free space below the Soft Starter (c)
	mm (in)	mm (in)	mm (in)
ATS490D17Y...D47Y	55 (2.1)	20 (0.8)	50 (2)
ATS490D62Y...C17Y	75 (3)	10 (0.4)	60 (2.4)
ATS490C21Y...C41Y	85 (3.3)	10 (0.4)	60 (2.4)
ATS490C48Y...M12Y	100 (4)	20 (0.8)	75 (3)

Enclosure Thermal Design

Conductive foreign objects may cause parasitic voltage.

DANGER

ELECTRIC SHOCK AND/OR UNANTICIPATED EQUIPMENT OPERATION

- Keep foreign objects such as chips, screws or wire clippings from getting into the product.
- Verify correct seat of seals and cable entries in order to avoid deposits and humidity.

Failure to follow these instructions will result in death or serious injury.

The temperature of the products described in this manual may exceed 80 °C (176 °F) during operation.

WARNING

HOT SURFACES

- Ensure that any contact with hot surfaces is avoided.
- Do not allow flammable or heat-sensitive parts in the immediate vicinity of hot surfaces.
- Verify that the product has sufficiently cooled down before handling it.
- Verify that the heat dissipation is sufficient by performing a test run under maximum load conditions.

Failure to follow these instructions can result in death, serious injury, or equipment damage.

Mounting in an Enclosure

⚠️ ⚠️ DANGER

HAZARD OF ELECTRIC SHOCK, EXPLOSION, OR ARC FLASH

These products are open devices and must be mounted in a suitable enclosure.

Failure to follow these instructions will result in death or serious injury.

Use the enclosure manufacturers' specifications for proper sizing based on thermal considerations. It is necessary to add up the power dissipated by each device in the enclosure.

		Enclosure type	
		General purpose metal to reach IP23	Dust and damp-proof metal to reach IP54 / NEMA12
<p>θ_e = external ambient temperature</p> <p>θ_i = internal ambient temperature of the enclosure</p>			
Air circulation	Install air inlet	If air inlet is not adequate, install a forced ventilation unit, with a filter if necessary	<p>Do not use insulated or non-metallic enclosures as they have poor thermal conduction. Provide a stirring fan to circulate air inside the enclosure and to help prevent hot spots in the soft starter.</p> <p>This allows operation of the soft starter in an enclosure with a maximum internal temperature of 60 °C (140 °F)</p>
Temperature around the soft starter	<ul style="list-style-type: none"> • -10...40 °C (14...104 °F) without derating • 40...60 °C (104 ... 140 °F) with rated current (I_e) derating of 1% per degree <p>Ensure that the ambient temperature around the soft starters does not exceed this limit.</p>		

Estimation of power to be dissipated in the enclosure at 40°C

Formula:

$$P0 = (P1 - (P1 \times C1) - (P1 \times C2)) \times C3^{\wedge}C4$$

With :

- P0 = P_{Losses during starting}
- P1 = P_{Losses at In at 40°C}
- C1 = Coef_{Temperature Derating}; Ambient temperatures around the device between 40°C (104 °F) to 60°C (140°F) reduce current by 1% per °C (1.8°F).
- C2 = Coef_{Altitude Derating}; Maximum operating altitude between 2000...4800m (6600...15700ft) reduce current by 1% each additional 100m (330ft).
- C3 = Coef_{%In}
- C4 = Power Coefficient

Example of calculating an estimation of the power to be dissipated in the enclosure:

For an **ATS490M12Y**:

- P1 = 3392 W
- at 60°C C1 = 20 x 0.01 = 0.2
- at 2500m C2 = 5 x 0.01 = 0.05
- at 400% In C3 = 4
- C4 = 1.28

$$P0 = (3392 - (3392 \times 0.2) - (3392 \times 0.05)) \times 4^{\wedge}1.28 = 15003 \text{ W}$$

Reference	Power dissipated at nominal load (W)		Power loss during starting (W) at In during 13s P1	Power loss during starting (W) at 400%In during 13s	Fan consumption (W)	Power Coefficient C4	Minimum air flow rate required	
	normal duty	heavy duty					m³/hour	ft³/min
ATS490D17Y	2	-	41	162	NA (no fan)	1,12	3	1,77
ATS490D22Y	4	2	54	260		1,15	3	1,77
ATS490D32Y	8	4	81	417		1,2	3	1,77
ATS490D38Y	11	8	89	439		1,17	3	1,77
ATS490D47Y	17	11	112	576		1,2	3	1,77
ATS490D62Y	7	17	143	683		1,14	3	1,77
ATS490D75Y	11	7	192	929		1,16	31	18,25
ATS490D88Y	15	11	228	1134	7,2	1,18	31	18,25
ATS490C11Y	32	15	285	1533		1,24	31	18,25
ATS490C14Y	26	32	325	1710		1,22	50	29,43
ATS490C17Y	38	26	404	2219		1,25	50	29,43
ATS490C21Y	48	38	520	2873	19,2	1,26	106	62,39
ATS490C25Y	64	48	602	3142		1,21	106	62,39
ATS490C32Y	60	64	807	4609		1,28	106	62,39
ATS490C41Y	99	60	1030	5843		1,28	106	62,39
ATS490C48Y	108	99	1273	6370	57,5	1,18	238	140,08
ATS490C59Y	164	108	1595	8310		1,22	238	140,08
ATS490C66Y	205	164	1806	9637		1,23	238	140,08
ATS490C79Y	157	205	2126	10977	43,2	1,21	526	309,59
ATS490M10Y	251	157	2619	15003		1,24	526	309,59
ATS490M12Y	361	251	3392	19271		1,28	526	309,59

NOTE: Power dissipated at Ready state (current independent) is 19 W.

NOTE: The fans turn On when a RUN command is applied.

IP20 kits and Protective Covers

IP20 kits

See the catalog and search for associated IP20 kits:

Corresponding soft starter	Reference
ATS490C14Y, ATS490C17Y	VW3G4701
ATS490C21Y...ATS490C41Y	VW3G4702
ATS490C48Y...ATS490C66Y	VW3G4703

Protective Covers: ATS490C79Y...ATS490M12Y

It is possible to limit direct access to the power terminals by installing protective covers for the following references:

- ATS490C79Y
- ATS490M10Y
- ATS490M12Y

Protective covers help to add a guarding to the IP00 power terminals to reduce accidental contact.

⚠️⚠️ DANGER

HAZARD OF ELECTRIC SHOCK OR ARC FLASH

- Do not consider that the degree of protection is modified if the protective covers are added to the device.
- Before performing any work on and around the device, you must continue to follow the instructions given in this manual.

Failure to follow these instructions will result in death or serious injury.

NOTICE

DAMAGE TO THE DEVICE

- Follow the instructions given in this section to design and install the protective covers.
- Do not exceed the maximum limits specified.

Failure to follow these instructions can result in equipment damage.

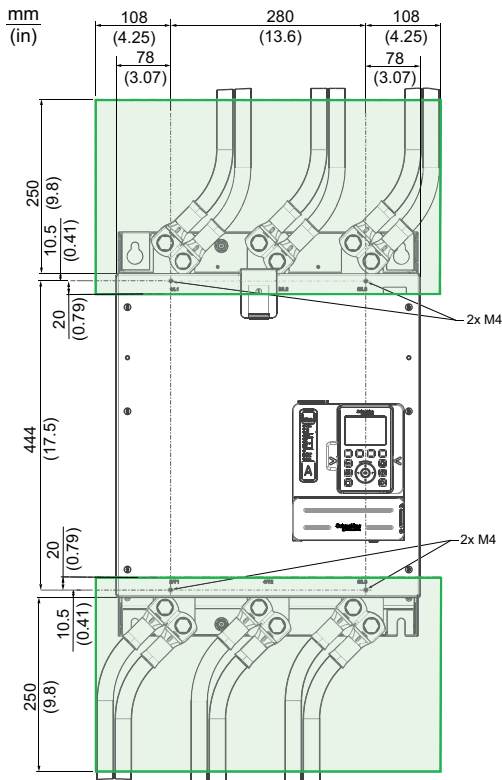

To dimension the protective covers for ATS490C79Y...
ATS490M12Y, it is required to respect the following limits:

- Protective cover material must be polymethyl methacrylate (PMMA).
- M4 fixing screws.
- Maximum 5 mm (0,2 inch) thick.
- For a longer length than 250 mm, it is required to use support points on the cabinet.

Application Diagrams

Six application diagrams are provided in this manual:

1. Connection In Line, No Line Contactor, Type 1 or 2 Coordination, 2-wire or 3-wire control.
2. Connection In Line, With Line Contactor, Type 1 or 2 Coordination, 2-wire or 3-wire control.
3. Connection In Line, With Line Contactor, Type 1 or 2 Coordination, 2-wire control.
4. Connection Inside the Delta, With Line, Type 1 and 2 Coordination, 2-wire or 3-wire.
5. Connection Inside the Delta, With Line, Type 1 or 2 Coordination, 2-wire or 3-wire.
6. Connection to a Two Speeds Motor With Two Sets of Parameters, Type 1 or 2 Coordination, 2-wire Control.
7. All details related to the **STO safety function** activation are given in the ATS490 Embedded Safety Function Manual PKR63419.

1. Connection In Line, No Line Contactor, Type 1 or 2 Coordination, 2-wire or 3-wire control

Controlled by Power ON and Power OFF push-buttons

It requires a local intervention to restart by pressing **S5** or **S6** (if TCT = TRN) push button after the error reset.

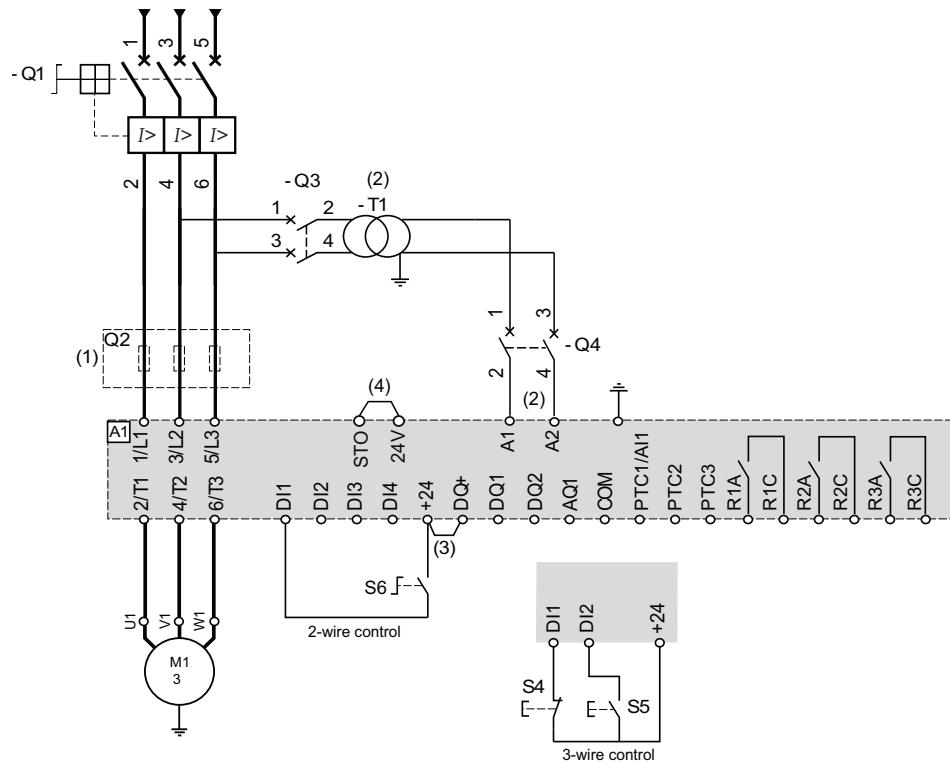

- (1) Installation of additional fast-acting fuses is mandatory to upgrade to type 2 coordination according to IEC 60947-4-2.
 - (2) The transformer must supply 110...230 Vac +10% - 15%, 50/60Hz.
 - (3) 24Vdc supply on DQ+ if usage of DQ outputs.
 - (4) STO Safe Torque Off
- 3-wire control and 2-wire control. Refer to RUN and STOP Management, page 49.

Designation	Component	Description
Q1	Circuit breaker	Short circuit protection device for the motor
Q2	Fast acting fuses	Short circuit protection device of the soft starter to be used only when type 2 coordination
Q3	Circuit breaker	Short circuit protection device for the primary of the transformer
Q4	Circuit breaker	Short circuit protection device for the secondary of the transformer
S4	Normally close contact push-button	STOP command for 3-wire control
S5	Normally open contact push-button	RUN command for 3-wire control
S6	Selector switch, 2 positions, stay-put, normally open contact	RUN/STOP command for 2-wire control

2. Connection In Line, With Line Contactor, Type 1 or 2 Coordination, 2-wire or 3-wire control

Line contactor controlled by Power ON and Power OFF push-buttons or on detected error

This application diagram is well adapted to local control using inputs of ATS490. It requires a local intervention by pressing **S3** push button after the error reset even in case of remote control to have the mains supply at the soft starter.

Use relay output R1 set to **[Operating State Fault]** (factory setting) to turn Off the soft starter when an error is triggered by the device. A Stop by **S6** or **S4** does not open the line contactor.

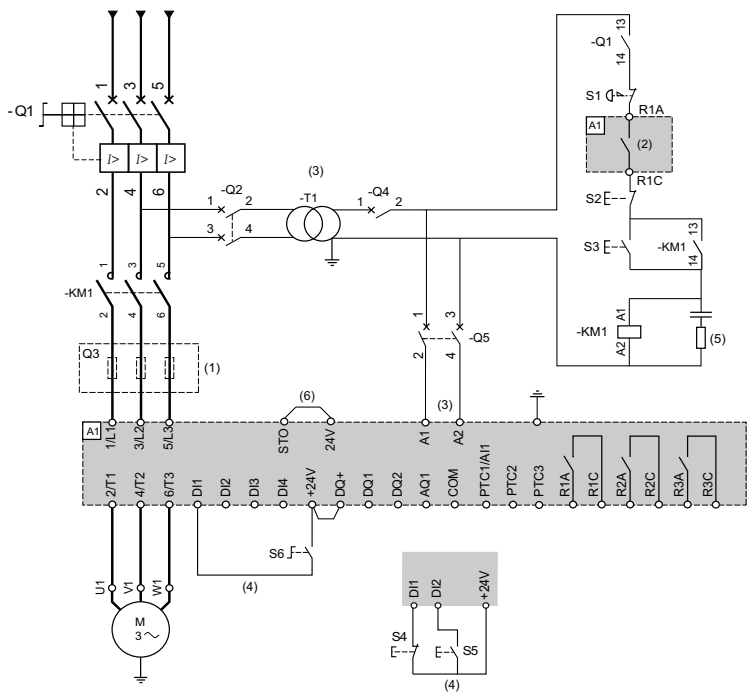

- (1) Installation of additional fast-acting fuses is mandatory to upgrade to type 2 coordination according to IEC 60947-4-2.
- (2) Take into account the electrical characteristics of the relays, refer to Control Terminal Characteristics, page 46.
- (3) The transformer must supply 110...230 Vac +10% - 15%, 50/60Hz.
- (4) 3-wire control and 2-wire control. Refer to RUN and STOP Management, page 49.
- (5) To select the appropriate voltage surge suppressor refer to Relay Contacts Wiring, page 52.
- (6) STO Safe Torque Off

Designation	Component	Description
Q1	Circuit breaker	Short circuit protection device for the motor
Q2	Circuit breaker	Short circuit protection device for the primary of the transformer
Q3	Fast acting fuses	Short circuit protection device of the soft starter to be used only when type 2 coordination
Q4	Circuit breaker	Short circuit protection device for the secondary of the transformer
Q5	Circuit breaker	Short circuit protection device for the control part of the soft starter
KM1	Contactor	Line contactor
S1	Emergency Stop push-button	Emergency Stop to de-energized KM1 line contactor
S2	Normally close push-button	Power OFF
S3	Normally open push-button	Power ON
S4	Normally close contact push-button	STOP command for 3-wire control
S5	Normally open contact push-button	RUN command for 3-wire control
S6	Selector switch, 2 positions, stay-put, normally open contact	RUN/STOP command for 2-wire control

3. Connection In Line, With Line Contactor, Type 1 or 2 Coordination, 2-wire control

Line contactor controlled based on RUN & STOP or on detected error. Stop following [Type of stop] **STT**

Simplified application diagram for local control using inputs of ATS490. Use relay output R1 set to [Mains Contactor] to remove the mains supply on the soft starter when an error is detected or on STOP command.

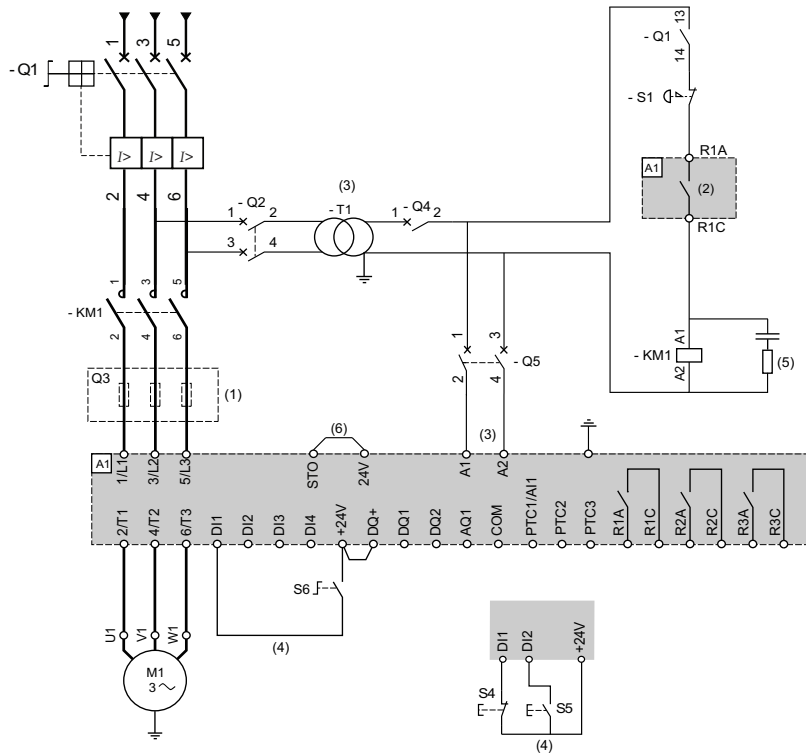

- (1) Installation of additional fast-acting fuses is mandatory to upgrade to type 2 coordination according to IEC 60947-4-2.
- (2) Take into account the electrical characteristics of the relays, refer to Control Terminal Characteristics, page 46.
- (3) The transformer must supply 110...230 Vac +10% - 15%, 50/60Hz.
- (4) 2-wire control and 3-wire control. Refer to RUN and STOP Management, page 49.
- (5) To select the appropriate voltage surge suppressor refer to Relay Contacts Wiring, page 52.
- (6) STO Safe Torque Off

Designation	Component	Description
Q1	Circuit breaker	Short circuit protection device for the motor
Q2	Circuit breaker	Short circuit protection device for the primary of the transformer
Q3	Fast acting fuses	Short circuit protection device of the soft starter to be used only when type 2 coordination according to IEC 60947-4-2 is required
Q4	Circuit breaker	Short circuit protection device for the secondary of the transformer
Q5	Circuit breaker	Short circuit protection device for the control part of the soft starter
KM1	Contactor	Line contactor
S1	Emergency Stop push-button	Emergency Stop to de-energized KM1 line contactor
S4	Normally close contact push-button	STOP command for 3-wire control
S5	Normally open contact push-button	RUN command for 3-wire control
S6	Selector switch, 2 positions, stay-put, normally open contact	RUN/STOP. command for 2-wire control

4. Connection Inside the Delta, Type 1 and 2 Coordination, 2-wire or 3-wire

Line contactor controlled based on RUN and STOP command or detected error

This application diagram is well adapted to local control using inputs of ATS490. It requires a local intervention by pressing **S3** push button after the error reset even in case of remote control to have the mains supply at the soft starter. Use relay output R1 set to **[Operating State Fault]** (factory setting). A Stop by **S6** or **S4** does not open the line contactor. Set **[Inside Delta]** to **[Yes]**.

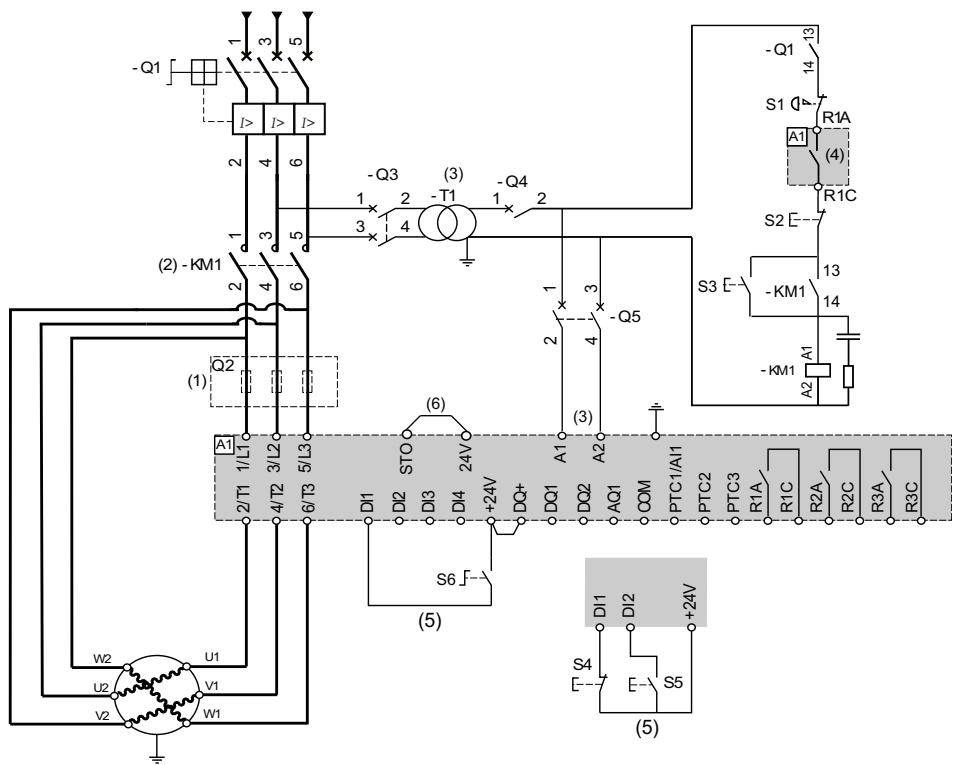

- (1) Installation of additional fast-acting fuses is mandatory to upgrade to type 2 coordination according to IEC 60947–4–2.
- (2) KM1 is mandatory to avoid uncontrolled voltage on the motor
- (3) The transformer must supply 110...230 Vac +10% — 15%, 50/60Hz.
- (4) Take into account the electrical characteristics of the relays, especially when connecting to high rating contactor. Refer to Control Terminal Characteristics, page 46.
- (5) 3–wire control, 2–wire control. Refer to RUN and STOP Management, page 49.
- (6) STO Safe Torque Off
- To select the appropriate voltage surge suppressor refer to Relay Contacts Wiring, page 52.

Designation	Component	Description
Q1	Circuit breaker	Short circuit protection device for the motor
Q2	Fast acting fuses	Short circuit protection device of the soft starter to be used only when type 2 coordination according to IEC 60947-4-2 is required
Q3	Circuit breaker	Short circuit protection device for the primary of the transformer
Q4	Circuit breaker	Short circuit protection device for the secondary of the transformer
Q5	Circuit breaker	Short circuit protection device for the control part of the soft starter
KM1	Contactors	Line contactor
S1	Emergency Stop push-button	Emergency Stop to de-energized KM1 line contactor
S2	Normally close push-button	Power OFF
S3	Normally open push-button	Power ON
S4	Normally close contact push-button	STOP command for 3-wire control
S5	Normally open contact push-button	RUN command for 3-wire control
S6	Selector switch, 2 positions, stay-put, normally open contact	RUN/STOP. command for 2–wire control

5. Connection Inside the Delta, Type 1 or 2 Coordination, 2-wire or 3-wire

Line contactor controlled based on RUN and STOP command or detected error

Simplified application diagram for local control using inputs of ATS490. Use relay output R1 set to **[Mains Contactor]** to remove the mains supply on the soft starter when an error is detected or on STOP command. Set **[Inside Delta]** to **[Yes]**.

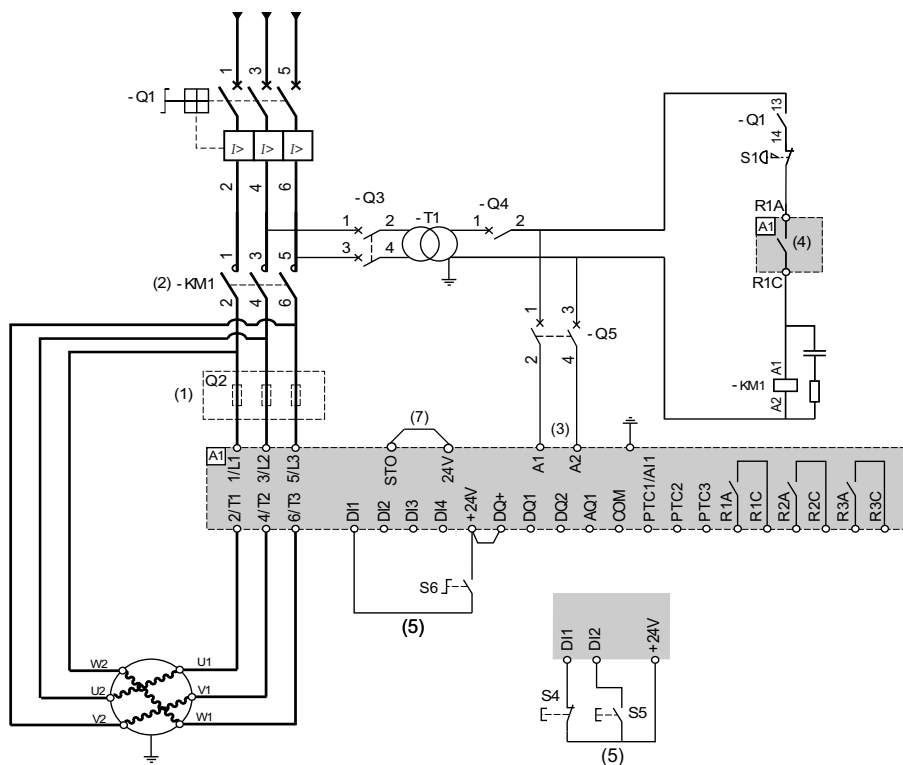

- (1) Installation of additional fast-acting fuses is mandatory to upgrade to type 2 coordination according to IEC 60947-4-2.
- (2) KM1 is mandatory to avoid uncontrolled voltage on the motor
- (3) The transformer must supply 110...230 Vac +10% — 15%, 50/60Hz.
- (4) Take into account the electrical characteristics of the relays, refer to Control Terminal Characteristics, page 46.
- (5) Take into account the electrical characteristics of the relays, especially when connecting to high rating contactor. Refer to Control Terminal Characteristics, page 46.
- (6) 3-wire control and 2-wire control. Refer to RUN and STOP Management, page 49.
- (7) STO Safe Torque Off
- To select the appropriate voltage surge suppressor refer to Relay Contacts Wiring, page 52.

Designation	Component	Description
Q1	Circuit breaker	Short circuit protection device for the motor
Q2	Fast acting fuses	Short circuit protection device of the soft starter to be used only when type 2 coordination
Q3	Circuit breaker	Short circuit protection device for the primary of the transformer
Q4	Circuit breaker	Short circuit protection device for the secondary of the transformer
Q5	Circuit breaker	Short circuit protection device for the control part of the soft starter
KM1	Contactors	Line contactor
S1	Emergency Stop push-button	Emergency Stop to de-energized KM1 line contactor
S4	Normally close contact push-button	STOP command for 3-wire control and power Off
S5	Normally open contact push-button	RUN command for 3-wire control and power On
S6	Selector switch, 2 positions, stay-put, normally open contact	RUN/STOP command for 2-wire control

6. Connection to a Two Speeds Motor With Two Sets of Parameters, Type 1 or 2 Coordination, 2-wire Control

Line contactor controlled based on RUN and STOP command or detected error

Use relay output R1 set to [Mains Contactor] to remove the mains supply on the soft starter when an error is detected or on STOP command. Set DI3 to [2nd Mot Param Set] and R2 to [2nd Mot Param Active].

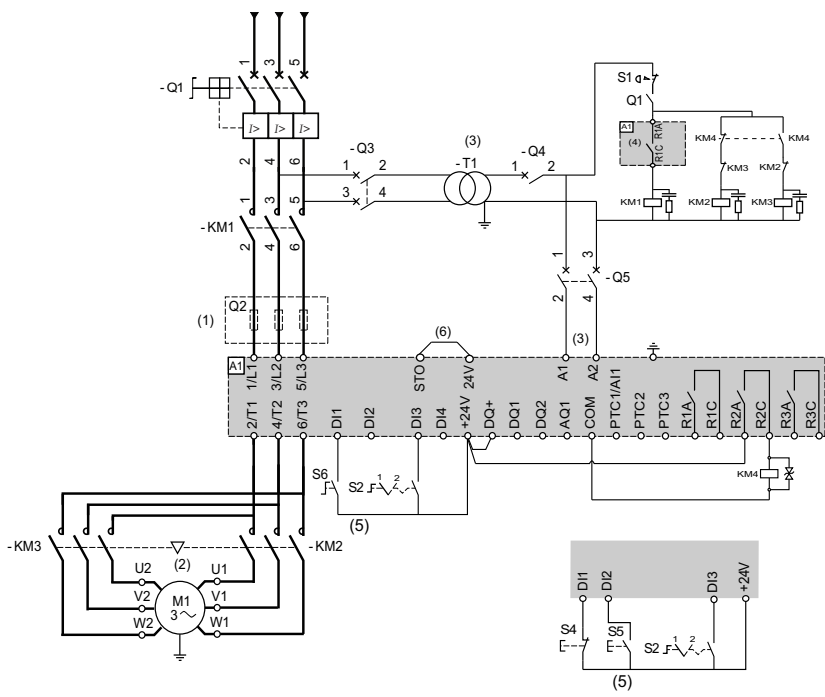

- (1) Installation of additional fast-acting fuses is mandatory to upgrade to type 2 coordination according to IEC 60947-4-2.
- (2) Ensure that the directions of motor rotation correspond for both speeds.
- (3) The transformer must supply 110...230 Vac +10% — 15%, 50/60Hz.
- (4) Take into account the electrical characteristics of the relays, especially when connecting to high rating contactor. Refer to Control Terminal Characteristics, page 46.
- (5) 3-wire control and 2-wire control. Refer to RUN and STOP Management, page 49.
- (6) STO Safe Torque Off
- To select the appropriate voltage surge suppressor refer to Relay Contacts Wiring, page 52.

Designation	Component	Description
Q1	Circuit breaker	Short circuit protection device for the motor
Q2	Fast acting fuses	Short circuit protection device of the soft starter to be used only when type 2 coordination
Q3	Circuit breaker	Short circuit protection device for the primary of the transformer
Q4	Circuit breaker	Short circuit protection device for the secondary of the transformer
Q5	Circuit breaker	Short circuit protection device for the control part of the soft starter
KM1	Contactors	Line contactor
KM2	Contactors	Low speed contactor
KM3	Contactors	High speed contactor
KM4	Contactors	Motor speed selection. 24 Vdc coil.
S1	Emergency Stop push-button	Emergency Stop to de-energized KM1 line contactor
S2	Selector switch, 2 positions, stay-put	Position 1 = Low speed, position 2 = High speed
S4	Normally close contact push-button	STOP command for 3-wire control and power Off
S5	Normally open contact push-button	RUN command for 3-wire control and power On
S6	Selector switch, 2 positions, stay-put, normally open contact	RUN/STOP command for 2-wire control

Type of coordination

The EN/IEC 60947-4-2 make a distinction between two different types of coordination, which are designated coordination type 1 and coordination type 2.

Type 1 coordination:

Type 1 coordination requires that, under short-circuit conditions, the contactor or starter shall cause no danger to persons or installation and may not be suitable for further service without repair and replacement of parts.

Type 2 coordination:

Type 2 coordination requires that, under short-circuit conditions, the contactor or starter shall cause no danger to persons or installation and shall be suitable for further use. The risk of contact welding is recognized, in which case the manufacturer shall indicate the measures to be taken as regards the maintenance of the equipment.

NOTE: Use of an Short-Circuit Protective Device not in compliance with the manufacturer's recommendations can invalidate the coordination.

Refer to the Schneider Electric Catalogue to select the appropriate coordination components.

Thermal monitoring

- Soft Starter Thermal monitoring is provided by the NTC sensor fitted on the heatsink and a function calculating the temperature rise of the thyristors.
- The Soft Starter will help to protect the motor and the cables against overloads. If this monitoring function is disabled, external thermal monitoring must be provided.

Control Block Wiring Diagram

⚡ ⚠ DANGER

ELECTRIC SHOCK CAUSED BY INCORRECT POWER SUPPLY UNIT

The +24 Vdc supply voltage is connected with many exposed signal connections in the device.

- Use a power supply unit that meets the PELV (Protective Extra Low Voltage) requirements.

Failure to follow these instructions will result in death or serious injury.

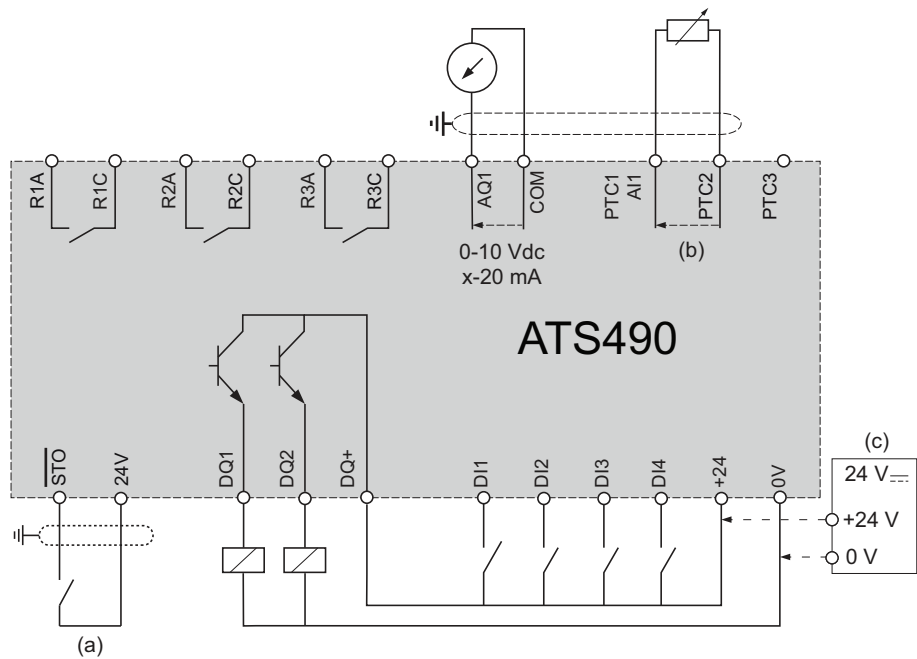

- (a): STO Safe Torque Off
- (b): 2 wire PTC/PT100/PT1000/KTY
- (c): Optional, in case of +24 External Supply usage

PT100, PT1000 Thermal Probe 3 Wires:

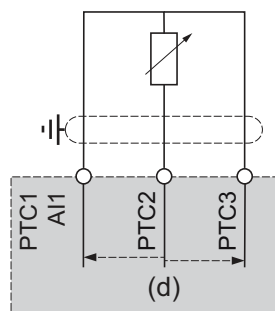

- (d): 3 wire PT100/PT1000

Control Terminal Characteristics

The ATS490 can start and stop the motor in “2–wire control” or “3–wire control”, depending on how the DI terminals are wired and the software configuration. Simple diagrams explaining those modes and how to wire the terminals, are available at RUN and STOP Management, page 49.

Complete application diagrams including power and control connections are available at Application Diagrams, page 37.

To control the motor, the ATS490 must be supplied in 110...230 Vac via the terminals A1 and A2.

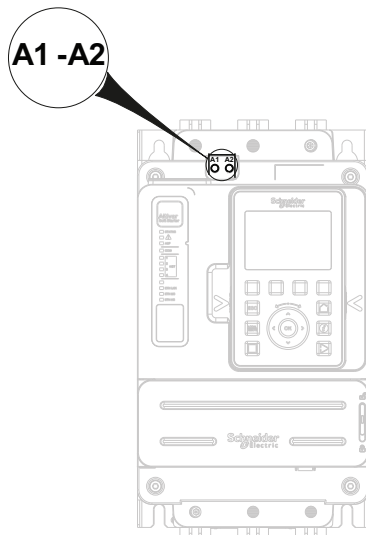

<i>NOTICE</i>
INCORRECT VOLTAGE
<ul style="list-style-type: none"> Supply the control supply terminals A1 / A2 within a range of 110...230 Vac only
Failure to follow these instructions can result in equipment damage.

To maintain communication with the soft starter when A1 and A2 are absent, the ATS490 control part can be supplied in 24 Vdc via the terminal +24.

Reference	Apparent power (VA) for control supply A1/A2
ATS490D17Y...D62Y	70
ATS490D75Y...C17Y	80
ATS490C21Y...C41Y	90
ATS490C48Y...C66Y	280
ATS490C79Y...M12Y	300

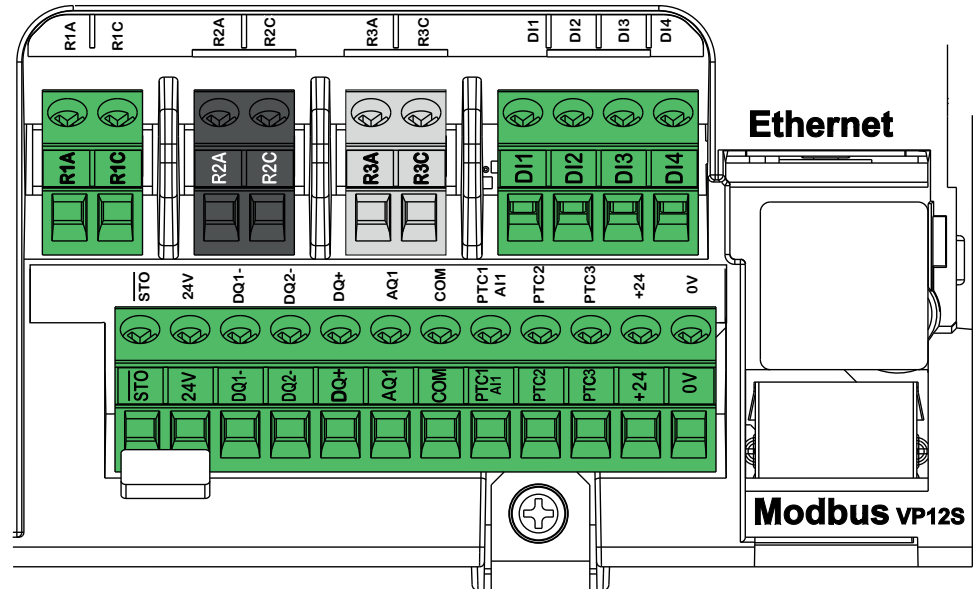

Control terminal wires specifications :

Tightening torque max N.m (lbf.in)	Min relay output wire cross section mm ² (AWG)	Other min wire cross section mm ² (AWG)	Max connection capacity mm ² (AWG)	Stripping length mm (in)	
				Min	Max
0.5 (4.4)	0.75 (18)	0.5 (20)	1.5 (16)	5.5 (0.2)	7.5 (0.3)

Those values are given for a single wire per terminal. Use a shunt to create a bridge between terminals if necessary.

Control supply terminals A1/A2 wires specifications :

Tightening torque max N.m (lbf.in)	Min wire cross section mm ² (AWG)	Max connection capacity mm ² (AWG)	Stripping length mm (in)	
			Min	Max
0.5 (4.4)	0.5 (20)	2.5 (14)	5.5 (0.2)	7.5 (0.3)

Terminals	Function	I/O	Characteristics
A1 A2	Control power supply	I	<ul style="list-style-type: none"> 110...230 Vac +10% – 15%, 50/60 Hz
R1A R1C	Programmable NO relay R1 – Assigned to Operating state Fault by default	O	<ul style="list-style-type: none"> Max voltage: 250 Vac. Min. switching capacity: 100mA for 12Vdc Max. switching capacity on inductive load following IEC60947-2: <ul style="list-style-type: none"> 2A/250Vac for AC15 100 000 cycles 2A/30Vdc for DC13 150 000 cycles Inductive load must be equipped with a voltage surge suppression device according to AC or DC operation with total energy dissipation greater than the inductive energy stored in the load. Refer to sections Output Relay with Inductive AC Loads, page 52 and Output Relay with Inductive DC Loads, page 53.
R2A R2C	Programmable NO relay R2	O	
R3A R3C	Programmable NO relay R3	O	

Terminals	Function	I/O	Characteristics
DI1	Digital Input 1	I	<ul style="list-style-type: none"> 4 x 24 Vdc digital inputs with 4.4 kΩ impedance U_{max} = 30 V I_{max} = 7 mA State 1: U > 11 V and I > 5 mA State 0: U < 5 V and I < 2 mA Response time: 2 ms ± 0.5 ms max
DI2	Digital Input 2	I	
DI3	Digital Input 3	I	
DI4	Digital Input 4	I	
0V	Common for +24	I/O	<ul style="list-style-type: none"> 0 V
+24	Supply for digital output	I/O	<ul style="list-style-type: none"> U_{min}: 19 Vdc U_{nominal}: 24 Vdc U_{max}: 30 Vdc I_{max}: 200 mA Isolated and protected against short-circuits and overloads, maximum current 200 mA. Can be used to supply the control block with an external 24Vdc supply if A1 and A2 are absent to keep communication with the product. <p>NOTE: The +24 terminal does not entirely substitute supply from A1 and A2. The motor cannot be controlled if you supply the ATS490 via only the +24 terminal. To control the motor, the ATS490 must be supplied via A1/A2 and the mains according to the application diagrams, page 37.</p>
DQ+	Digital output supply	O	24 Vdc digital output supply
DQ1	Programmable digital output 1	O	<ul style="list-style-type: none"> 2 open collector outputs compatible with level 1 PLC, IEC 65A-68 standard. Power supply +24 Vdc (min. 12 Vdc, max 30 Vdc) Max. current 100 mA per output with an external source Max frequency: 1kHz
DQ2	Programmable digital output 2	O	
AQ1	Programmable analog Output 1	O	<ul style="list-style-type: none"> Available signal: <ul style="list-style-type: none"> 0 —10 Vdc. Minimum load impedance 470 Ω 0 —20 mA ; 4 —20 mA, can be configured to custom value. Maximum load impedance 500 Ω Accuracy ± 1% for temperature range —10 to +60°C Resolution: 10 bits Linearity: ± 0.2% Sampling time: 5 ms + 1 ms maximum
COM	I/O common	I/O	<ul style="list-style-type: none"> 0 V
PTC1 / AI1	Motor thermal sensor connection	I	<ul style="list-style-type: none"> Configurable for PTC, PT100 (2/3 wires), PT1000 (2/3 wires) and KTY84 Total resistance of sensor circuit 750 Ω at 25°C Overheat trigger threshold: 2.9 kΩ ± 0.2 kΩ Overheat reset threshold: 1.575 kΩ ± 75 Ω Threshold for low impedance detection: 50 Ω ±10 Ω Open circuit threshold: 100 kΩ ±10 kΩ <p>Refer to [Thermal monitoring] TPP, page 145 for more information on thermal sensors.</p>
PTC2			
PTC3			
STO	Safety Function STO Input	I	Refer to the Embedded Safety Function manual available on www.se.com
24V			

RUN and STOP Management

Terminal: 2-wire control (2C)

Only one digital input needed for Run and Stop management.

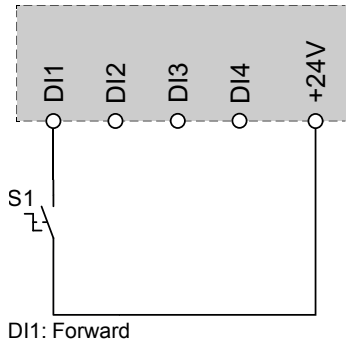

Transition

A change of state (transition) is necessary to initiate operation in order to avoid accidental restarts after a break in the supply mains.

At power-up or on error reset, the motor will not start if D11 is active.

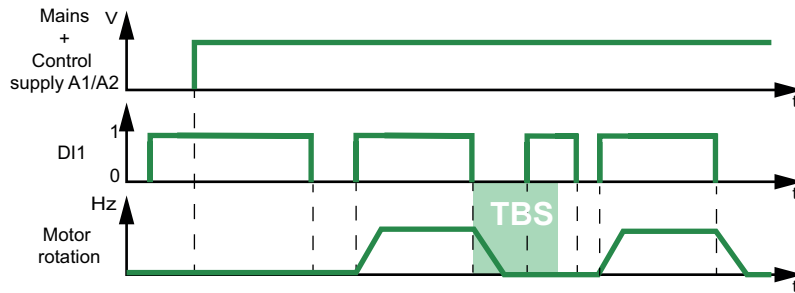

Level

State 0 or 1 is taken into account for run (1) or stop (0).

At power-up or on error reset, the motor will start if DI1 is active.

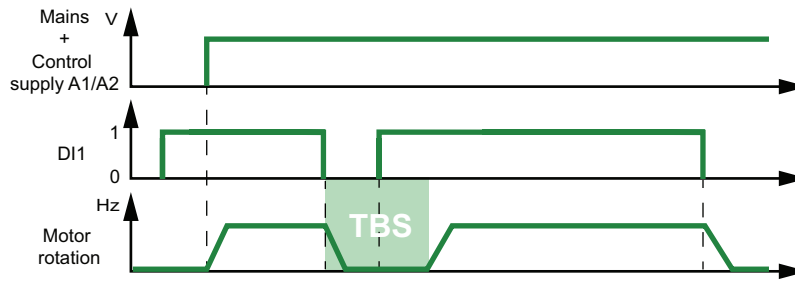

NOTE: TBS stands for **[Wait for Restart]**, linked to certain internal functions. Refer to How to interpret and react to a TBS state, page 328.

NOTE: for the configuration of the soft starter, refer to Set Type of Wire Control, page 121.

Terminal: 3–wire control (3C)

Run and Stop are controlled by 2 different digital inputs.

The Run order is applied at pulse on DI2 only if DI1 is at high level.

The Stop order is applied at low level on the DI1 terminal.

At power-up or on error reset the motor will not start if a Run command is already present.

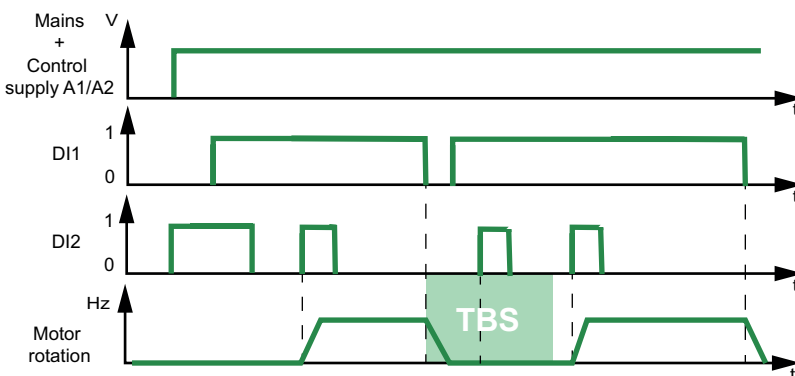
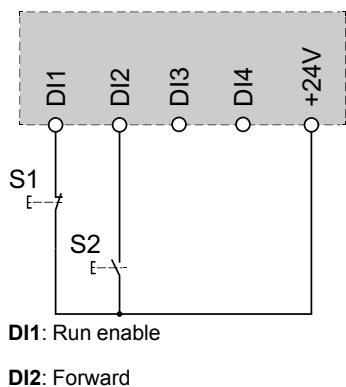

NOTE: TBS stands for [Wait for Restart], linked to certain internal functions. Refer to How to interpret and react to a TBS state, page 328.

NOTE: for the configuration of the soft starter, refer to Set Type of Wire Control, page 121.

Terminal: 2–wire control (Legacy mode) (LC3W)

Run and Stop are controlled by state 1 (closed, active) or 0 (open, inactive), on DI1 and DI2 terminals.

At power-up or on error reset the motor will be powered if a Run command is active.

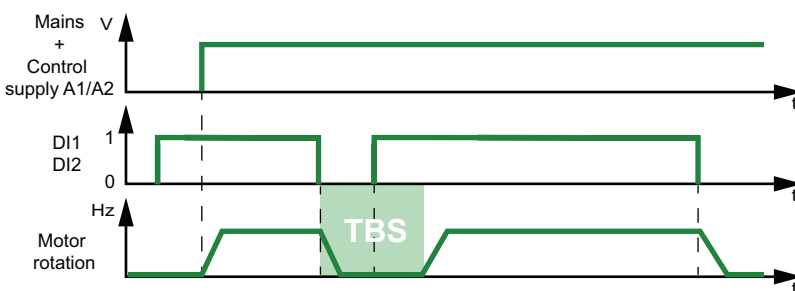
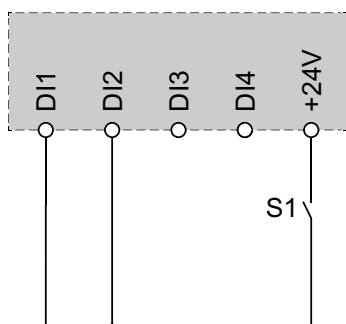

NOTE: TBS stands for [Wait for Restart], linked to certain internal functions. Refer to How to interpret and react to a TBS state, page 328.

NOTE: for the configuration of the soft starter, refer to Set Type of Wire Control, page 121.

Terminal: 3–wire control (Legacy mode) (LC3W)

Run and Stop are controlled by 2 different digital inputs.

The Run order is applied at level on the DI2 terminal and after DI1 terminal is at high level.

The Stop order is applied at low level on the DI1 terminal.

At power-up or on error reset the motor will be powered if a Run command is active.

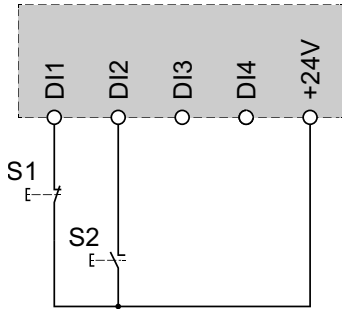

DI1: Run enable

DI2: Forward

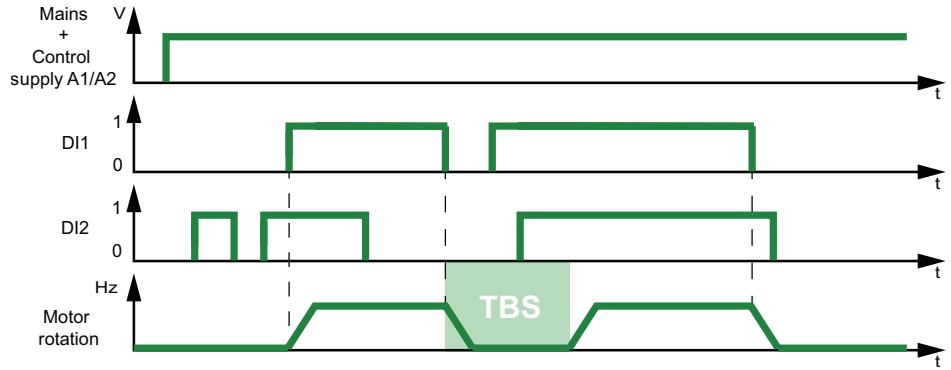

NOTE: TBS stands for **[Wait for Restart]**, linked to certain internal functions. Refer to How to interpret and react to a TBS state, page 328.

NOTE: for the configuration of the soft starter, refer to Set Type of Wire Control, page 121.

Fieldbus and Graphic Display Terminal control

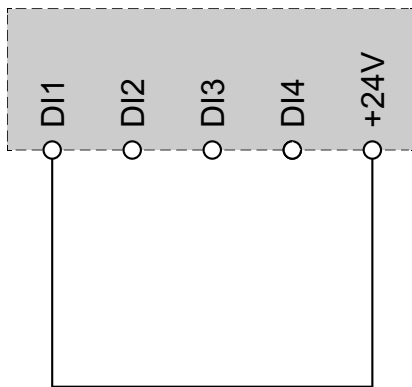

DI1: Run enable

When Fieldbus or Graphic Display Terminal is used to control the soft starter, DI1 must be **handled** in 3C/LC3W and must be connected to the +24V.

For more information, for the remote control, refer to the communication manuals.

Behavior of the soft starter when [Fault Reset Assign] is not assigned

When **[Fault Reset Assign]** is not assigned, **in terminal control** apply a Run order can reset the error of the soft starter. A second run order is necessary to restart the motor. For more information about Fault reset function refer to Error and Warning Handling, page 279.

Relay Contacts Wiring

General

The AC voltage source must be of overvoltage category II (OVC II) according to IEC 60947-4-2 and IEC 60947-1.

If it is not the case, an isolation transformer must be used.

Contactors with AC Coil

If controlled by a relay, a resistor-capacitor (RC) circuit must be connected in parallel to the coil of the contactor as shown on the drawing below.

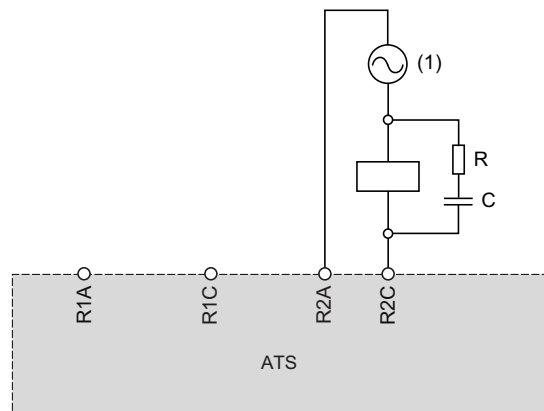

(1) AC 250 Vac maximum.

Schneider Electric AC contactors have a dedicated area on the housing to plug easily the RC device. Refer to the Motor control and protection components catalog MKTED210011EN available on se.com to find the RC device to be associated with the contactor used.

Example: With a 48 Vac source, contactors LC1D09E7 or LC1DT20E7 have to be used with LAD4RCE voltage suppression device.

Other Inductive AC Loads

For other inductive AC loads:

- Use an auxiliary contactor connected on the product to control the load.

Example: with a 48 Vac source, auxiliary contactors CAD32E7 or CAD50E7 with LAD4RCE voltage suppression device.

- When using a third-party inductive AC load, request the supplier to provide information on the voltage suppression device, in order to avoid overvoltage above 375 V during relay opening.

Contactors with DC Coil

If controlled by a relay, a bidirectional transient voltage suppression (TVS) diode, also called transil, must be connected in parallel to the coil of the contactor as shown on the drawing below.

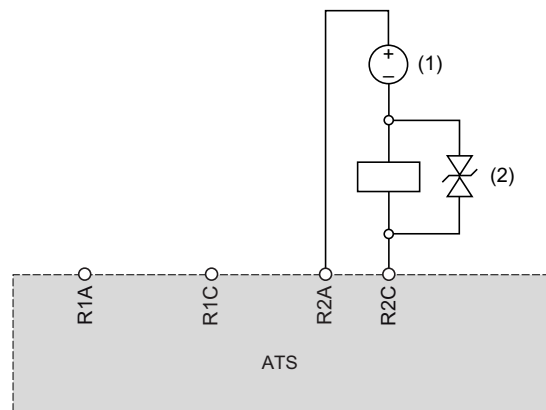

(1) DC 30 Vdc maximum.

(2) TVS diode

Schneider Electric contactors with DC coil include the TVS diode. No additional device is required.

Refer to the Motor control and protection components catalog MKTED210011EN available on se.com for more information.

Other Inductive DC Loads

Other inductive DC loads without embedded TVS diode must use one of the following voltage suppression device:

- A bidirectional TVS device as shown on the drawing above, defined by:
 - TVS break-down voltage greater than 35 Vdc,
 - TVS clamping voltage $V(\text{TVS})$ less than 50 Vdc
 - TVS peak power dissipation greater than load rated current, $I(\text{load}) \times V(\text{TVS})$.

Example: with $I(\text{load}) = 0.9 \text{ A}$ and $V(\text{TVS}) = 50 \text{ Vdc}$, TVS peak power must be greater than 45 W

 - TVS average power dissipation greater than the value calculated by the following $0.5 \times I(\text{load}) \times V(\text{TVS}) \times \text{load time constant} \times \text{number of operation per second}$.

Example: with $I(\text{load}) = 0.9 \text{ A}$ and $V(\text{TVS}) = 50 \text{ Vdc}$, load time constant = 40 ms (load inductance divided by load resistance) and 1 operation every 3 s, the TVS average power dissipation must be greater than $0.5 \times 0.9 \times 50 \times 0.04 \times 0.33 = 0.3 \text{ W}$.
- A fly-back diode as shown in the drawing below.

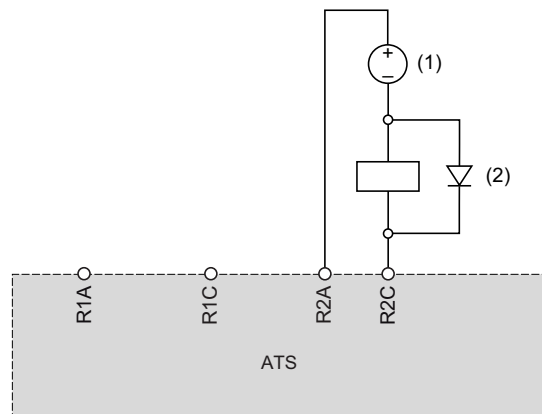

(1) DC 30 Vdc maxi.

(2) Flyback diode

The diode is a polarized device. The fly-back diode must be defined by:

- A reverse voltage greater than 100 Vdc,
- A rated current greater than two times the load rated current,
- A thermal resistance: junction to ambient temperature (in K/W) less than $90 / (1.1 \times I(\text{load}))$ to operate at maximum 60°C (140°F) ambient temperature.

Example: with $I(\text{load}) = 1.5 \text{ A}$, select a 100 V, 3 A rated current diode with a thermal resistance from junction to ambient less than $90 / (1.1 \times 1.5) = 54.5 \text{ K/W}$.

Using a flyback diode, the relay opening time will be longer than with a TVS diode.

NOTE: Use diodes with leads for easy wiring and keep at least 1 cm (0.39 in.) of leads on each side of the case of the diode for a correct cooling.

Software and Tools

NOTE: Make sure that the latest version of the software and of the manuals are used.

SoMove



SoMove is a setup software for PC designed to configure Schneider Electric motor control devices. It incorporates functions for device setup, monitoring, fieldbus management and maintenance via an user-friendly interface.

To download SoMove go to [SoMove FDT](#).

To download the required DTM refer to [ATS490: DTM](#), page 14.

A contextual help for SoMove is available by pressing F1 on the keyboard.

Webserver



The embedded Ethernet provides an integrated Web server which allows several functions like: monitoring, parameter settings, and diagnostics. The Web server can be accessed from standard browsers such as Microsoft Edge, Google Chrome, Firefox, etc.

For more information refer to the [ATS490 EtherNet Manual](#), page 14.

EcoStruxure Control Expert



Control Expert is a setup software for PC designed to configure Schneider Electric Programmable Automation Controllers. It is compatible with Device DTM which allows in its interface to configure, to monitor, to manage and to maintain connected devices.

To download Control Expert and the required DTM, refer to [Related Documents](#), page 14.

Cybersecurity Generalities

What's in This Chapter

Overview	57
Security Policy	60
Product Defense-in-Depth.....	61
ATS490 Security Policy.....	64
Potential Risks and Compensating Controls	67
Data Flow Restriction.....	67
Device Recovery and Reconstitution.....	67

Overview

Title of documentation	Catalog number
Recommended Cybersecurity Best Practices	7EN52-0390 (English)

The objective of Cybersecurity is to help provide increased levels of protection for information and physical assets from theft, corruption, misuse, or accidents while maintaining access for their intended users.

No single Cybersecurity approach is adequate. Schneider Electric recommends a defense-in-depth approach. Conceived by the National Security Agency (NSA), this approach layers the network with security features, appliances, and processes.

The basic components of this approach are:

- Risk assessment
- A security plan built on the results of the risk assessment
- A multi-phase training campaign
- Physical separation of the industrial networks from enterprise networks using a demilitarized zone (DMZ) and the use of firewalls and routing to establish other security zones
- System access control
- Device hardening
- Network monitoring and maintenance

This chapter defines the elements that help you configure a system that is less susceptible to cyber-attacks.

Network administrators, system integrators and personnel that commission, maintain or dispose of a device should:

- Apply and maintain the device’s security capabilities. See for details
- Review assumptions about protected environments. See Protected Environment Assumptions, page 58 sub-chapter for details
- Address potential risks and mitigation strategies. See Product Defense-in-Depth, page 61 for details
- Follow recommendations to optimize cybersecurity

For detailed information on the system defense-in-depth approach, refer to the TVDA: How Can I Reduce Vulnerability to Cyber Attacks (STN V3.0) on se.com.

To submit a Cybersecurity question, report security issues, or get the latest news from Schneider Electric, visit the Schneider Electric website.

▲ WARNING
<p>POTENTIAL COMPROMISE OF SYSTEM AVAILABILITY, INTEGRITY, AND CONFIDENTIALITY</p> <ul style="list-style-type: none"> • Change default password to help prevent unauthorized access to device settings and information. • Disable unused ports/services and default accounts, where possible, to minimize pathways for malicious attacks. • Place networked devices behind multiple layers of cyber defenses (such as firewalls, network segmentation, and network intrusion detection and protection). • Use cybersecurity best practices (for example: least rights, separation of duties) to help prevent unauthorized exposure, loss or modification of data and logs, interruption of services, or unintended operation. <p>Failure to follow these instructions can result in death, serious injury, or equipment damage.</p>

Protected Environment Assumptions

Machines, controllers, and related equipment are usually integrated into networks. Unauthorized persons and malware may gain access to the machine as well as to other devices on the network/fieldbus of the machine and connected networks via insufficiently secure access to software and networks.

⚠ WARNING

UNAUTHORIZED ACCESS TO THE MACHINE VIA SOFTWARE AND NETWORKS

- In your hazard and risk analysis, consider all hazards that result from access to and operation on the network/fieldbus and develop an appropriate cybersecurity concept.
- Verify that the hardware infrastructure and the software infrastructure into which the machine is integrated as well as all organizational measures and rules covering access to this infrastructure consider the results of the hazard and risk analysis and are implemented according to best practices and standards covering IT security and cybersecurity (such as: ISO/IEC 27000 series, Common Criteria for Information Technology Security Evaluation, ISO/IEC 15408, IEC 62351, ISA/IEC 62443, NIST Cybersecurity Framework, Information Security Forum - Standard of Good Practice for Information Security, SE recommended Cybersecurity Best Practices*).
- Verify the effectiveness of your IT security and cybersecurity systems using appropriate, proven methods.

Failure to follow these instructions can result in death, serious injury, or equipment damage.

(*) : SE Recommended Cybersecurity Best Practices can be downloaded on SE.com.

Additionally, use a layered network approach with multiple security and defense controls in your IT and control system to minimize data protection gaps, reduce single-points of failure and create a strong cybersecurity posture. The more layers of security in your network, the harder it is to breach defenses, take digital assets or cause disruption.

Control System - Cybersecurity policy

- Cybersecurity governance – available and up-to-date guidance on governing the use of information and technology assets in your company that is matching with a dedicated risk analysis about the control system
- The access control policy defined in the cybersecurity governance is strictly applied. In particular, it guarantees the authenticity of privileged operations. For example operations that can alter the critical assets.
- The instructions and procedures should structure the roles and responsibilities in terms of security within the organization; in other words, who is authorized to perform what and when. These should be known by the users.
- Define information security continuous monitoring (ISCM) to maintain the awareness of information security, vulnerabilities and threats to your organization.
- Perform patch management by applying security patches from vendor to ensure stability and completeness.

Physical perimeter security

- Set up the devices in an enclosed area with physical access control to prevent unauthorized access to the device, with dedicated monitoring

Physical network segmentation

Independence from non-control system networks – the control system provides network services to control system networks, critical or non-critical, without a connection to non-control system networks

- Physically segment control system networks from non-control system network
- Physically segment critical control system networks from non-critical control system networks

Logical isolation of critical networks

The control system provides the capability to logically and physically isolate critical control system networks from non-critical control system networks. For example, using VLANs.

Zone boundary protection – the control system provides the capability to:

- Manage connections through managed interfaces consisting of appropriate boundary protection devices, such as: proxies, gateways, routers, firewalls, and encrypted tunnels
- Use an effective architecture, for example, firewalls protecting application gateways residing in a DMZ
- Control system boundary protections at any designated alternate processing sites should provide the same levels of protection as that of the primary site, for example, data centers

No public internet connectivity – access from the control system to the internet is not recommended

Information disclosure prevention

- Encrypt protocol transmissions over all external connections using an encrypted tunnel, TLS wrapper or a similar solution
- Reduce access to control system information by distributing permissions according to predefined access control with least privilege practices

Control against malware

- Detection, prevention, and recovery controls to help protect against malware are implemented and combined with appropriate user awareness
- Any computer in use on the control system either on premise or temporarily connected, should have an updated anti-virus, anti-malware, anti-ransomware application activated during the use

Resource & control system availability

- Ensure continuity of service – ability to break the connections between different network segments or use duplicate devices in response to an incident. RSTP, redundancy of controllers or network devices like switches or similar solution.
- Manage communication loads – the control system provides the capability to manage communication loads to mitigate the effects of information flooding types of DoS (Denial of Service) events
- Manage the retention cycles of data and programs with the retention periods determined as appropriate. FDR can be used for instance.

Security Policy

⚠ WARNING

ACCESSIBILITY LOSS

- Setup a security policy to your device and backup the device image with security administrator user account.
- Define and regularly review the password policy.
- Periodic change of the passwords, Schneider Electric recommends a modification of the password each 90 days.

Failure to follow these instructions can result in death, serious injury, or equipment damage.

Cybersecurity helps to provide:

- Confidentiality (to help prevent unauthorized access)
- Integrity (to help prevent unauthorized modification)
- Availability/authentication (preventing the denial of service and assuring authorized access)
- Non-repudiation (preventing the denial of an action that took place)
- Traceability/detection (logging and monitoring)

Norm IEC 62443 is the worldwide standard for security of industrial control system (ICS) networks.

The Ativar Soft Starter ATS490 holds certification for IEC 62443-4-1 for Secure Development Lifecycle and IEC 62443-4-2 Security Level 1 (SL1) for Security features provided

Ativar Soft Starter ATS490 security features prevent the unauthorized disclosure of information via eavesdropping or casual exposure.

All the security rules implemented in the ATS490 are in complement of the points mentioned above.

The device does not have the capability to transmit data encrypted using the following protocols: HTTP, Modbus slave over serial, Modbus slave over Ethernet, EtherNet/IP, SNMP, SNTIP. If other users gained access to your network, transmitted information can be disclosed or subject to tampering.

⚠ WARNING

CYBERSECURITY HAZARD

- For transmitting data over an internal network, physically or logically segment the network, the access to the internal network needs to be restricted by using standard controls such as firewalls.
- For transmitting data over an external network, encrypt protocol transmissions over all external connections using an encrypted tunnel, TLS wrapper or a similar solution.

Failure to follow these instructions can result in death, serious injury, or equipment damage.

Any computer using SoMove, DTM, Webserver or EcoStruxure Control Expert should have an updated anti-virus, anti-malware, anti-ransomware application activated during the use.

The ATS490 has the capability to export its settings and files manually or automatically. It is recommended to archive any settings and files (device backup images, device configuration, device security policies) in a secure area.

Product Defense-in-Depth

Altivar Soft Starter ATS490 offers the following security features:

Threats	Desired security property on Embedded Device	ATS490 security features
Information disclosure	Confidentiality	Password encrypted in a non-reversible way
		User access control
Tampering	Device integrity	Cryptographic signature of firmware package
		Secure root of trust
Denial of Service	Availability	Device backup/restore
		Security export/import
Spoofing/Elevation of privilege	User Authentication / Authorization	Strong password and user account policy
		Access control local display terminal
		Access control commissioning tools Modbus Serial
		Access control commissioning tools Modbus TCP
		Access control over WebServer
Elevation of privilege	Authorization	Port hardening
		User roles & rights
Repudiation	Non-repudiability	Secure event logging

Confidentiality

Information confidentiality capacity prevents unauthorized access to the device and information disclosure.

- The user access control helps on managing users that are authorized to access the device. Protect user credential at usage.
- The user’s passwords are encrypted in non-reversible way at rest

Device Integrity Protection

The device integrity protection prevents unauthorized modification of the device with tampered or spoofed information.

This security capability helps protect the authenticity and integrity of the firmware running on the ATS490 and facilitates protected file transfer: digitally signed firmware is used to help protect the authenticity of the firmware running on the ATS490 and only allows firmware generated and signed by Schneider Electric.

- Cryptographic signature of the firmware package executed at the firmware update
- Secure root of trust ensures integrity and authenticity of the device firmware at each power-up

Availability

The control system backup is essential for recovery from a control system failure and/or misconfiguration and participate on preventing denial of service. It also helps ensure global availability of the device by reducing operator overhead on security application/deployment.

These security capabilities help manage control system backup with the device:

- Independent security policy import/export for local secure backup and security policy sharing with other devices.
- Complete device backup/restore available on local HMI, DTM.

Authentication and Authorization

The user authentication helps prevent the repudiation issue by managing user identification and prevents information disclosure and device integrity issues by unauthorized users.

These security capabilities help enforce authorizations assigned to users, segregation of duties and least rights:

- User authentication is used to identify and authenticate software processes and devices managing accounts
- Device Password policy and password strength configurable using SoMove, DTM or EcoStruxure Control Expert and DTM
- Authorization managed according to channels
- User account lockouts configurable with number of unsuccessful login attempts

In line with user authentication and authorization, the device has access control cryptographic features to check user credential before access is granted to the system.

In the ATS490, the control of accessibility to the settings, parameters, configuration, and logging database is done with a user authentication after "Log in", with a name and password.

The ATS490 controls the access through :

- SoMove DTM (Serial and Ethernet connection)
- EcoStruxure Control Expert

Port Hardening

The communication ports of the ATS490 can be disabled. Logical ports can be enabled/disabled. Port hardening configuration can be set from SoMove DTM with the ADMIN or SecAdmin right.

Security Event Logging

The security event logging prevents the repudiation issues by ensuring traceability and detection of any service executed and affecting the security policy of the device.

These security capabilities support the analysis of security events, help protect the device from unauthorized alteration and records configuration changes and user account events:

- Human-readable reports for device security settings
- Audit event logs to identify:
 - The ATS490 security configuration modification
 - The device users' activity (e.g. login, logout)
 - The device firmware updates
 - Audit storage capacity of 500 security event logs
 - Timestamps, including date and time, match ATS490 clock

ATS490 Security Policy

To facilitate cybersecurity first configurations, the ATS490 offers 2 security policies with preset ATS490 security features. This operation applies default values adapted to the security level targeted by the system of which the device is part.

Selection of these 2 security policies can be done upon first power up of the device, both with the display terminal (Refer to *First Power-Up*, page 108 for more information) and Commissioning tool (DTM).

Security Policy “Minimum”

This profile offers a minimum of cybersecurity features. The user access control (login & password check at connection) are disabled on SoMove, EcoStruxure Control Expert, and WebServer.

Those connections remain unsecured and open for potential elevation of privilege. This profile is to be used for installation where authentication & authorization constraints are covered by access control mitigation external to the device.

When Minimum policy is selected, each user accessing the device is considered to have limited privileges.

Security Policy “Advanced”

This profile presets the device security by enabling security features. The user access control is enabled for SoMove, EcoStruxure Control Expert, and WebServer.

When activating the “Advanced” security policy, the user is identified as ADMIN and is requested to create a password unique to the device.

If configured by Graphic Display Terminal, a default password is displayed. It is mandatory to change it on the first connection.

To apply the “Advanced” security policy, perform the procedure described in the step by step, page 109.

Further configuration can be done using Commissioning tool (DTM).

Refer to the following cybersecurity features summary per security policy:

ATS490 security feature	Open for configuration (activation or settings)	Preset security policy	
		Minimum	Advanced
Password encrypted in a non-reversible way	-	-	✓
User access control	-	-	✓
Cryptographic signature of firmware package	-	✓	✓
Secure root of trust	-	✓	✓
Device backup	ADMIN or SecAdmin only	-	✓
Device restore	ADMIN or SecAdmin only	✓	✓
Security Save	ADMIN or SecAdmin only	-	✓
Security Restore	ADMIN or SecAdmin only	✓	✓
User management	ADMIN or SecAdmin only	-	✓
Strong password/pin code policy	ADMIN or SecAdmin only	-	✓
Brute force and session timeout	ADMIN or SecAdmin only	-	✓
System use notification	ADMIN or SecAdmin only	-	✓
Access control: <ul style="list-style-type: none"> • Commissioning tools (Modbus Serial and TCP) • Webserver • Display terminal 	For all users	✓	✓
Secure events recorded	ADMIN or SecAdmin only	✓	✓
Port hardening	ADMIN or SecAdmin only	-	✓

Import / Export Security Policy

The device security settings can be exported from a device to be archived and/or applied in the same or another device. The result of a security policy export consists in the creation of a security policy file. This file is identified with the extension .secp.

The following table describes the security settings included in the security policy export:

Security settings	Included in import / export operation
User access control settings	✓
Password & Pin code policy, including session lock and user account lockout configuration	✓
User database, including username, password, pin codes and roles	✓
Password history	✓
Ports and Service management, Device topology, Brute force mitigation and session timeout, system use notification	✓
Device default password	For security reasons, the default password is unique to each device and cannot be exported.
Security events	The security events base is private property of a device and cannot be applied to another device.

NOTE: When a security configuration file is loaded, please restart the device.

Potential Risks and Compensating Controls

Address potential risks using these compensating controls:

Area	Issue	Risk	Compensating controls
User accounts.	Default account settings are often the source of unauthorized access by malicious users.	If you do not change default password or disable the user access control, unauthorized access can occur.	Ensure User access control is enabled on all the communication ports and change the default passwords to help reduce unauthorized access to your device.
Secure protocols.	The device does not have the capability to transmit data encrypted using these protocols: <ul style="list-style-type: none"> • Modbus Serial • Modbus TCP • EtherNet/IP • SNMP • HTTP 	If a malicious user gained access to your network, they could intercept communication.	For transmitting data over internal network, physically or logically segment your network. For transmitting data over external network, encrypt protocol transmissions over all external connections using an encrypted tunnel, TLS wrapper or a similar solution. See Protected Environment Assumptions , page 58.
Security banners	The local graphic display terminal cannot display the security banner.	The users connecting to the ATS490 will not be able to be warned about potential security notifications.	If such security notification shall be shared with users, then a local message shall be added close to the ATS490. Example : A sticker on the electrical cabinet or the electrical room can inform user about specific security considerations

Data Flow Restriction

A firewall device is required to secure the access to the device and limit the data flow.

For detailed information, refer to the TVDA: How Can I Reduce Vulnerability to Cyber Attacks (STN V3.0).

Device Recovery and Reconstitution

Control system backup – available and up-to-date backups for recovery from a control system failure.
Available and up-to-date firmware package for recovery from a system disaster. The customer stores the current used firmware version package or the latest up-to-date firmware package available on **se.com**.

Both Control System backup and firmware package, shall be considered as assets with dedicated risk analysis according to your local Cybersecurity policy. Make sure the access and use of these files are protected by appropriate security controls to ensure the trust, availability and effectiveness of the device’s disaster recovery plan.

NOTE:

- Complete device recovery can be performed by applying the firmware update package and the device backup image previously stored by the customer.
- In case of a firmware recovery on the product is not possible, please contact your local Schneider Electric representative.

Inspect, Store and Handle the Product

What's in This Part

Inspecting the Product	69
Storage and Shipping	70
Weight And Lifting Lugs Availability.....	72
Unpacking and Hoisting on Pallet	73

Inspecting the Product

Unpack the soft starter and verify that it is not damaged.

Damaged products or accessories may cause electric shock or unanticipated equipment operation.

⚡ ⚠ DANGER
ELECTRIC SHOCK OR UNANTICIPATED EQUIPMENT OPERATION
Do not use damaged products or accessories.
Failure to follow these instructions will result in death or serious injury.

Contact your local Schneider Electric sales office if you detect any damage whatsoever.

Step	Action
1	Verify that the reference number printed on the nameplate corresponds to the purchase order.
2	Before performing any installation work inspect the product for visible damage.

Store the product in its original packaging if not installed immediately after inspection.

Storage and Shipping



NOTICE
<p>INCORRECT STORAGE</p> <p>Do not crush the packaging during transport and storage.</p> <p>Failure to follow these instructions can result in equipment damage.</p>

Refer to the stacking instructions on the packaging. The environment during transportation and storage must be dry and free from dust.

	IEC Standard	Transport and Storage
Ambient temperature		-25...70° C (-13...158 °F)
Relative humidity	IEC 60068–2–3	Maximum 93 % without condensation or dripping water
Vibration resistance	IEC 60068–2–6	<ul style="list-style-type: none"> • 3.5 mm peak to peak from 2 to 9Hz • 10 m/s² from 9 to 200 Hz
Shock resistance	IEC 60068–2–27	150 m/s ² (15 g) during 11 ms

For more information refer to Major Characteristics, page 20.

If the soft starter must be shipped to another location, use the original shipping material.

⚠ WARNING
<p>INCORRECT HANDLING</p> <ul style="list-style-type: none"> • Lifting and handling must be performed by qualified personnel in accordance with the requirements of the site and in compliance with all pertinent regulations. • Verify that there are no persons or obstructions in the area of operation of the lifting and handling equipment. • Use lifting and handling equipment appropriate for the load and take all necessary measures to avoid swinging, inclination, toppling and any other potentially hazardous conditions. • Follow all handling instructions provided in this manual and in all associated product documentation. • Take all measures required to avoid damage to the product and other hazards when handling or opening the packaging. • Handle and store the product in its original packaging. • Do not handle and store the product if the packaging is damaged or appears to be damaged. <p>Failure to follow these instructions can result in death, serious injury, or equipment damage.</p>

To help protect the product before installation, handle and store it in its packaging. Ensure that the specified ambient conditions are followed.

▲ WARNING**SHARP EDGES**

Use all necessary personal protective equipment (PPE) such as gloves when performing any type of work whatsoever on or with this product.

Failure to follow these instructions can result in death, serious injury, or equipment damage.

Weight And Lifting Lugs Availability

The weights, lifting lugs availability and packaging types are provided in the following table:

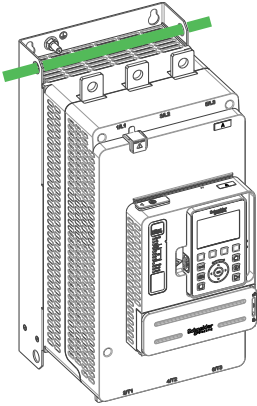

References	Weight kg (lbs)	Lifting lugs	Packaging
ATS490D17Y, D22Y	4 (8.2)	No	Cardboard box
ATS490D32Y...D47Y	6 (13.2)	No	Cardboard box
ATS490D62Y...C11Y	7 (15.4)	No	Cardboard box
ATS490C14Y...C17Y	10 (22)	No	Cardboard box
ATS490C21Y...C41Y	19 (41.9)	Yes	Pallet
ATS490C48Y...C66Y	28 (61.7)	Yes	Pallet
ATS490C79Y...M12Y	65 (143.3)	Yes	Pallet

Unpacking and Hoisting on Pallet

For ATS490C21Y to ATS490M12Y, consider this additional safety message:

▲ WARNING

TIPPING

- Take into account the high center of gravity when handling the equipment.
- Only transport the equipment on the pallet using a suitable forklift.
- Do not remove the straps and the screws on the pallet before the equipment has been transported to the final installation position.

Failure to follow these instructions can result in death, serious injury, or equipment damage.

▲ WARNING

SHARP EDGES

Use all necessary personal protective equipment (PPE) such as gloves when performing any type of work whatsoever on or with this product.

Failure to follow these instructions can result in death, serious injury, or equipment damage.

▲ WARNING

TOPPLING, SWINGING, OR FALLING EQUIPMENT

- Take all measures necessary to keep the equipment from swinging, toppling and falling.
- Follow the instructions provided to remove the equipment from the packaging and to mount it at its final position.

Failure to follow these instructions can result in death, serious injury, or equipment damage.

See the procedure for hoisting the product references from ATS490C21Y to ATS490M12Y:

Step	Action
1	Lift the soft starter by means of a hoist by using the handling lugs of the soft starter to fasten the lifting equipment. The lifting bar is not supplied.
2	Keep the soft starter suspended by means of appropriate equipment until it is securely fastened in the final installation position.
3	Move the soft starter to the final installation or on the back of the enclosure.

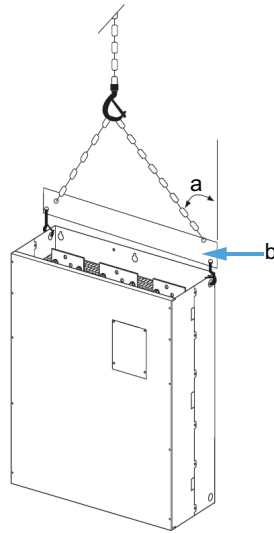

- a: 45° maximum
- b: Lifting bar

Installation

What's in This Part

Electronic product data sheet	76
Mounting a graphic display terminal VW3A1111 on the door of the enclosure.....	77
Inserting the Fieldbus Modules	78
Wiring.....	79
Checking Installation	91

Electronic product data sheet

Scan the QR code in front of the soft starter to get the product data sheet.

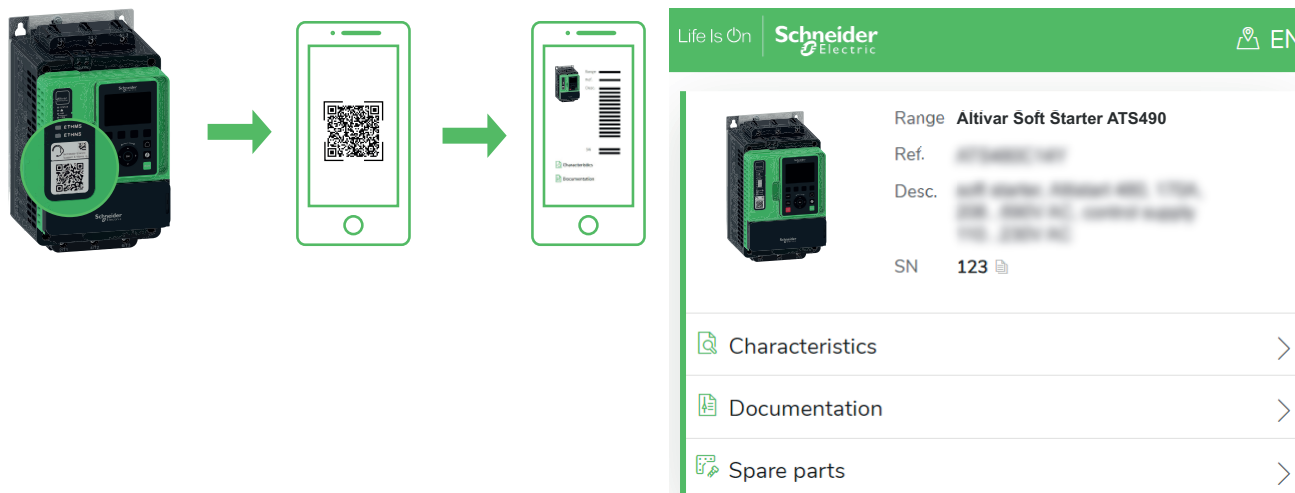

The diagram illustrates the process of scanning a QR code on a soft starter to access its product data sheet. It shows the physical soft starter, a smartphone scanning the QR code, and the resulting product data sheet interface.

The product data sheet interface displays the following information:

- Range: **Altivar Soft Starter ATS490**
- Ref. [blurred]
- Desc. [blurred]
- SN: **123**

The interface also provides access to the following sections:

- Characteristics
- Documentation
- Spare parts

Scanning the QR Code gives you access to :



- Product ID Card : Product range, Reference, short description and a Serial Number (Use the serial number to retrieve the product's manufacturing date).
About the Serial Number, refer to Manufacturing Date, page 325.
- The product characteristics : Main characteristics, environment, packing units, sustainability...
- Documentation : Technical Guidance at Glance (Presentation, Dimensions, Mounting, Wiring, Commissioning...) and Product Documentation (User guide, Instructions sheets, Certificates, How To videos...)
- Spare parts for your product

Mounting a graphic display terminal VW3A1111 on the door of the enclosure

The ATS490 is delivered with the VW3A1111 Graphic Display Terminal.

Door mounting kit is available as option to mount the display terminal on the door of the enclosure.

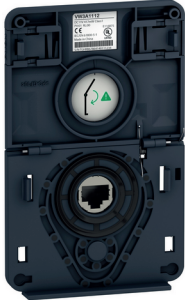
Refer to the following table for more information.

Door Mounting Kit protection degree	Display terminal	Door mounting kit
IP65	<p>VW3A1111 Graphic Display Terminal</p> <p>Delivered with the soft starter</p> 	<p>VW3A1112 door mounting kit.</p> <p>Available as option</p>  <p>Refer to the instruction sheet EAV76406.</p>
<p>Select one of the following RJ45 cables to connect the door mounting kit to the soft starter:</p> <ul style="list-style-type: none"> • 1 meter: VW3A1104R10 • 3 meters: VW3A1104R30 • 5 meters: VW3A1104R50 • 10 meters: VW3A1104R100 <p>Not included with the door mounting kit</p>		

Inserting the Fieldbus Modules

The table provides the procedure for insertion of the fieldbus module in the soft starter:

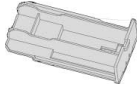
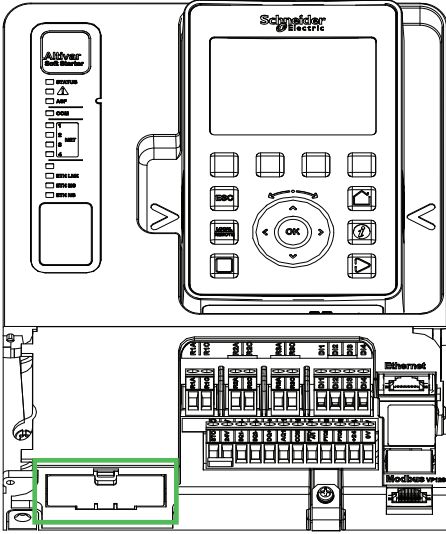
Step	Action
1	Ensure that the power is off.
2	Locate the fieldbus module slot on the bottom of the control part.
3	<p>Remove the false module () with the help of a screwdriver.</p>  <p>Fieldbus Module Slot</p>
4	Insert the module.
5	Check that the module is correctly inserted and locked mechanically in the soft starter.

Refer to Option Modules Instruction Sheet S1A45591 for more information.

Wiring

What's in This Chapter

Wiring the Power Part for ATS490D17Y...ATS490C11Y 82
 Wiring the Power Part for ATS490C14Y...ATS490M12Y 84
 Wiring the Control Terminals 87

General instructions

⚡⚠ DANGER

HAZARD OF ELECTRIC SHOCK, EXPLOSION OR ARC FLASH

Read and understand the instructions in **Product Related Information** chapter before performing any procedure in this chapter.

Failure to follow these instructions will result in death or serious injury.

⚡⚠ DANGER

HAZARD OF FIRE OR ELECTRIC SHOCK

- Wire cross sections and tightening torques must comply with the specifications provided in this document.
- If you use flexible multi-wire cables for a connection with a voltage higher than 25 Vac, you must use ring type cable lugs or wire ferrules, depending on the wire gauge and the specified stripping length of the cable.

Failure to follow these instructions will result in death or serious injury.

The product has a leakage current greater than 3.5 mA. If the protective ground connection is interrupted, a hazardous touch current may flow if the product is touched.

⚡⚠ DANGER

ELECTRIC SHOCK CAUSED BY HIGH LEAKAGE CURRENT

Verify compliance with all local and national electrical code requirements as well as all other applicable regulations with respect to grounding of the entire installation.

Failure to follow these instructions will result in death or serious injury.

⚡⚠ DANGER

INSUFFICIENT PROTECTION AGAINST SHORT CIRCUIT AND OVERCURRENTS CAN CAUSE FIRE OR EXPLOSION

- Use properly rated Short Circuit Protection Devices (SCPD).
- Use the fuses/circuit breakers specified.

Failure to follow these instructions will result in death or serious injury.

⚡⚠ DANGER**HAZARD OF ELECTRIC SHOCK, EXPLOSION, OR FIRE**

The opening of the branch-circuit protective device is able to be an indication that a fault current has been interrupted.

- Current-carrying parts and other components of the controller should be examined and replaced if damaged.
- If burnout of the current element of an overload relay occurs, the complete overload relay must be replaced.

Failure to follow these instructions will result in death or serious injury.

Product may perform unexpected movements because of incorrect wiring, incorrect settings, incorrect data or other errors.

⚠ WARNING**UNANTICIPATED EQUIPMENT OPERATION**

- Carefully install the wiring in accordance with the EMC requirements.
- Do not operate the product with unknown or unsuitable settings or data.
- Perform a comprehensive commissioning test.

Failure to follow these instructions can result in death, serious injury, or equipment damage.

Refer to the following instructions to wire the soft starter:

- Do not route signal cables next to power cables.
- Cables connected to the motor must have the maximum possible separation from all other power cables. Do not run them in the same conduit. This separation reduces the possibility of coupling electrical noise between circuits.
- Voltage and frequency specifications for the supply mains must match the soft starter configuration.
- A disconnection switch must be installed between the supply mains and the soft starter.
- Power factor correction capacitors should not be connected to a motor controlled by a soft starter. If power factor correction is required, the capacitors must be located on the mains of the soft starter. A separate contactor should be used to switch the capacitors off when the motor is off, or during acceleration and deceleration. Use the relay R2 or a DQ (with an external device) assign to **[End Of Start]** to switch the contactors.
- The soft starter must be grounded to conform to the regulations concerning leakage currents. If the installation involves several soft starters on the same supply mains, each soft starter must be grounded separately.

Equipment Grounding

⚡ ⚠ DANGER

ELECTRIC SHOCK CAUSED BY INSUFFICIENT GROUNDING

- Verify compliance with all local and national electrical code requirements as well as all other applicable regulations with respect to grounding of the entire device.
- Ground the device before applying voltage.
- The cross section of the protective ground conductor must comply with the applicable standards.
- Do not use conduits as protective ground conductors; use a protective ground conductor inside the conduit.
- Do not consider cable shields to be protective ground conductors.

Failure to follow these instructions will result in death or serious injury.

Connection Instructions

The product has a leakage current greater than 3.5 mA. If the protective ground connection is interrupted, a hazardous touch current may flow if the product is touched.

⚡ ⚠ DANGER

ELECTRIC SHOCK CAUSED BY HIGH LEAKAGE CURRENT

Verify compliance with all local and national electrical code requirements as well as all other applicable regulations with respect to grounding of the entire installation.

Failure to follow these instructions will result in death or serious injury.

- Ensure that the resistance to Ground is 1 Ohm or less.
- When grounding several soft starters, you must connect each one directly, as shown in the above figure.
- Do not loop Ground cables or connect them in series.

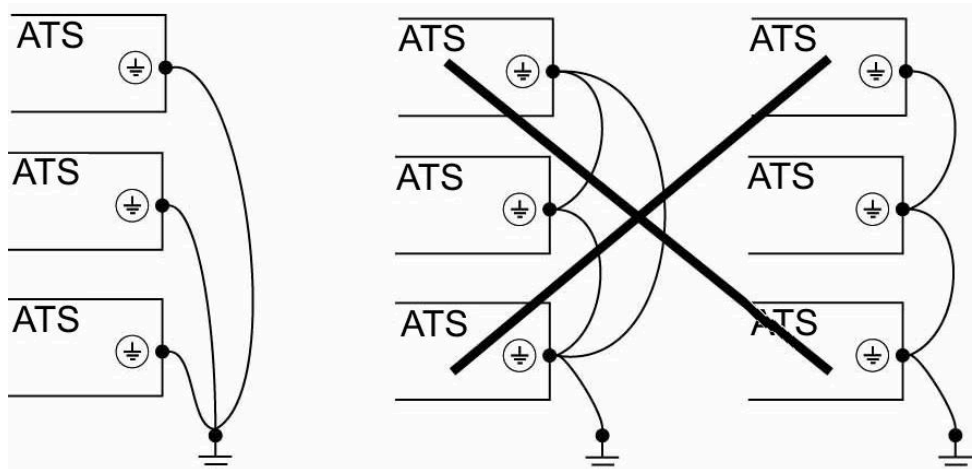

Wiring the Power Part for ATS490D17Y...ATS490C11Y

Mains side

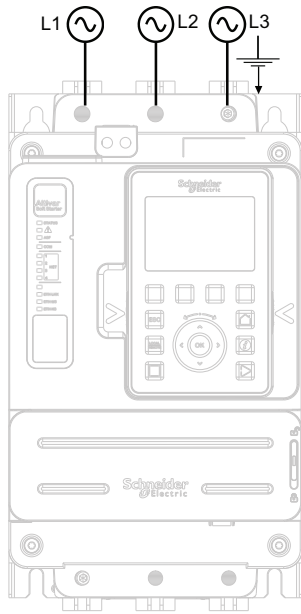

Motor side (bottom)

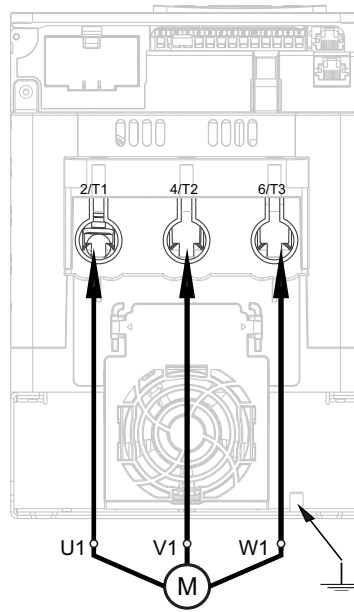

Use class C cables for the power connections.

- 1/L1, 3/L2, 5/L3: Mains supply inputs
- 2/T1, 4/T2, 6/T3: Outputs to motor
- \perp : Ground connection

Simple diagrams for the power connections are available at Connection In line and Inside Delta, page 22.

Complete application diagrams including power and control connections are available at Application Diagrams, page 37.

Ground Connection Characteristics

References	Section	Tightening torque	Screw size Down force size
	mm ² (AWG)	N.m (lbf.in)	
ATS490D17Y...D47Y	10 (10)	5 (44)	H10
ATS490D62Y...C11Y	16 (6)	9 (80)	

Recommended Wire cross section

References	Power connectors 1/L1, 3/L2, 5/L3, 2/T1, 4/T2, 6/T3	
	Recommended Wire cross section (a)	
	mm ² (AWG)	
	For current level at 0.4 of the soft starter rating: (b)	For current level at 1 of the soft starter rating:
ATS490D17Y	2.5 (12)	2.5 (12)
ATS490D22Y	2.5 (12)	4 (10)
ATS490D32Y	2.5 (12)	6 (8)
ATS490D38Y	2.5 (12)	10 (8)
ATS490D47Y	2.5 (12)	10 (8)
ATS490D62Y	4 (10)	16 (6)
ATS490D75Y	6 (10)	25 (4)
ATS490D88Y	10 (8)	25 (3)
ATS490C11Y	10 (8)	35 (1)

- **(a)** The cross section cable values are given for one cable per cages. The good behavior of the ATS490 is not assured with more than one cable per cages.
- **(b)** The cable gauge affects the IP protection degree. IP20 protection degree requires end caps and a minimum cable gauge of:
 - 16 mm² (6 AWG) for product references ATS490D62Y and ATS490D75Y
 - 25 mm² (4 AWG) for product references ATS490D88Y and ATS490C11Y

If this condition is not met, the IP protection degree is IP10.

Mechanical capacity of terminal blocks, stripping length, tightening torque

References	Power connectors 1/L1, 3/L2, 5/L3, 2/T1, 4/T2, 6/T3				
	Mechanical capacity of terminal blocks		Stripping length		Tightening torque
	mm ² (AWG)		mm (in)		
	Minimum	Maximum	Minimum	Maximum	N.m (lbf.in)
ATS490D17Y	2.5 (10)	10 (6)	16 (0.6)	18 (0.7)	5 (44)
ATS490D22Y					
ATS490D32Y					
ATS490D38Y					
ATS490D47Y	10 (6)	25 (3)	16 (0.6)	18 (0.7)	9 (80)
ATS490D62Y					
ATS490D75Y					
ATS490D88Y	25 (3)	50 (1)	16 (0.6)	18 (0.7)	9 (80)
ATS490C11Y					

Wiring the Power Part for ATS490C14Y...ATS490M12Y

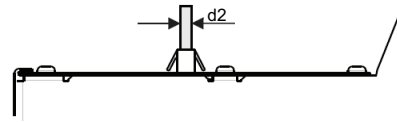
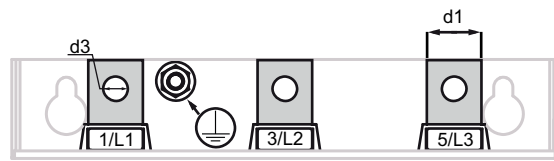
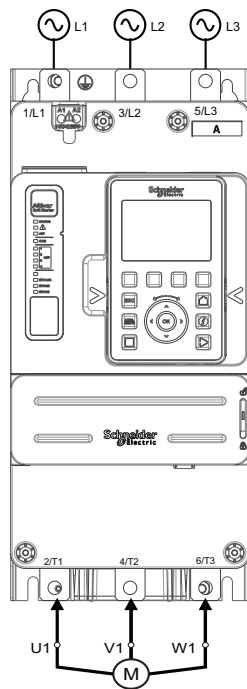

- 1/L1, 3/L2, 5/L3: Mains supply inputs
- 2/T1, 4/T2, 6/T3: Outputs to motor
- \perp : Ground connection

Simple diagrams for the power connections are available at [Connection In line and Inside Delta](#), page 22.

Complete application diagrams including power and control connections are available at [Application Diagrams](#), page 37.

Ground Connection Characteristics

References	Section	Tightening torque	Screw size
	mm ² (AWG)	N·m (lbf.in)	Down force size
ATS490C14Y, C17Y	35 (4)	5 (44)	H13
ATS490C21Y, C25Y	150 (2)	12 (106)	H13
ATS490C32Y, C41Y	150 (2)	12 (106)	H16
ATS490C48Y...C66Y	240 (0)	24 (212)	H16
ATS490C79Y...M12Y	300 (3/0)	24 (212)	H16

Recommended wire cross section

References	Power connectors 1/L1, 3/L2, 5/L3, 2/T1, 4/T2, 6/T3	
	Section mm ² (AWG)	
	For current level at 0.4 of the soft starter rating:	For current level at 1 of the soft starter rating:
ATS490C14Y	16 (6)	50 (2/0)
ATS490C17Y	25 (4)	70 (3/0)
ATS490C21Y	25 (4)	95 (4/0)
ATS490C25Y	35 (3)	120 (350 kcmil)
ATS490C32Y	50 (1)	185 (500 kcmil)
ATS490C41Y	70 (2/0)	240 (2x250 kcmil)
ATS490C48Y	95 (3/0)	2x150 (2x350 kcmil)
ATS490C59Y	120 (250 kcmil)	2x185 (2x350 kcmil)
ATS490C66Y	150 (300 kcmil)	2x185 (3x300 kcmil)
ATS490C79Y	185 (400 kcmil)	2x240 (Cu bar 2x(2x0.25"))
ATS490M10Y	2x150 (2x250 kcmil)	Cu bar 2x(60x5mm) (2.5x0.25")
ATS490M12Y	2x150 (2x250kcmil)	Cu bar 2x(80x5mm) (3x0.25")

Bar characteristics and tightening torque

References	Power connectors 1/L1, 3/L2, 5/L3, 2/T1, 4/T2, 6/T3				
	Bar			Tightening torque	
	d1 mm (in)	d2 mm (in)	d3 mm (in)	N.m (lbf.in)	
ATS490C14Y	20 (0.8)	3 (0.1)	13.5 (0.6)	12 (106)	
ATS490C17Y					
ATS490C21Y	30 (1.1)	5 (0.2)		14 (0.5)	44 (389)
ATS490C25Y					
ATS490C32Y					
ATS490C41Y					
ATS490C48Y	40 (1.6)	5 (0.2)	14 (0.5)		44 (389)
ATS490C59Y					
ATS490C66Y	60 (2.3)	5 (0.2)		14 (0.5)	44 (389)
ATS490C79Y					
ATS490M10Y					
ATS490M12Y	60 (2.3)	5 (0.2)			14 (0.5)
ATS490M12Y					

Special case of Aluminum cables

The use of aluminum field wiring cables is allowed on ATS490 from ATS490C14Y to ATS490M12Y with limitation.

In case of usage of terminal protection kits, the cross section of aluminum cable may be incompatible with the protection kit capacity and can cause equipment damage or impossible mounting.

⚠ DANGER

HAZARD OF FIRE OR/AND TERMINALS OVERHEATING

- The plating of aluminum wire termination must only be compatible with the tin plated copper terminals of the product as regards to galvanic corrosion.
- The sizing of the aluminum wires must be made in accordance with the information below⁽¹⁾.
- The sizing of aluminum wire terminations must not exceed the terminal dimension capacity (refer to *Power Connections* table).
- Cross sections exceeding the terminal dimension capacity can cause impossible wiring, damage on the terminals or the equipment, or electrical insulation weakness and therefore shall be avoided.
- The tightening torque on aluminum wires termination must be adapted to prevent damage during installation, reduce creeping risk and prevent risk of overheating in operation⁽²⁾.
- In order to prevent risks from aluminum oxide low conductivity, the aluminum wire termination must be protected against corrosion or not submitted to corrosive substances.

Failure to follow these instructions will result in death or serious injury.

(1) : Sizing of the aluminum wires minimum cross section based on:

- NFPA70 Table 310.16 considering ambient temperature, insulation type and cable arrangement.
- Or IEC60364–5 considering ambient temperature, insulation type and cable arrangement.
- Or the application sizing standard for aluminum wire in the country of use.

(1) : Sizing of the aluminum wires maximum cross section mechanically allowable by the terminal (refer to the User Manual for terminal size information) and is made under the responsibility of the user.

(2) : Tightening torque on Aluminum terminals :

- Must be compatible with the acceptable range of the terminal if existing (refer to *Power Connections* table).
- Must be adapted to the current rating and the surface in contact.
- Is chosen under the responsibility of the user.

Wiring the Control Terminals

⚡ ⚠ DANGER

HAZARD OF FIRE OR ELECTRIC SHOCK

- Wire cross sections and tightening torques must comply with the specifications provided in this document.
- If you use flexible multi-wire cables for a connection with a voltage higher than 25 Vac, you must use ring type cable lugs or wire ferrules, depending on the wire gauge and the specified stripping length of the cable.

Failure to follow these instructions will result in death or serious injury.

When the soft starter transitions to operating state Fault, the mains contactor, if it is used in the wiring diagram, must be deenergized.

⚠ WARNING

UNANTICIPATED EQUIPMENT OPERATION

- Connect the coil of the mains contactor to output relay R1.

Failure to follow these instructions can result in death, serious injury, or equipment damage.

Control terminals layout

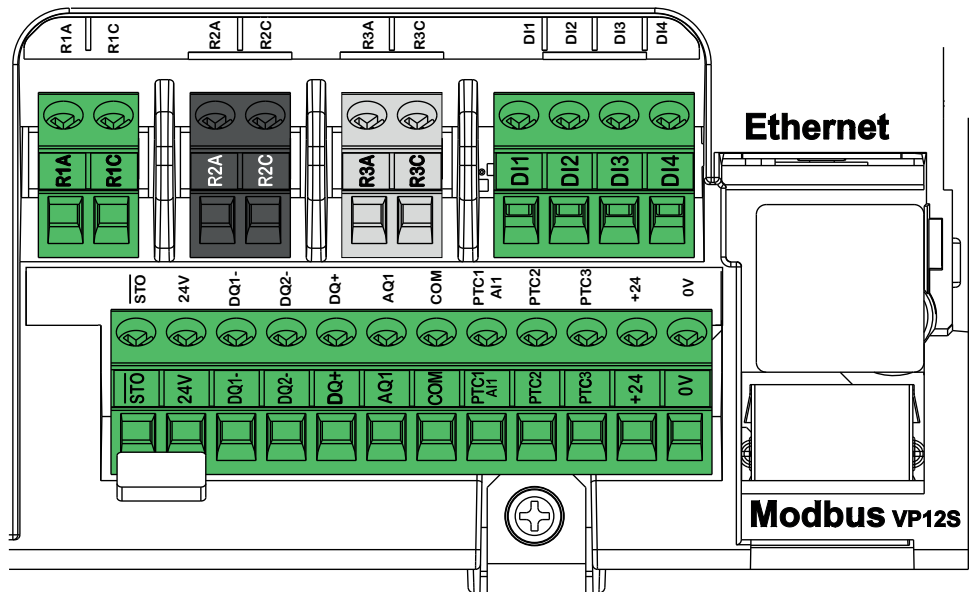

The control terminals are installed with one-way plug-in connectors Use wire cable ends (ferrules) if possible.

Ferrules are mandatory for wiring the A1 and A2 terminals to ensure an IP20 protection. The terminals are approved for stranded conductors and solid conductors.

NOTE:

- Modbus VP12S: This is the standard Modbus serial link marking. VP●S means connector with power supply, where 12 stands for the 12 Vdc supply voltage.

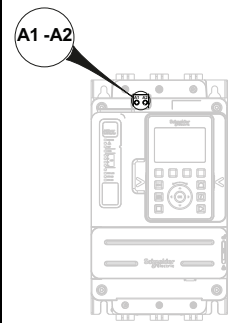

Control terminal wires specifications :

Tightening torque max N.m (lbf.in)	Min relay output wire cross section mm ² (AWG)	Other min wire cross section mm ² (AWG)	Max connection capacity mm ² (AWG)	Stripping length mm (in)	
				Min	Max
0.5 (4.4)	0.75 (18)	0.5 (20)	1.5 (16)	5.5 (0.2)	7.5 (0.3)

Those values are given for a single wire per terminal. Use a shunt to create a bridge between terminals if necessary.

Control supply terminals A1/A2 wires specifications :

Tightening torque max N.m (lbf.in)	Min wire cross section mm ² (AWG)	Max connection capacity mm ² (AWG)	Stripping length mm (in)	
			Min	Max
0.5 (4.4)	0.5 (20)	2.5 (14)	5.5 (0.2)	7.5 (0.3)

A1 and A2 wire connection for ATS490C79Y...ATS490M12Y

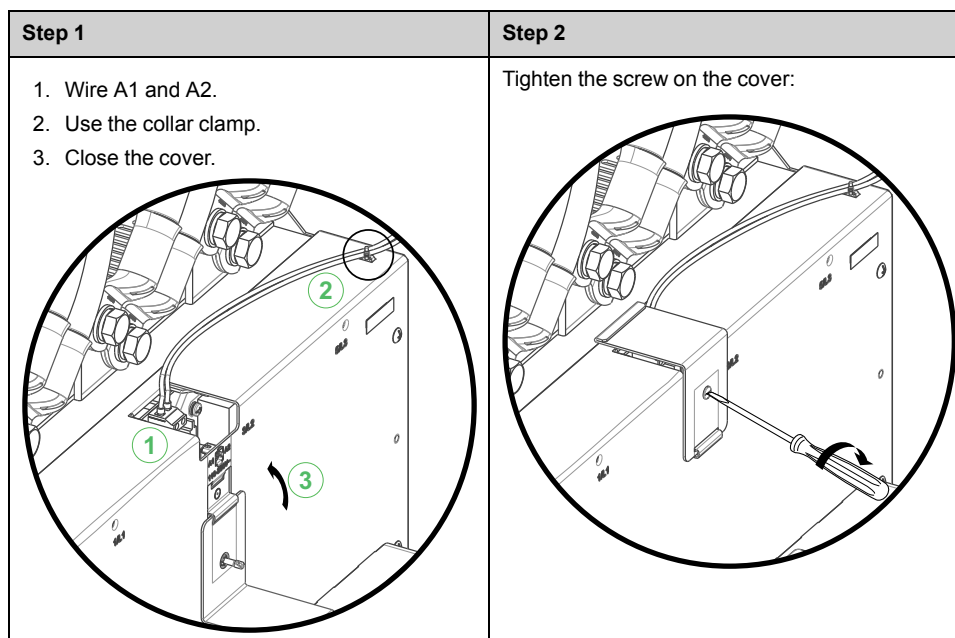

Control terminals function and characteristics

NOTICE
<p>INCORRECT VOLTAGE</p> <ul style="list-style-type: none"> Supply the control supply terminals A1 / A2 within a range of 110...230 Vac only <p>Failure to follow these instructions can result in equipment damage.</p>

Terminals	Function	I/O	Characteristics
A1	Control power supply	I	<ul style="list-style-type: none"> 110...230 Vac +10% – 15%, 50/60 Hz
A2			
R1A	Programmable NO relay R1 – Assigned to Operating state Fault by default	O	<ul style="list-style-type: none"> Max voltage: 250 Vac. Min. switching capacity: 100mA for 12Vdc Max. switching capacity on inductive load following IEC60947-2: <ul style="list-style-type: none"> 2A/250Vac for AC15 100 000 cycles 2A/30Vdc for DC13 150 000 cycles <p>Inductive load must be equipped with a voltage surge suppression device according to AC or DC operation with total energy dissipation greater than the inductive energy stored in the load.</p> <p>Refer to sections Output Relay with Inductive AC Loads, page 52 and Output Relay with Inductive DC Loads, page 53.</p>
R1C			
R2A	Programmable NO relay R2	O	
R2C			
R3A	Programmable NO relay R3	O	
R3C			
DI1	Digital Input 1	I	<ul style="list-style-type: none"> 4 x 24 Vdc digital inputs with 4.4 kΩ impedance U_{max} = 30 V I_{max} = 7 mA State 1: U > 11 V and I > 5 mA State 0: U < 5 V and I < 2 mA Response time: 2 ms ± 0.5 ms max
DI2	Digital Input 2	I	
DI3	Digital Input 3	I	
DI4	Digital Input 4	I	
0V	Common for +24	I/O	<ul style="list-style-type: none"> 0 V
+24	Supply for digital output	I/O	<ul style="list-style-type: none"> U_{min}: 19 Vdc U_{nominal}: 24 Vdc U_{max}: 30 Vdc I_{max}: 200 mA Isolated and protected against short-circuits and overloads, maximum current 200 mA. Can be used to supply the control block with an external 24Vdc supply if A1 and A2 are absent to keep communication with the product. <p>NOTE: The +24 terminal does not entirely substitute supply from A1 and A2. The motor cannot be controlled if you supply the ATS490 via only the +24 terminal. To control the motor, the ATS490 must be supplied via A1/A2 and the mains according to the application diagrams, page 37.</p>
DQ+	Digital output supply	O	24 Vdc digital output supply
DQ1	Programmable digital output 1	O	<ul style="list-style-type: none"> 2 open collector outputs compatible with level 1 PLC, IEC 65A-68 standard. Power supply +24 Vdc (min. 12 Vdc, max 30 Vdc) Max. current 100 mA per output with an external source Max frequency: 1kHz
DQ2	Programmable digital output 2	O	
AQ1	Programmable analog Output 1	O	<ul style="list-style-type: none"> Available signal: <ul style="list-style-type: none"> 0 —10 Vdc. Minimum load impedance 470 Ω 0 —20 mA ; 4 —20 mA, can be configured to custom value. Maximum load impedance 500 Ω Accuracy ± 1% for temperature range —10 to +60°C Resolution: 10 bits Linearity: ± 0.2% Sampling time: 5 ms + 1 ms maximum
COM	I/O common	I/O	<ul style="list-style-type: none"> 0 V

Terminals	Function	I/O	Characteristics
PTC1 / AI1	Motor thermal sensor connection	I	<ul style="list-style-type: none"> Configurable for PTC, PT100 (2/3 wires), PT1000 (2/3 wires) and KTY84 Total resistance of sensor circuit 750 Ω at 25°C Overheat trigger threshold: 2.9 kΩ \pm 0.2 kΩ Overheat reset threshold: 1.575 kΩ \pm 75 Ω Threshold for low impedance detection: 50 Ω \pm 10 Ω Open circuit threshold: 100 kΩ \pm 10 kΩ Refer to [Thermal monitoring] TPP , page 145 for more information on thermal sensors.
PTC2			
PTC3			
$\overline{\text{STO}}$	Safety Function STO Input	I	Refer to the Embedded Safety Function manual available on www.se.com
24V			

Checking Installation

Check List: Before Switching On

Unsuitable settings or unsuitable data or unsuitable wiring may trigger unintended movements, trigger signals, damage parts and disable monitoring functions.

▲ WARNING
<p>UNANTICIPATED EQUIPMENT OPERATION</p> <ul style="list-style-type: none"> • Only start the system if there are no persons or obstructions in the zone of operation. • Verify that a functioning emergency stop push-button is within reach of all persons involved in the operation. • Do not operate the product with unknown settings or data. • Verify that the wiring is appropriate for the settings. • Never modify a parameter unless you fully understand the parameter and all effects of the modification. • When commissioning, carefully run tests for all operating states, operating conditions and potential error situations. • Anticipate movements in unintended directions or oscillation of the motor. <p>Failure to follow these instructions can result in death, serious injury, or equipment damage.</p>

Check List: Mechanical Installation

Verify the mechanical installation of the entire soft starter system:

Step	Action	✓
1	Does the installation meet the specified distance requirements?	
2	Did you tighten all fastening screws according to the specified tightening torque?	

Check List: Electrical Installation

Verify the electrical connections and the wiring:

Step	Action	✓
1	Did you connect all protective Ground conductors?	
2	The correct tightening of the screws may be altered during assembly and wiring phases of the soft starter. Verify and adjust the tightening of all terminal screws to the specified nominal torque.	
3	Do all fuses and circuit breaker have the correct rating; are the fuses of the specified type? Refer to the information provided in the catalog.	
4	Did you connect or insulate all wires at the cable ends?	
5	Did you properly separate and insulate the control and power wiring?	
6	Did you properly connect and install all cables and connectors?	
7	Did you properly connect the signal wires?	
8	Are the required shield connections EMC-compliant?	
9	Did you take all measures for EMC compliance?	
10	Did you confirm that A1/A2 terminals are only supplied with 110...230 Vac?	
11	Did you confirm that the output of the relays R1 R2 and R3 are only connected to a maximum voltage of 250Vac / 30Vdc?	

Check List: Covers and Seals

Verify that all devices, doors and covers of cabinet are properly installed to meet the required degree of protection.

Product HMI

What's in This Part

Front Product LEDs	94
Display Terminal.....	95
Configure the display terminal	97

Front Product LEDs

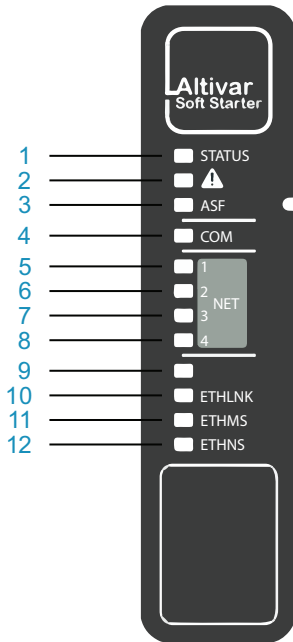

Item	LED	Description
1	STATUS	Bicolor Green/Yellow LED indicating soft starter states
2	Warning/Error	Red LED indicating whether a warn/error is active (in case of a warning, only if a warning is assigned to a warning group). It is in addition to warn/error info display on Display terminal LCD
3	ASF	Yellow LED indicating if Safety Function STO is activated or not activated.
4	COM	Yellow LED indicating Modbus serial activity on port RJ45 Modbus VP
5	NET 1	4 bicolor indicating Communication state of option module fitted into ATS490 slot. Indicators are Fieldbus option module dependant.
6	NET 2	
7	NET 3	
8	NET 4	
9	Reserved	
10	ETHLNK	Indicates Ethernet embedded port activity. For more information refer to the Ethernet manual (PKR63423).
11	ETHMS	Indicates Ethernet embedded port status. For more information refer to the Ethernet manual (PKR63423).
12	ETHNS	Indicates Ethernet embedded network port status. For more information refer to the Ethernet manual (PKR63423).

Display Terminal

General description of the Graphic Display Terminal VW3A1111

This Graphic Display Terminal is a local control unit plugged on the soft starter. The Display Terminal can be removed to be mounted on the door of the wall-mounted or floor-standing enclosure, using a dedicated door-mounting kit, refer to Mounting a graphic display terminal VW3A1111 on the door of the enclosure, page 77. The Display Terminal communicates with the soft starter using Modbus serial link. Both embedded Modbus connections (Modbus HMI & Modbus Fieldbus) can be used but only one Graphic Display Terminal must be connected at the same time.

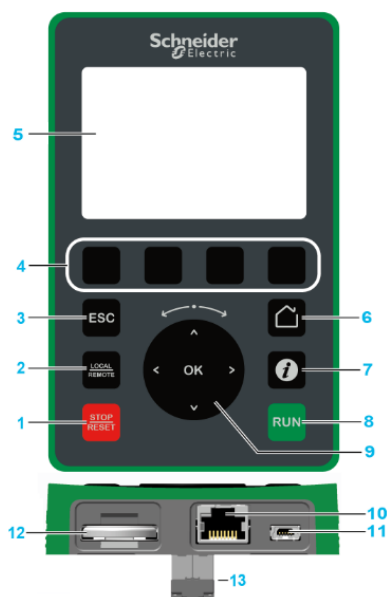

Key	
1	STOP / RESET: stop command / apply a Fault Reset.
2	LOCAL / REMOTE: used to switch between local and remote control of the soft starter, refer to <i>Set HMI local/remote command</i> , page 100
3	ESC: used to quit a menu/parameter, to clear the display of the triggered error or remove the currently displayed value in order to revert to the previous value retained in the memory.
4	F1 to F4: function keys used to access soft starter id, QR code when an error is triggered, quick view and tab submenus. NOTE: F2 & F3 can also be used to switch between unit and decimal in some screens such IP address. NOTE: Simultaneous press of F1 and F4 keys generates a screenshot file in the Graphic Display Terminal internal memory.
5	Graphic display.
6	Home: used to access the main menu.
7	Information: used to have more information about parameters. The selected parameter code is displayed on the first line of the information page.
8	RUN: executes the function.
9	Touch wheel / OK: used to save the current value or access the selected menu/parameter. The touch wheel is used to scroll fast into the menus. Up/down arrows are used for precise selections, right/left arrows are used to select digits when setting a numerical value of a parameter.
10	RJ45 Modbus serial female port: used to remote the Graphic Display Terminal.
11	MiniB USB port: used to connect the Graphic Display Terminal to a computer.
12	Battery: The battery have no use for the soft starter and there is no warning for display terminal low battery level.
13	RJ45 Modbus serial male port: used to connect the Graphic Display Terminal directly to the soft starter or through the door mounting kit.

NOTE: The function RUN of the **RUN** button and RESET of the **STOP / RESET** button are active only if the active command channel is the Graphic Display Terminal.

Screen description of the Graphic Display Terminal VW3A1111

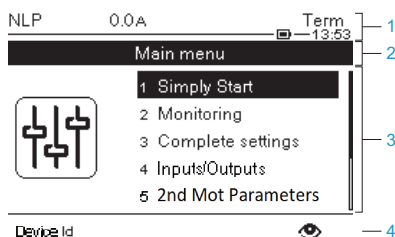

Key	
1	Display line.
2	Menu line: indicates the name of the current menu or submenu
3	Menus, submenus, parameters, values, bar charts, and so on, are displayed in drop-down window format on a maximum of five lines. The line or value selected by the navigation button is displayed in reverse video
4	Section displaying tabs (1 to 4 by menu), these tabs can be accessed using F1 to F4 keys

Screen description of the Graphic Display Terminal VW3A1111 — Display Line

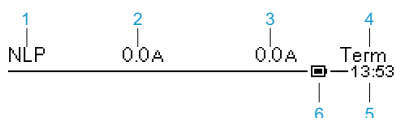

Key	
1	Soft starter state, refer to Soft Starter State, page 331.
2	Monitored parameter user defined, can be modified in [My preferences] .
3	Monitored parameter user defined, can be modified in [My preferences] .
4	Active control channel: <ul style="list-style-type: none"> • TERM: terminals • HMI: Graphic display terminal • MDB: integrated Modbus serial • CAN: CANopen® • NET: Fieldbus module • ETH: embedded Ethernet Modbus TCP/Ethernet IP • PWS: DTM based commissioning software
5	Present time. Refer to Set date and time, page 99.
6	Battery level. Level of battery embedded in the soft starter. Refer to Replace battery, page 318.

NOTE: If a warning is triggered and assigned to a warning group,  appears on the Graphic Display Terminal.

Configure the display terminal

What's in This Chapter

Select languages.....	98
Set date and time	99
Configure the screen contrast.....	99
Configure the Display Terminal backlight function	99
Customize time to lock Display terminal keys.....	100
Activate/deactivate Parameter "STOP/RESET" Display terminal button.....	100
Set HMI local/remote command	100
Customize the default screen parameter visualization	102
Select monitored parameter on Display line	103
List of parameters available for Default screen and display line	104
Customizable QR codes	104
Multipoint Screen	105

Select languages

The device contains some languages than can be selected through **[Language]** in **[My preferences]** menu.

- English (default)
- Chinese
- French
- German
- Italian
- Korean
- Russian
- Spanish
- Traditional Chinese
- Turkish
- Polish
- Brazilian

It is possible to upload additional languages.

1.	Download the latest version of language files here: Languages_Drives_VW3A1111
2.	Save the downloaded file on your computer.
3.	Unzip the file and follow the instructions of the ReadMe text file.

Set date and time

This menu provides the parameters to set date and time. This information is used for the time stamping of all logged data.

Access path: **[Device Management]** → **[Date & Time]**

HMI label	Setting	Factory setting
[Set Date/Time] <small>DTO</small>	–	–
<p>To update automatically the date and time data, the time server must be:</p> <ul style="list-style-type: none"> connected over Ethernet. configured in the webserver / DTM. SNTP service is configured. <p>Simple Network Time Protocol (SNTP) is used to keep device clocks synchronized.</p> <p>Date and time information should be available (time server available and configured and the internal battery, page 318 is functional) at soft starter power up to enable the time stamping of the logged data.</p> <p>Setting [Set Date/Time] gives access to the parameter [Time Zone], which can be used to set the offset between reference time and local time (by 15mn step).</p> <p>NOTE: The time is displayed in the top right-hand corner of the display terminal.</p>		
[Time Format] <small>TIME</small>	–	[24h]
<p>This parameter can be used to choose a time format to display on log file:</p> <ul style="list-style-type: none"> [24h]: Hour is displayed in a 24h format. [12h]: Hour is displayed in a 12h format. 		
[Date Format] <small>DATE</small>	–	[yyyy/mm/dd]
<p>This parameter can be used to choose a date format to display on log file:</p> <ul style="list-style-type: none"> [yyyy/mm/dd]: Date is displayed as yyyy/mm/dd. [dd/mm/yyyy]: Date is displayed as dd/mm/yyyy. [mm/dd/yyyy]: Date is displayed as mm/dd/yyyy. [dd/mm/yy]: Date is displayed as dd/mm/yy. [dd/mm]: Date is displayed as dd/mm. 		

Configure the screen contrast

Under the **[LCD settings]** menu, use the **[Screen Contrast]** parameter to configure the screen contrast.

Configure the Display Terminal backlight function

Under the **[LCD settings]** menu, use the **[Red Backlight]** parameter to configure the Display Terminal red backlight function in case of an error triggered.

Under the **[LCD settings]** menu, use the **[Standby]** parameter to configure the automatic backlight OFF time.

NOTE: Disabling the automatic standby function of the display terminal backlight will reduce the backlight service life.

Customize time to lock Display terminal keys

Under the **[LCD settings]** menu, use the **[Display Terminal locked]** parameter to configure the Display Terminal key locked.

The parameter **[Display Terminal locked]** can be set to **NO** or to 1...10 min.

NOTE: Press **ESC** and **Home** keys to Lock manually & unlock the Graphic Display Terminal keys. The **Stop** key remains active when the Graphic Display Terminal is locked.

NOTE: If cybersecurity auto logout is enable, **[Display Terminal locked]** is no more use. Please refer to Auto logout, page 226 for more information.

Activate/deactivate Parameter “STOP/RESET” Display terminal button

Under the **[Customization]** menu, use the parameter **[Stop Key Enable]** to set the priority for the **STOP / RESET** button on the display terminal.

- **[Stop Key Priority]** : Enable the **STOP / RESET** button. It is possible to press **STOP / RESET** key when active command channel is not the display terminal to stop the motor.
- **[Stop Key No Priority]** : Disable the **STOP / RESET** button if it is not the active channel set in **[Command channel]**

Setting this function to **[Stop Key No Priority] NO** disables the Stop key of the Display Terminals if the active command channel is not **[HMI] LCC**.

▲ WARNING

LOSS OF CONTROL

Only set this parameter to **[Stop Key No Priority] NO** if you have implemented appropriate alternative stop functions.

Failure to follow these instructions can result in death, serious injury, or equipment damage.

Set HMI local/remote command

From remote to local

Under the **[Customization]** menu, use the parameter **[HMI L/R cmd]** to set the **HMI local/remote command**:

- **[Stop On Switching]**: Apply a Stop order according to **[Type of stop]** when switching from Remote to Local.
- **[Bumpless]** : Apply no stop order when switching from Remote to Local.
- **[Disabled]** : Disable the **Local / Remote** display terminal key (factory setting).

From local to remote:

The operating state of the device after a transition from local command to remote command depends on the configuration of the device.

▲ WARNING**UNANTICIPATED EQUIPMENT OPERATION**

Verify that the transition from local command to remote command does not result in unsafe conditions.

Failure to follow these instructions can result in death, serious injury, or equipment damage.

Customize the default screen parameter visualization

Under the **[Customization]** menu → **[Display screen type]** menu, use the parameter **[Display value type]** to select the **HMI displayed value type**.

- **[Digital]** values, up to 2 parameters can be selected (factory setting):

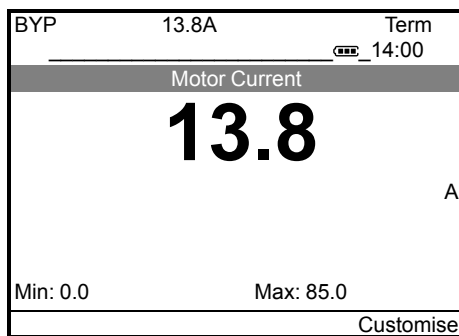

- **[Bar graph]**, up to 2 parameters can be selected and not all listed parameters are selectable:

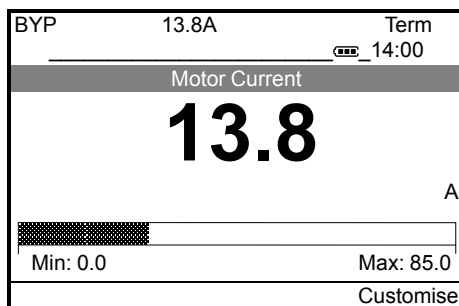

- **[List]** of values, up to 5 parameters can be selected:

By default, the device displays the **Nominal current** on the default screen.

Under the **[Customization]** menu → **[Display screen type]** menu.

Select the tab **[Parameter Selection]** to select the parameters to display on the default screen.

NOTE: The maximum number of selected parameters is 5.

[Display screen type] menu:

RDY 13.8A +50.0 Hz Term 14:00		
Display		
[Device State]		<input type="checkbox"/>
[Motor Current]		<input checked="" type="checkbox"/>
[Current RMS T1]		<input type="checkbox"/>
Type	Param	

Home page:

RDY 13.8A +50.0 Hz Term 14:00		
Display		
[Motor Current]	13.8A	
[Mains Frequency]	50.0Hz	
Locate	Customise	

• **[Vu Meter]** (1 parameter can be selected and not all listed parameters are selectable):

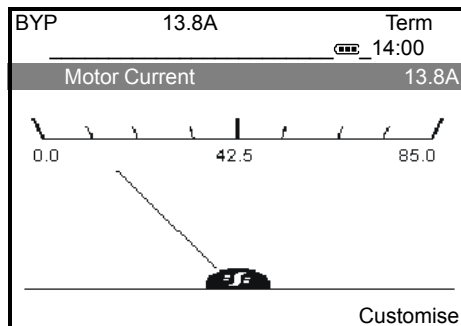

Select monitored parameter on Display line

2 monitored parameters can be selected:

RDY	0.00A	+50.0 Hz	Term
14:00			
Display			
[Device State]		<input type="checkbox"/>	
[Motor Current]		<input checked="" type="checkbox"/>	
[Motor Torque]		<input type="checkbox"/>	
[Mains Frequency]		<input checked="" type="checkbox"/>	

1. Go to **[Customization]**.
2. Select the parameter **[Param. Bar Select]** and check the monitored parameter to be displayed.

List of parameters available for Default screen and display line

The list is partially applicable for [List], [Vu Meter], [Bar graph], [Digital] and Display line.

- 1. [Device State]: *HMI status*
- 2. [Motor Current]: *Motor current*
- 3. [Current RMS T1]: *Current RMS Phase T1*
- 4. [Current RMS T2]: *Current RMS Phase T2*
- 5. [Current RMS T3]: *Current RMS Phase T3*
- 6. [Motor Torque]: *Motor torque*
- 7. [Mains Frequency]: *Mains frequency*
- 8. [Peak Elec Out Power]: *Peak electrical output power*
- 9. [Power Factor]: *Power factor*
- 10. [Motor Run Time]: *Motor run time*
- 11. [Power-on time]: *Power-on time*
- 12. [Nb Of Starts]: *Number of motor starts*
- 13. [AQ1]: *AQ1 physical value*
- 14. [Motor therm state]: *Motor thermal state*
- 15. [Device Thermal State]: *Device thermal state*
- 16. [Elc Energy Cons]: *Electrical energy consumed by the motor (KWh)*
- 17. [Elc Energy Cons]: *Electrical energy consumed by the motor (MWh)*
- 18. [Elc Energy Cons]: *Electrical energy consumed by the motor (GWh)*
- 19. [Elc Energy Cons]: *Electrical energy consumed by the motor (TWh)*
- 20. [Elc Egy Today]: *Electrical energy consumed TODAY by the motor (KWh)*
- 21. [Elc Egy Yesterday]: *Electrical energy consumed YESTERDAY by the motor (KWh)*

Customizable QR codes

Access path : [My preferences] → [QR code]

This menu gives access to 5 QR Codes:

- [QR code] *QRC* : scanning this QR code brings to a landing page on Internet with the information on the Technical product datasheet and a link for Schneider Electric App available for services.
- [My Link 1] *MYL1* to [My Link 4] *MYL4* : 4 QR codes customizable with the commissioning software. By default, scanning these QR codes brings to the same landing page as [QR code] *QRC*. To customize these QR codes with SoMove, go to “Device > HMI Personalization > QR codes”.

NOTE: The name “My link x” can also be changed during the customizing.

Multipoint Screen

Overview

Generally, a Graphic Display Terminal is connected to only one soft starter. However, communication is possible between a Graphic Display Terminal and several Altivar soft starters and Altivar drives, and connected on the same Modbus serial fieldbus via the RJ45 port (HMI or Modbus serial). In such a case, the multipoint mode is automatically applied on the Graphic Display Terminal.

The multipoint mode allows to:

- Have an overview of all the soft starters connected on the fieldbus (soft starter state and two selected parameters).
- Access to all the menus of each soft starter connected on the fieldbus.
- Command a stop on all the connected soft starters with the **STOP/RESET** key (irrespective of the present screen displayed). The type of stop can be individually configured on each soft starter with the parameter **[Stop Key Enable]** in the menu **[My preferences]**.

Except /Apart from the Stop function linked to the **STOP/RESET** key, the multipoint mode does not allow to apply a Fault Reset and command the soft starter via the Graphic Display Terminal: in multipoint mode, the Run key and the Local/Remote key are deactivated.

Prerequisites

To use the multipoint mode:

- The Graphic Display Terminal software version must be equal to or higher than V2.3.
- For each soft starter, the command channel must be set in advance to a value different from **[HMI]**.
- The address of each soft starter must be configured in advance to different values by setting the parameter **[Modbus Address]** in the **[Modbus Fieldbus]**.

Example of Installation Topology

The following figure gives a topology example using four soft starters, a Modbus "T" tap-off (VW3A8306TF03) and one Graphic Display Terminal (VW3A1111) linked to one Modbus splitter block (LU9GC3):

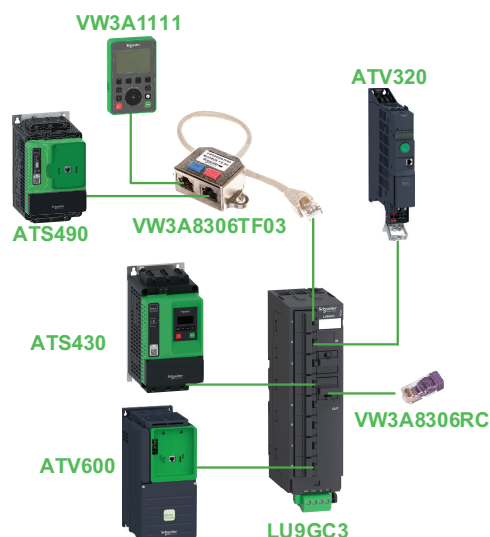

Screens for Multipoint Mode

The following figure gives the browsing between the different screens linked to the multipoint mode:

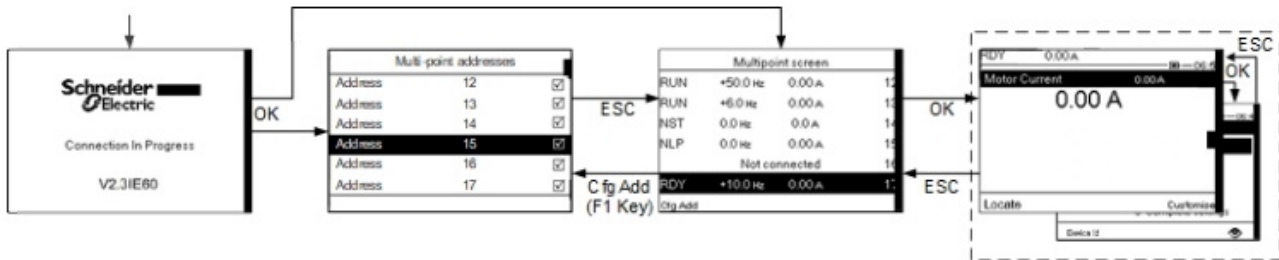

On the fieldbus common with the Graphic Display Terminal, if two or more soft starters are powered on, you access to the **[Connection in progress]** screen. If there is no address selected by the Graphic Display Terminal or no recognized address, the Graphic Display Terminal is locked on this screen. Press OK key to access to the **[Multi-point Addresses]** screen. Otherwise, if there are addresses-selected and one of them have been recognized by the Graphic Display Terminal, the screen switches automatically to **[Multipoint screen]**.

The **[Multi-point Addresses]** screen allows to select, by pressing OK key, the addresses of the soft starters you want to connect with. Up to 32 addresses can be selected (address setting range: 1...247). When all the addresses have been selected, press ESC key to access to the **[Multipoint screen]**.

NOTE: To help prevent a low refresh rate of the Graphic Display Terminal screen, do not select addresses that are not corresponding to soft starter addresses.

On the **[Multipoint screen]**, the touch wheel is used to navigate between the soft starter overviews. Access to the menus of the selected soft starter by pressing OK key. Return to the **[Multipoint screen]** by pressing ESC key.

NOTE: To access the **[Multi-point Addresses]** screen from the **[Multipoint screen]**, press F1 key.

If a soft starter triggers an error, the Graphic Display Terminal goes automatically to the **[Multipoint screen]** on the overview of the latest soft starter who has triggered an error.

The two parameters given in the soft starter overview can be modified individually on each soft starter in **[Param. Bar Select]**.

Commissioning

What's in This Part

First Power-Up	108
Define Parameter Visibility	113
Define Favorite Parameters List	117
Main Menu Presentation	118
Simply Start	119
Monitoring Settings.....	128
Other Settings.....	149
Inside the Delta of the Motor.....	156
Small Motor Test	160
Torque / Voltage Control	162
Start and Stop.....	164
Motor Preheating	168
Smoke Extraction.....	174
Voltage Boost	177
Borehole Pump	178
Reverse by External Contactor	179
Motor Jog	182
Anti-Jam.....	184
Second Set of Motor Parameters.....	190
Functions Compatibility Table.....	195
Command Channel	197
Input/Output Assignment	202

First Power-Up

When powering-Up the ATS490 for the first time by applying 110.230 Vac on A1 and A2 terminals, before operating it is mandatory to :

Set the language

Select the language. It can be changed after this setup, for more details see Select languages, page 98.

Set the Time Zone and Set the Date and Time.

Check the set time zone, date and time.

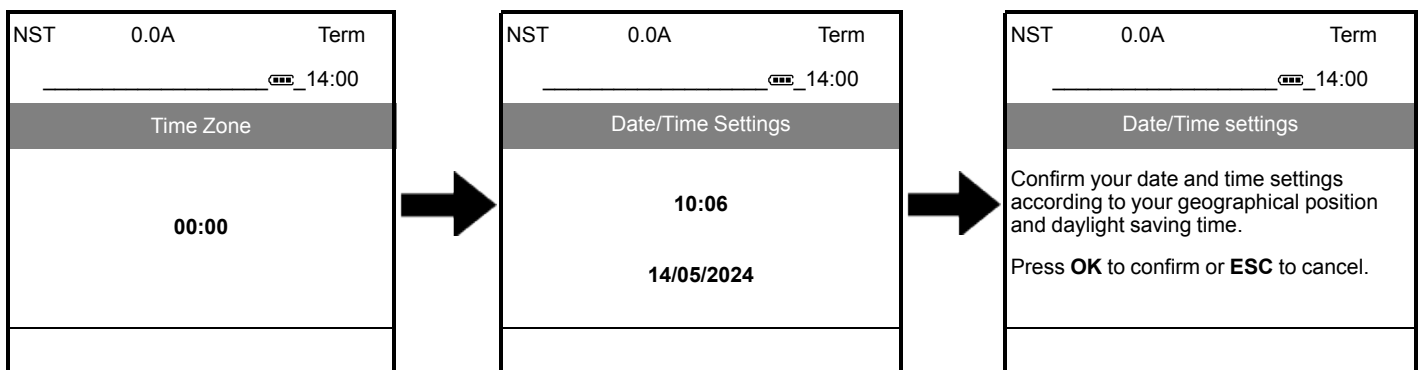

Press **OK** to confirm or **ESC** to cancel and return to the **[Time Zone]** screen.

Time Zone and Date and Time can be changed after this setup, for more details see Date and Time settings, page 99.

Go to product by setting cybersecurity policy (advanced, minimum)

To go into operational mode you need to configure the cybersecurity

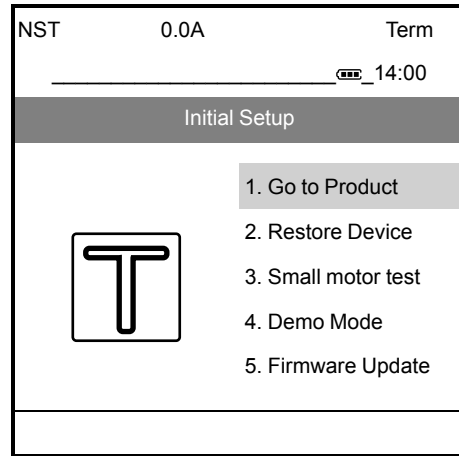

At the first power up, the soft starter ATS490 proposes minimum step-by-step settings in order to select the cybersecurity policy.

Step	Action
1	<ol style="list-style-type: none"> In the [Initial Setup] menu, scroll to [Go to product] and press OK. Choose a cybersecurity policy: <ul style="list-style-type: none"> To set no credentials to access this device, refer to step 2 – a. To set credentials, refer to step 2 – b. To load an existing cybersecurity policy already set and exported from a compatible device, refer to step 2 – c. <p>For more information about the cybersecurity policies, refer to <i>ATS490 Security Policy</i>, page 64.</p>
2 – a	<ol style="list-style-type: none"> Scroll to [Minimum Cybersec] and press OK. Read the message explaining the functionalities of this profile and press OK to validate and access the [Access Level] parameter or ESC to cancel the selection. Refer to <i>Define Parameter Visibility</i>, page 113 to set your access level and access the main menu of the device. <p>Result: The device is ready to be commissioned.</p> <p>Disabling this feature, no credentials will be required to access your process or machine. This setting is saved with the configuration and will be active if a configuration is loaded or copied.</p> <div style="border: 1px solid black; padding: 10px; margin: 10px 0;"> <p style="text-align: center;">▲ WARNING</p> <p style="text-align: center;">UNAUTHENTICATED ACCESS AND MACHINE OPERATION</p> <p>Do not disable the feature if your machine or process is accessible to unauthorized personnel either directly or via a network.</p> <p>Failure to follow these instructions can result in death, serious injury, or equipment damage.</p> </div> <p>For more information about the cybersecurity policies, refer to <i>ATS490 Security Policy</i>, page 64.</p>

Step	Action
2 – b	<ol style="list-style-type: none"> 1. Scroll to [Advanced Cybersec] and press OK. 2. Set a password and press OK to confirm it or ESC to cancel the selection. 3. Verify the set credentials and press OK to confirm them or ESC to cancel the selection. 4. Scroll down to display the confirmation message, press OK to validate this cybersecurity policy and access the [Access Level] parameter or press ESC to cancel the selection. 5. Refer to Define Parameter Visibility, page 113 to set your access level and access the main menu of the device. <p>Result: The device is ready to be commissioned.</p> <p>For more information about the cybersecurity policies, refer to <i>ATS490 Security Policy</i>, page 64.</p>
2 – c	<ol style="list-style-type: none"> 1. Scroll to [Load security policy] and press OK. 2. Scroll to the cybersecurity policy file (.secp) to upload on the device and press OK to transfer the file and access the [Access Level] parameter or ESC to cancel your selection. <p>Refer to <i>Soft Starter Configuration files</i>, page 213 for more information on soft starter configuration files.</p> <ol style="list-style-type: none"> 3. Refer to Define Parameter Visibility, page 113 to set your access level and access the main menu of the device. <p>For more information about the import / export of cybersecurity policies, refer to Import / Export Security Policy in <i>ATS490 Security Policy</i>, page 64.</p> <p>Result: The cybersecurity policy is set and the device is ready to be commissioned.</p>

NOTE: Once the steps are done (the cybersecurity policy is selected), the pre-operating procedure will not be required at the next power up and the device is ready for operation.

NOTE: The complete configuration of cybersecurity is accessible through *ATS490: DTM*.

Restore a device configuration (Situational)

In case of a product replacement or a similar situation, it is possible to restore a configuration. Refer to *Save & Restore a device image*, page 215 for more information.

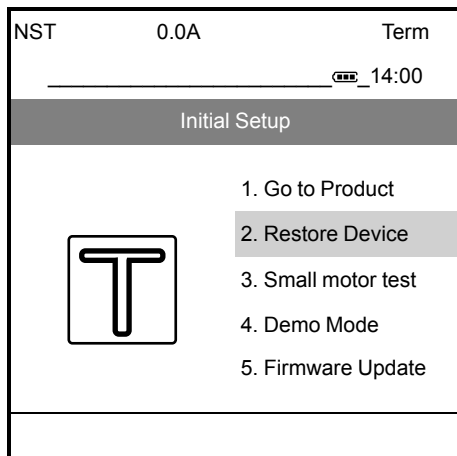

Step	Action
1	In the [Initial Setup] menu, scroll to [Restore device] and press OK .
2	Select [Load backup image] , press OK and select a .bki file. Refer to <i>Soft Starter Configuration files</i> , page 213 for more information on soft starter configuration files.
3	Read carefully the message on the display terminal and press OK to validate. Result: The device is ready to be commissioned. The previous device cybersecurity policy will be erased by this new configuration. For more information about the cybersecurity policies, refer to <i>ATS490 Security Policy</i> , page 64.

Perform a small motor test or a commercial demonstration (Situational)

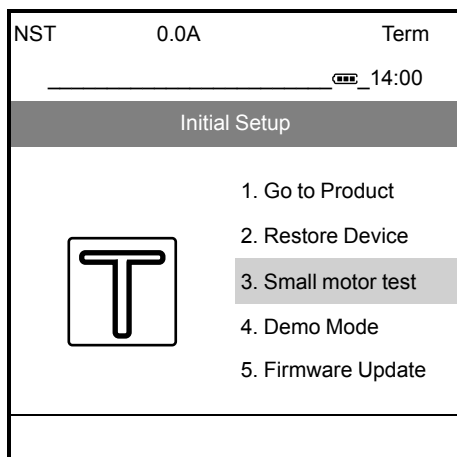

OR

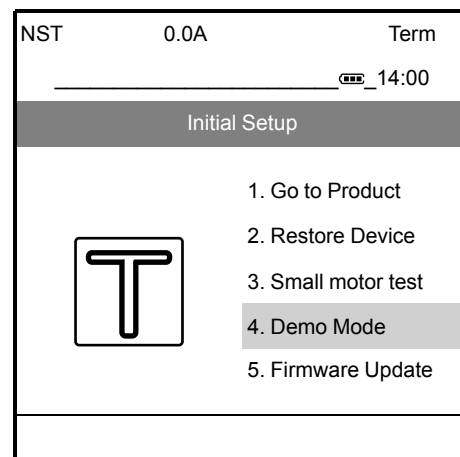

It is possible that in some cases, the user may not want or is not allowed to configure the cybersecurity or restore a device configuration.

For instance, when :

- Testing the soft starter mains supply wiring with **[Small Motor Test]**. For more details, refer to *Small Motor Test*, page 160.
- Performing a commercial demonstration of the soft starter for commercial purposes, by simulating a load and the presence of the mains supply without having to physically wire the product with **[Demo Mode]**. For more details, refer to *Perform a demonstration with the device*, page 332.

Check if the device is up to date (Situational)

It is possible to have a firmware package to be applied on the device.

Verify if there is a firmware update to apply by selecting [**Firmware update**] then Check for Update:

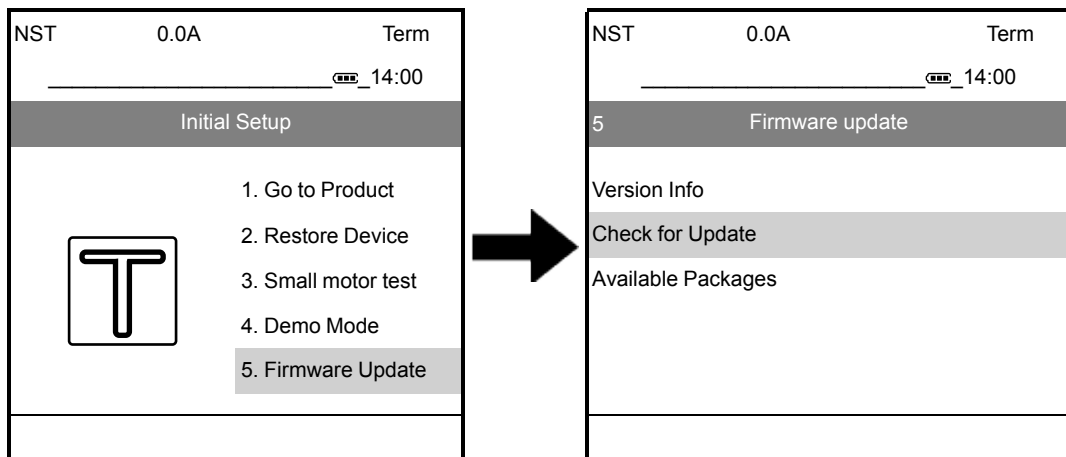

If the Product is up to date, two possibilities can appear:

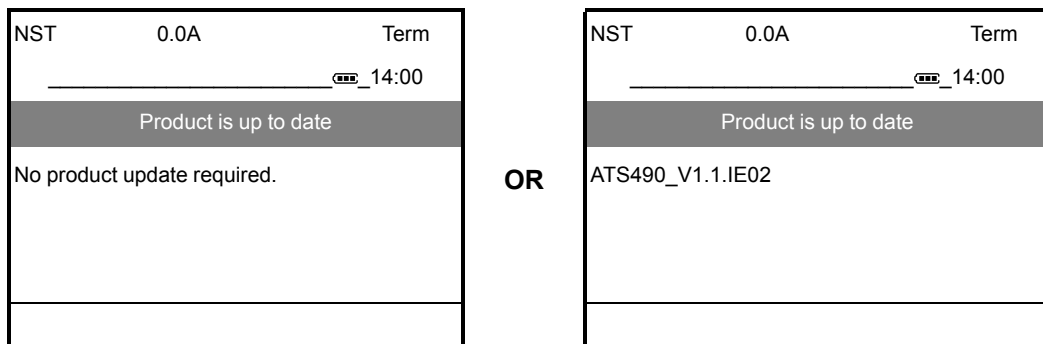

If firmware package is available, please follow this process:

Step	Action
1	Select the firmware package.
2	Apply the new firmware.
3	Pass through the Release Info step by pressing the OK button.
4	Pass through the FW UPDATE step by pressing the OK button.
5	These messages appear: <ol style="list-style-type: none"> 1. You are about to apply a new firmware. 2. Please wait for completion. 3. Product update is in progress. 4. Product restart in progress.
6	The final message "Firmware update has been correctly applied" appears. Press OK to continue the first power up procedure.



NOTE: To do a Firmware Update after your first power procedure, refer to Soft starter firmware update, page 219

Define Parameter Visibility

The device allows to hide/show defined directory or parameter of the Display terminal navigation menu. This could simplify the navigation by reducing number of directory or could reduce the risk of parameter modification by any users. Hiding a directory or a parameter does not deactivated the related function.

The device has 3 macro visibility level defined by the parameter **[Access Level]**. By default, the **[Access Level]** is set to **[Standard]**.

To change, go to **[My preferences]** → **[Parameter access]** menu, use and change **[Access Level]** according to :

[Menu]	All parameters		All the parameters of this menu are visible for this access level.
[Menu]			All the parameters of this menu are visible for this access level, except [Parameter]
	[Parameter]	-	
[Menu]		-	This menu and the parameters of this menu are not visible in this access level

NOTE: Not all sub-menus and parameters are represented in the following table. Refer to HMI Tree Navigation, page 337 for the complete listing of menus, sub-menus and parameters.

Menus	Sub-menus/Parameters	[Access Level]		
		[Basic]	[Standard]	[Expert] 
[My menu]		✓	✓	✓
[Simply Start]	All parameters	✓	✓	✓
[Monitoring]		✓	✓	✓
	[Gamma Sync Enable]	-	-	✓
[Complete settings]		-	✓	✓
	[Torque Limit]	-	-	✓
	[Stator Loss Comp]	-	-	✓
	[Control Mode]	-	-	✓
	[Command Switching]	-	-	✓
	[Cmd channel 2]	-	-	✓
	[Copy Ch1-Ch2]	-	-	✓
	[Start Pump Torq Limit]	-	-	✓
	[Smoke Extraction]	-	-	✓
	[Prod Restart Assign]	-	-	✓

Menus	Sub-menus/Parameters	[Access Level]		
		[Basic]	[Standard]	[Expert] 
[Input/Output]		✓	✓	✓
	[DQ1 Delay time]	-	-	✓
	[DQ1 Active at]	-	-	✓
	[DQ1 Holding time]	-	-	✓
	[DQ2 Delay time]	-	-	✓
	[DQ2 Active at]	-	-	✓
	[DQ2 Holding time]	-	-	✓
	[AQ1 Filter]	-	-	✓
	[AI1 filter]	-	-	✓
	[R2 Delay time]	-	-	✓
	[R2 Active at]	-	-	✓
	[R2 Holding time]	-	-	✓
	[R3 Delay time]	-	-	✓
	[R3 Active at]	-	-	✓
	[R3 Holding time]	-	-	✓

Menus	Sub-menus/Parameters	[Access Level]		
		[Basic]	[Standard]	[Expert] 
[Communication]		-	✓	✓
	[Term word order]	-	-	✓
[Display]	All parameters	✓	✓	✓
[Diagnostics]	All parameters	✓	✓	✓
[Device Management]		✓	✓	✓
	[Save/Load]	-	✓	✓
	[Factory settings]	-	✓	✓
	[Cybersecurity]	-	✓	✓
	[Clear device]	-	-	✓
[My preferences]		✓	✓	✓
	[Customization]	-	✓	✓

Define Favorite Parameters List











The following parameters allow to customize **[My menu]** MYMN.

[My menu] allows the user to save his favorite parameters in a single menu.

Access path: **[My preferences]** → **[Customization]** → **[My menu config.]**

HMI label	Setting	Factory setting
[Parameter Selection] <small>UMP</small>	–	–
This menu shows the content of [Complete settings] menu and allows to: <ul style="list-style-type: none"> Select the parameters visible in [My menu]. Remove the selected visible parameters from [My menu]. 		
[Display Selection] <small>MDP</small>	–	–
This menu shows the content of [Display] menu and allows to: <ul style="list-style-type: none"> Select the parameters visible in [My menu]. Remove the selected visible parameters from [My menu]. 		
[Selected list] <small>UML</small>	–	–
This menu displays the parameters selected via [Parameter Selection] and [Display Selection] . With the Graphic Display Terminal, this menu allows to sort and remove the selected parameters using the function keys (F1, F2 and F3). NOTE: Up to 25 parameters can be selected to be displayed in the customized menu.		
[My Menu] <small>MYMN</small>	–	–
With the Graphic Display Terminal, this parameter allows to rename [My menu] .		

Main Menu Presentation

 0 [My menu]	A list of parameters chosen by the user.
 1 [Simply Start]	Minimum parameters to start and stop a motor.
 2 [Monitoring]	Electrical and thermal monitoring functions.
 3 [Complete settings]	Advanced settings for fine-tuning.
 4 [Input/Output]	Inputs/Outputs configuration.
 5 [Communication]	Fieldbus communication configuration.
 6 [Display]	Monitoring of key values.
 7 [Diagnostics]	Soft starter history, current state and motor thermal state.
 8 [Device Management]	Cybersecurity, time setting, firmware update and factory settings.
 9 [My preferences]	Device and display terminal configuration.

Simply Start

What's in This Chapter

Example of Typical Configurations for Common Applications	120
Set Type of Wire Control	121
Set the Current & Current Limitation	122
Set Start Profile	124
Set Stop Profile	125

The  **[Simply Start]** menu provides:

- The minimum parameters to start and stop a class 10E induction motor in torque control.
- The list of ten last parameters directly modified by the user via the display terminal in the **[Modified parameters]** sub-menu. It is possible to edit the modified parameters from this sub-menu.
- JOG function is available in this sub-menu, if it is configured.

For typical configuration examples refer to Example of Typical Configurations for Common Applications, page 120.

In this chapter it is assumed that the soft starter uses the torque control law command to pilot a motor wired in-line with the mains supply.

For other configuration, refer to the **[Complete settings]** menu in the chapter "Start and stop".

Example of Typical Configurations for Common Applications

Application	[Current Limit] ILT (% of [Motor Nom Current] IN)	[Acceleration] ACC (s)	[Init Starting Torque] TQ0 (% of nominal torque)	[Type of stop] STT
Centrifugal pump	300	5 to 15	0	[Deceleration]
Submersible pump	300	Up to 2	20	[Deceleration]
Piston pump	350	5 to 10	30	[Deceleration]
Fan	300	10 to 40	0	[Freewheel]= or [Braking]
Cold compressor	300	5 to 10	30	[Deceleration]
Screw compressor	300	3 to 20	30	[Deceleration]
Centrifugal compressor	350	10 to 40	0	[Freewheel]
Piston compressor	350	5 to 10	30	[Deceleration]
Conveyor, transporter	300	3 to 10	30	[Deceleration]
Lifting screw	300	3 to 10	30	[Deceleration]
Drag lift	400	2 to 10	0	[Deceleration]
Elevator without passengers	350	5 to 10	20	[Deceleration]
Circular saw, band saw	300	10 to 60	0	[Braking]
Pulper, butchery knife	400	3 to 10	20	[Freewheel]
Agitator	350	5 to 20	10	[Deceleration]
Mixer	350	5 to 10	50	[Deceleration]
Grinder	450	5 to 60	0	[Braking]
Crusher	400	10 to 40	50	[Freewheel]
Refiner	300	5 to 30	40	[Deceleration]
Press	400	20 to 60	20	[Deceleration]

Set Type of Wire Control

Access path: [Simply Start] → [Simply start]

OR [Complete settings] → [Command channel]

HMI label	Setting	Factory setting
[2/3-Wire Control] TCC	—	[2-Wire Control] 2C
<i>2/3-wire control</i>		
<h2>⚠ WARNING</h2>		
<p>UNANTICIPATED EQUIPMENT OPERATION</p> <p>If this parameter is changed, the parameters [Auto Fault Reset] ATR and [2-wire type] TCT and the assignments of the digital and virtual inputs are partially reset to the factory setting.</p> <ul style="list-style-type: none"> Verify that this change is compatible with the type of wiring used. <p>Failure to follow these instructions can result in death, serious injury, or equipment damage.</p>		
<p>This parameter can be set to :</p> <ul style="list-style-type: none"> [2-Wire Control] 2C: Only one digital input needed for Run and Stop management. [3-Wire Control] 3C: Run and Stop are controlled by 2 different digital inputs. [Hardwired ctrl mode] LC3W: This mode depends on the 2 or 3 legacy wiring. <p>For more information refer to RUN and STOP Management, page 49.</p>		
[2-wire type] TCT	—	[Transition] TRN
<i>Type of 2-wire control</i>		
<p>This parameter can be accessed if [2/3-Wire Control] TCC is set to [2-Wire Control] 2C.</p>		
<h2>⚠ WARNING</h2>		
<p>UNANTICIPATED EQUIPMENT OPERATION</p> <p>Verify that the parameter setting is compatible with the type of wiring used.</p> <p>Failure to follow these instructions can result in death, serious injury, or equipment damage.</p>		
<p>[2-wire type] can be set to :</p> <ul style="list-style-type: none"> [Level] LEL : State 0 or 1 is taken into account for run (1) or stop (0) [Transition] TRN : A change of state (transition or edge) is necessary to initiate operation in order to avoid accidental restarts after a break in the supply mains <p>Refer to RUN and STOP Management, page 49 for more information.</p>		

Set the Current & Current Limitation

The following parameters can be used to have a smooth and progressive start of the motor by limiting the current in the motor during the start and ramp-up. This reduces the current surge at the start, the mechanical stress on the motor and reduces potential overloading of the electrical distribution network.

The value set to **[Motor Nom Current]** determines the current of the motor thermal monitoring, depending on which motor class is set. For more information regarding the motor thermal monitoring and the selection of the motor class, refer to Motor Thermal Protection Class, page 129.

Step	Action
1	Set [Motor Nom Current] to the value of the nominal motor current indicated on the motor nameplate.
2	Set the current limitation with the [Current Limit] parameter.

With the maximum load, the current limitation should be set at a high enough value to allow the motor to start. If the application requires more than 500% the soft starter current rating, a higher rated soft starter must be selected.

Access path: **[Simply Start] → [Simply start]**

OR [Complete settings] → [Motor parameters]

HMI label	Setting	Factory setting
[Motor Nom Current] <i>IN</i>	(1)	(2)
<p>Nominal current</p> <p>Adjust the value of [Motor Nom Current] according to the rated motor current indicated on the motor nameplate even if the soft starter is wired in the motor delta.</p> <p>(1) [Motor Nom Current] has two ranges of values:</p> <ul style="list-style-type: none"> 0.4...1 of soft starter rating (Ie, rated operational current) if [Inside Delta] is set to [No]. If the rated motor current is below 0.4 Ie, use a lower rated soft starter. 0.69...1.73 of Ie if [Inside Delta] is set to [Yes]. <p>For more information about [Inside Delta] refer to Connection Inside the Delta Of The Motor, page 156.</p> <p>(2) Factory setting of [Motor Nom Current] corresponding to the usual value of a 4-pole 400 V standardized induction motor and [Inside Delta] is set to [No] (soft starter connected in-line).</p> <p>The unit of the product display depends on the product size.</p> <ul style="list-style-type: none"> For sizes smaller than ATS490C25Y, the unit is 0.1 A. For ATS490C25Y and up, the unit is 1 A. 		

HMI label	Setting	Factory setting
[Current Limit] <i>ILT</i>	150...700%	400% of [Motor Nom Current] <i>IN</i>

Motor limiting current

The RMS motor line current will be limited to **[Current Limit]** multiplied by **[Motor Nom Current]**.

[Current Limit] max setting is limited to:

- in-line connection: $500\% \times I_e / I_N$
- inside delta connection: $500\% \times I_e / (I_N / \sqrt{3})$

In any case the **[Current Limit]** max setting will not exceed 700% of nominal motor line current.

If **[Inside Delta]** is set to **[Yes]**, the factory setting is 700% of **[Motor Nom Current]**.

The current limit setting is always active during start up and overrides all other settings.

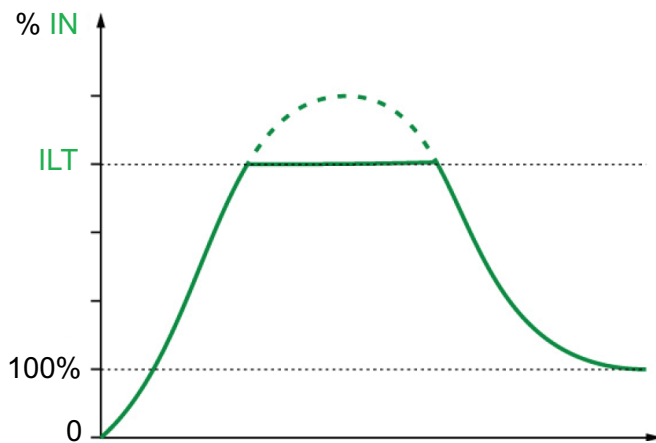

Example 1 in-line connection:

ATS490C21Y, with $I_e = 210$ A

[Motor Nom Current] = 195 A

[Current Limit] = 500% (under max setting : $500\% \times I_e / I_N = 5 \times 210 / 195 = 538\%$)

Current limitation = $500\% \times 195 = 975$ A

Example 2 inside delta connection:

ATS490C21Y, with $I_e = 210$ A

[Motor Nom Current] = 338 A

[Current Limit] = 500% (under max setting : $500\% \times I_e / (I_N / \sqrt{3}) = 5 \times 210 / (338 / \sqrt{3}) = 538\%$)

Current limitation = $500\% \times 338 = 1690$ A

Set Start Profile

The following parameters can be used to control the start of the motor by defining the ramp-up time and the initial torque applied.

[Acceleration] control the ramp-up time from the Run order to established regime.

[Init Starting Torque] set the initial starting torque.

Step	Action
1	Adjust the ramp time of the soft starter torque between 0 and the nominal torque with [Acceleration] .
2	Set the initial torque during the starting phase with the [Init Starting Torque] parameter.

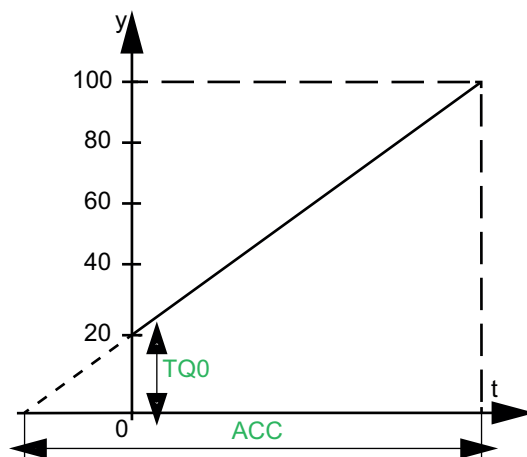

- y: Reference torque as % of nominal torque
- t: Time (s)
- **TQ0**: *Initial starting torque*
- **ACC**: *Acceleration ramp time*

By default, **[Control Mode]** is set to **[Torque Control]**, it is also possible to set in to **[Voltage Control]**. For more information, refer to Torque / Voltage Control, page 162.

Access path: **[Simply Start] → [Simply start]**

OR[Complete settings] → [Start & Stop]

Description	Setting range	Factory setting
[Acceleration] ACC	1...180 s	15 s
<p>Acceleration ramp time</p> <p>This parameter sets the ramp time from no torque to nominal torque.</p> <p>When the motor reaches established regime, the soft starter status changes to [Bypassed] BYP, even if the motor reaches established regime before the value set to [Acceleration].</p>		
[Init Starting Torque] TQ0	0...100% of nominal torque	20%
<p>Initial starting torque</p> <p>Initial torque setting during the starting phase. If set too low, the motor may not start as soon as the RUN command is applied.</p>		

Set Stop Profile

The following parameters can be used to control the stop of the motor.

There are three types of stop:

- **Freewheel:** No torque is applied to the motor by the soft starter. The motor stops in freewheel.
- **Deceleration:** The soft starter applies a decreasing torque / voltage to the motor to progressively decelerate it. The decreasing torque follows a defined ramp. This type of stop reduces the risk of water hammering with a pump and has no effect on high inertia applications.
- **Braking:** The soft starter applies a braking torque to the motor with current injections, slowing it down even if there is considerable inertia.

Set the parameter **[Type of stop]** to define the type of stop:

- If you set **[Type of stop]** to **[Freewheel]** no other settings are required.
- If you set **[Type of stop]** to **[Deceleration]** then set the controlled deceleration time using **[Deceleration]** parameter and set the conditions for stopping in freewheel using **[End Of Deceleration]** parameter.
- If you set **[Type of stop]** to **[Braking]** then set the braking gain with the **[Braking Level]** parameter and set the end of deceleration by injection with the **[DC Braking Time]** parameter.

The set type of stop will be active at the next Stop order.

NOTE:

- **[Braking]** is not compatible with **[Inside Delta]**. If **[Inside Delta]** is set to **[Yes]** when the braking is set, **[Type of stop]** will be set to **[Freewheel]**.
- Only one type of stop can be active at any given time.
- If a stop is given through the active command channel it will follow the configuration of **[Type of stop]**.
- If a stop is given by another active command channel than the active one it will be a **[Freewheel]**.
- There are also other possibilities when device is commanded by line channel. For more information, refer to the related communication guides.

Access path: **[Simply Start] → [Simply start]**

OR [Complete settings] → [Start & Stop]

Description	Setting range	Factory setting
[Type of stop] <i>STT</i>	–	[Freewheel] <i>F</i>
<p>Type of stop</p> <ul style="list-style-type: none"> • [Freewheel] : Freewheel stop. • [Deceleration] : Soft stopping by control of torque. • [Braking] : Dynamic braking stop. 		

Deceleration

Example with 80% of the nominal torque when a Stop order is applied:

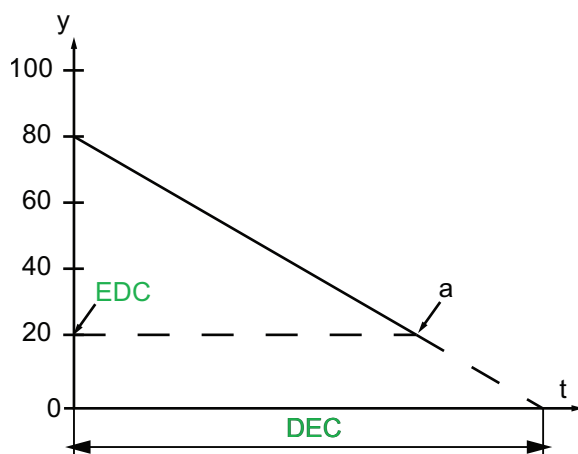

- y: Estimated torque (as a percentage of the nominal torque).
- a: End of controlled deceleration set by **[End Of Deceleration]**, motor stops in freewheel
- t: Time (s)
- DEC: **Deceleration ramp time**
- EDC: **End of controled deceleration threshold** (or **Threshold for changing to freewheel stop in voltage control** when **[Control Mode]** is set to **[Voltage Control]**, refer to Start and Stop, page 164 for more information).

Description	Setting range	Factory setting
[Deceleration] DEC	1...180 s	15 s
<p>Deceleration ramp time</p> <p>This parameter sets the deceleration ramp from the estimated applied torque at Stop order to no torque applied.</p> <p>Depending on the load characteristics, it is possible the motor may not stop to a standstill at the end of the ramp.</p> <p>This parameter can be accessed only if [Type of stop] or an error response is set to [Deceleration].</p>		
[End Of Deceleration] EDC	0...100% of estimated torque when a Stop order is applied	20%
<p>End of controled deceleration threshold</p> <p>As soon as the estimated applied torque is below the value set in [End Of Deceleration] (point “a” in the figure above), the motor stops in freewheel.</p> <p>This parameter can be accessed only if [Type of stop] or an error response is set to [Deceleration].</p>		

Braking

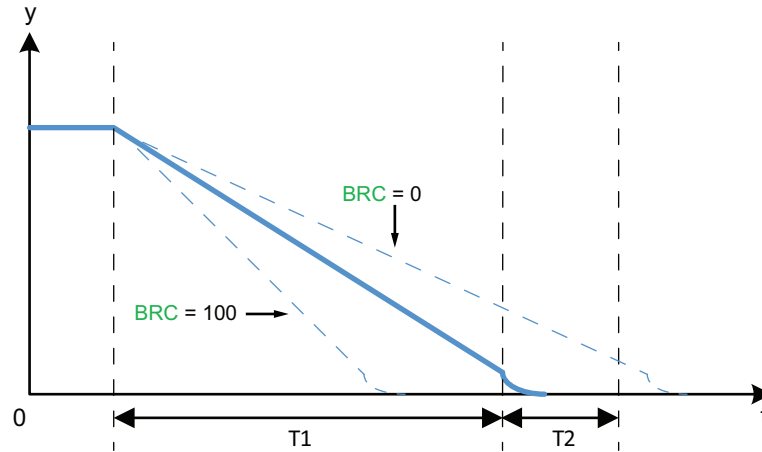

- y: Nominal speed.
- t: Time (s).
- T1: Dynamic braking time, ramp set by **[Braking Level]**.
- T2: Adjustment of motor stop by **[DC Braking Time]**.

Pseudo-continuous injection time: $T2 = T1 \times \text{[DC Braking Time]}$.

NOTE: Time T1 is dependant of **[Braking Level]**. The higher the value, the stronger is the braking and the faster is the ramp.

Description	Setting range	Factory setting
[Braking Level] <i>BRC</i>	0...100%	50%
<p>Dynamic braking level</p> <p>This parameter can only be accessed if [Type of stop] or an error response is set to [Braking].</p> <p>Braking is active according to the value set by [Braking Level].</p> <p>The total stopping time of the motor is configured by adjusting the injection time of the pseudo-direct current in the motor applied on two phases. See next parameter [DC Braking Time].</p>		
NOTICE		
<p>MECHANICAL STRESS</p> <ul style="list-style-type: none"> • Do not set a high value of [Braking Level] <i>BRC</i> if your application have a high inertia. • Verify that this value is suitable by performing a commissioning test under maximum load conditions. <p>Failure to follow these instructions can result in equipment damage.</p>		
[DC Braking Time] <i>EBA</i>	20...100%	20%
<p>DC continuous braking time</p> <p>This parameter can only be accessed if [Type of stop] or an error response is set to [Braking].</p> <p>This parameter adjusts the current injection time at the end of braking.</p> <p>Example:</p> <p>Dynamic braking = 10 s (T1)</p> <p>[DC Braking Time] = 20% corresponds to an injection time of 2 s</p> <p>[DC Braking Time] = 100% corresponds to an injection time of 10 s</p>		

Monitoring Settings

What's in This Chapter

Motor Thermal Protection Class	129
Process Overload.....	133
Process Underload	135
Too Long Start.....	136
Phase Inversion	137
Time Before Restart	138
Motor Thermal Estimation	138
Pumpcycle Monitoring	139
Phase Loss.....	140
Overvoltage & Undervoltage	141
Unbalanced Voltage & Unbalanced Current.....	143
Mains Frequency.....	143
Motor External Thermal Sensor	145
Gamma Sync.....	148

Motor Thermal Protection Class

Introduction

The soft starter continuously calculates the temperature rise of the motor based on the controlled nominal current **I_n** and the actual current absorbed.

Temperature rises can be caused by a low or high overload with a long or short duration. The tripping curves on the following pages are based on the relationship between the actual current absorbed **I** and the (adjustable) nominal motor current **I_n**.

Standard IEC 60947-4-2 defines the protection classes providing the starting capacities of the motor (warm or cold start) without thermal detected errors. Different protection classes are given for a **cold** state (corresponding to a stabilized motor thermal state, switched off) and for a **warm** state (corresponding to a stabilized motor thermal state, at nominal power).

The soft starter factory setting of the protection **[Motor Class]** is **[Class 10E]** .

The thermal state displayed by the parameter **[Motor Therm State]** in the menu **[Display] → [Thermal Monitoring]** corresponds to the maximum of iron thermal state and copper thermal state:

- An overload warning is activated if the motor exceeds 110% of the motor thermal state, if the warning **[Motor Overload Warn]** is set in a warning group in the **[Diagnostics] → [Warnings]** menu.

The relays R1, R2 and R3 can be assigned to the thermal detected error.

If the soft starter is switched-off, the thermal state is stored in EEPROM when the battery is present. When the soft starter is powered-on again, the duration of the power off is taken into account to calculate a new thermal state.

As long as the thermal state is above 110%, it is not possible to clear the detected error (except in case of power cycle of the soft starter).

If a special motor is used (flameproof, submersible, etc.) or in case of specific functions (such as Anti-Jam, Jog, preheating, 2nd motor etc...) thermal monitoring should be provided by external thermal sensors.

Cold State

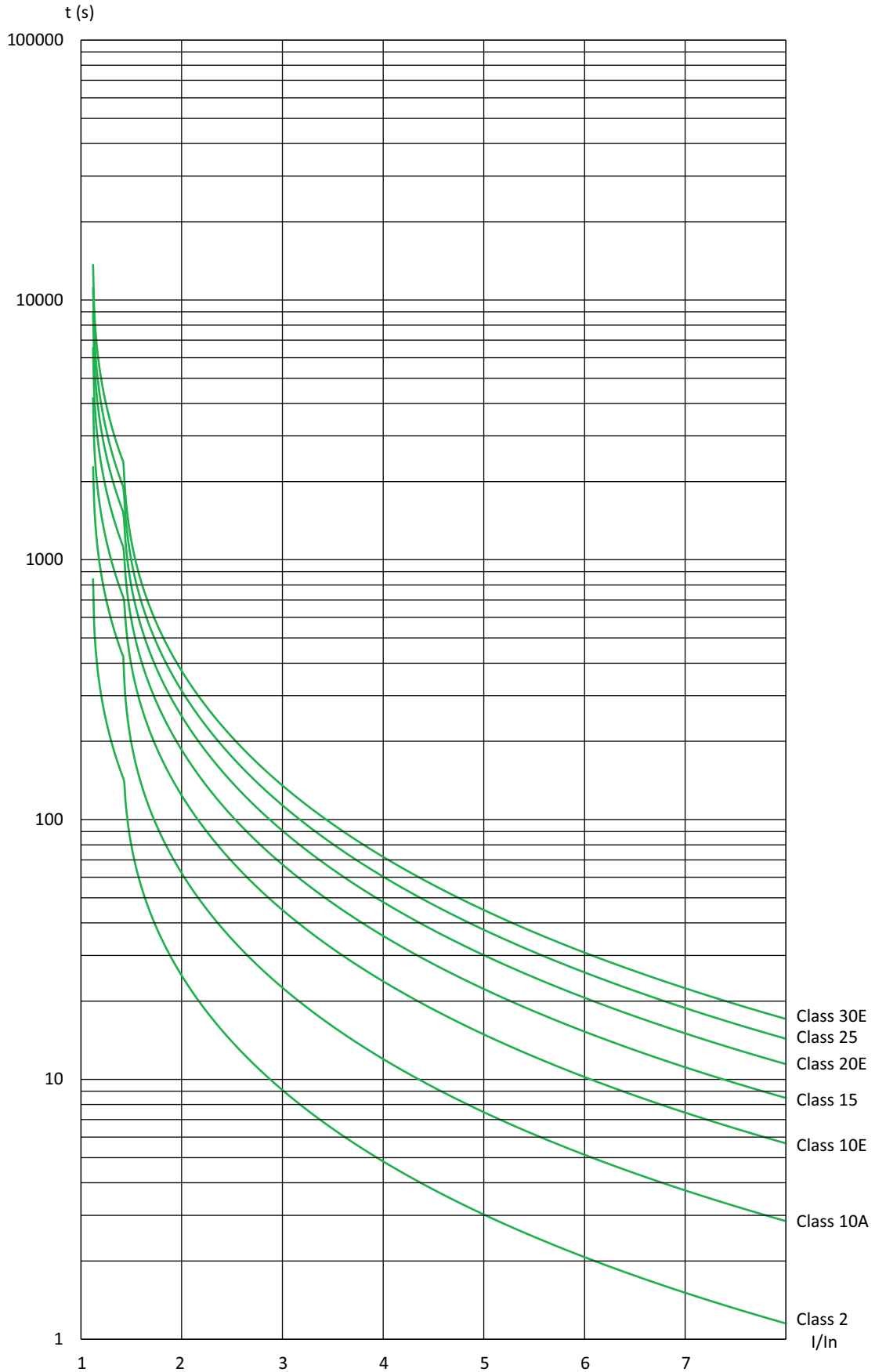

Triggering time for normal duty (class 10E)		Triggering time for heavy duty (class 20E)	
3 In	5 In	3.5 In	5 In
45 s	16 s	62 s	30 s

Warm State

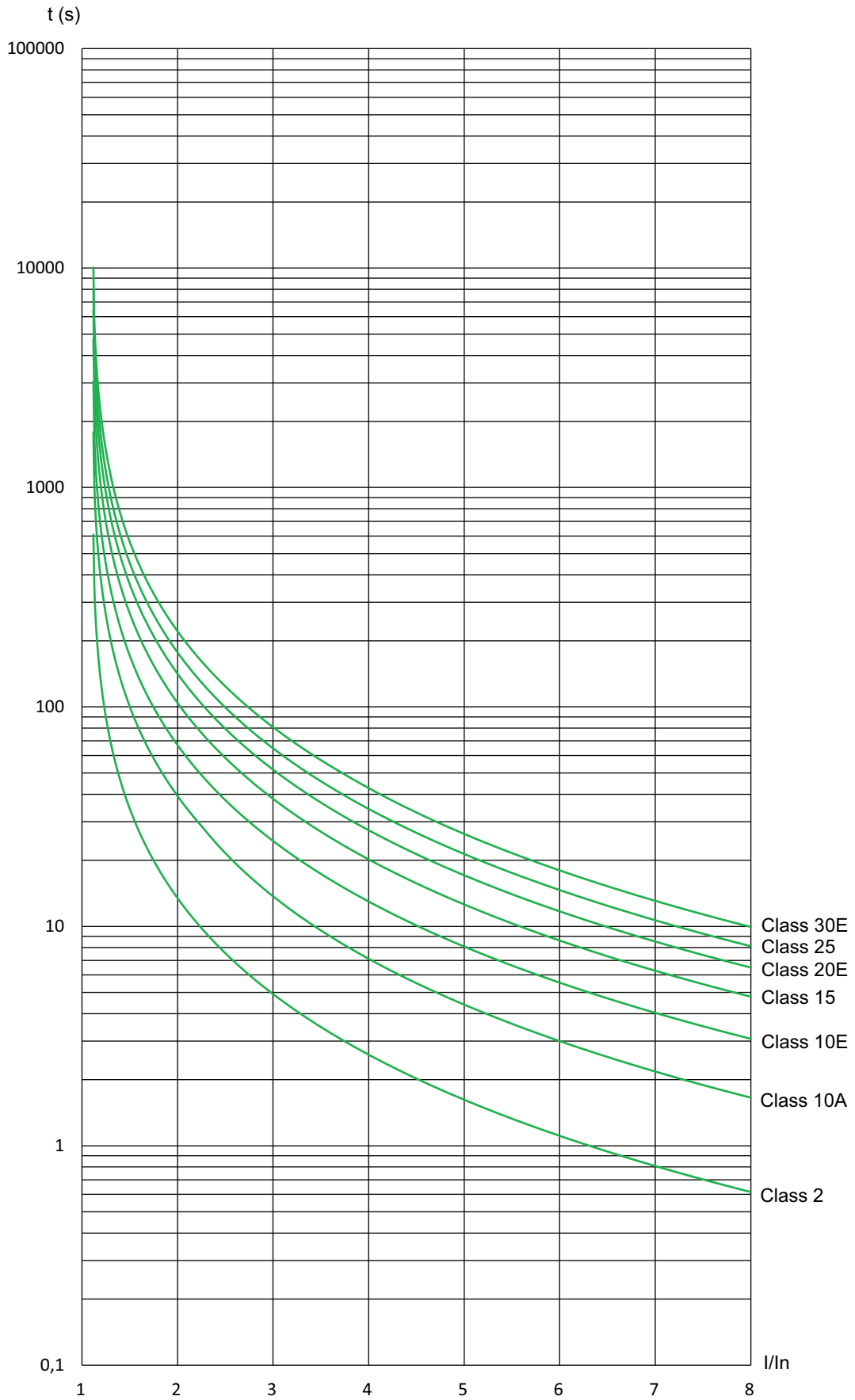

Triggering time for normal duty (class 10E)		Triggering time for heavy duty (class 20E)	
3 In	5 In	3.5 In	5 In
25 s	8 s	36 s	18 s

Commissioning

Access path: [Monitoring]

HMI label	Setting	Factory setting
[Motor Class] <i>THP</i>	–	[Class 10E] <i>10E</i>
<p>Motor thermal protection class</p> <p>Set your [Motor Class] from the motor name plate.</p> <ul style="list-style-type: none"> • [No Protection]: no motor monitoring. • [Class 2] <i>sub-class 2</i>. • [Class 10A] (normal duty). • [Class 10E] (normal duty, includes class 10). • [Class 15]. • [Class 20E] (heavy duty). • [Class 25]. • [Class 30E]. 		

Access path: [Display] → [Thermal Monitoring]

HMI label	Display	Factory setting
[Motor Therm State] <i>THR</i>	0...300 %	–
<p>Motor thermal state</p> <p>This parameter monitors the motor thermal state. 100% corresponds to the nominal thermal state at the nominal motor current set to [Motor Nom Current].</p> <p>This estimation of the motor thermal state is done according to [Motor Class] configuration.</p>		
[Time Before Starting] <i>THTR</i>	NA...3600s	–
<p>Motor thermal remaining time before restart</p> <p>This parameter can be used only if [Mot Therm Estimation] <i>THAC</i> is set to [Yes].</p>		

Access path: [Monitoring]

HMI label	Setting	Factory setting
[Mot Th State Reset] <i>RTHR</i>	[Yes] or [No]	[No]
<p>Reset motor thermal state</p> <p>This parameter resets the motor thermal state calculated by the soft starter.</p> <ul style="list-style-type: none"> • [Yes]: Reset calculated motor thermal state. • [No]: Function inactive. 		
NOTICE		
<p>MOTOR OVERHEATING</p> <p>Only reset the motor thermal state when the motor is cold otherwise the estimation of the temperature of the motor will be incorrect.</p> <p>Failure to follow these instructions can result in equipment damage.</p>		

Process Overload

This menu provides the parameters to configure the motor overload detection and management.

When the soft starter is in **[Bypassed]** state (established regime) and if the motor current exceeds the threshold set in **[Overload Threshold] LOC** for a duration longer than the value set in **[Ovld Detection Delay] TOL**, the soft starter behaves according to the value set in **[Overload ErrorResp] ODL**.

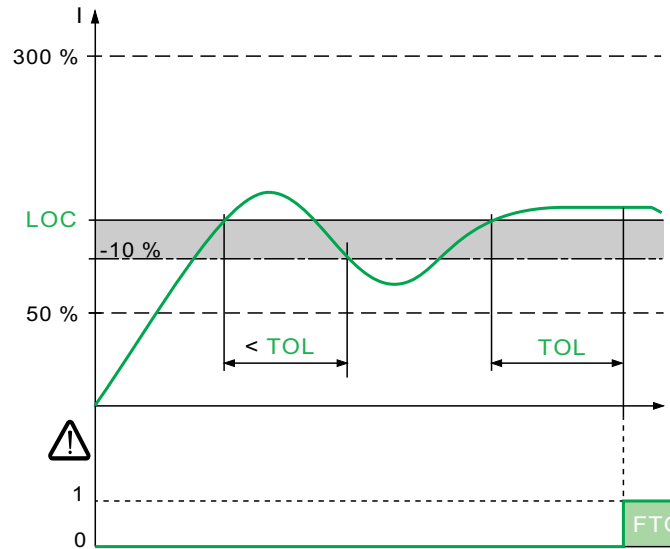

NOTE: process overload function can be used by the **[Anti-Jam]** function.

Access path: **[Monitoring] → [Process overload]**

HMI label	Setting	Factory setting
[Overload Activation] ODLA	[No] or [Yes]	[No]
<p>Overload activation</p> <p>This parameter enables overload monitoring when the motor is active.</p> <p>The parameters [Ovld Detection Delay] ,[Overload Threshold] and [Overload ErrorResp] are accessible for settings when [Overload Activation] is set to [Yes].</p> <p>NOTE: If [Anti-Jam Auto Trig] is set to [Current Overload], [Overload Activation] is forced to [Yes].</p>		
[Overload Threshold] LOC	50...200 or 300% of [Motor Nom Current]	80%
<p>Current overload threshold</p> <p>This parameter is used to set the motor current threshold value for [Overload Activation].</p> <ul style="list-style-type: none"> In line connection: [Inside Delta] is set to [No] → the maximum value is 200% of In. Inside delta connection: [Inside Delta] is set to [Yes] → the maximum value is 300% of In. 		
[Ovld Detection Delay] TOL	0...60 s	10 s
<p>Overload detection delay</p> <p>This parameter is to set the time delay to trigger the [Process Overload] error or the [Proc Overload Warn] when the [Overload Threshold] is reached.</p> <p>It is reset to zero if the current drops down below the value of [Overload Threshold] - 10% (hysteresis).</p>		

HMI label	Setting	Factory setting
[Overload ErrorResp] ODL	–	[Ignore]
<p>Response to overload error</p> <p>This parameter sets the soft starter behavior when the motor current exceeds the threshold set in [Overload Threshold] for a duration longer than the value set in [Ovid Detection Delay].</p> <ul style="list-style-type: none"> • [Ignore]: Trigger [Proc Overload Warn] OLA. The warning should be assigned to a warning group in [Warn groups config] to be visible when triggered. Refer to <i>Warning Messages</i>, page 289. • [Freewheel Stop]: Error [Process Overload] OLC is triggered and motor stops in freewheel. • [Deceleration]: Motor stops in deceleration and an error [Process Overload] OLC is triggered at the end of deceleration. • [Braking]: Motor stops in dynamic braking stop and an error [Process Overload] OLC is triggered at the end of stop. <p>NOTE: If [Anti-Jam Auto Trig] is set to [Current Overload], [Overload ErrorResp] is forced to [Ignore].</p>		
[Overload T.B.Rest.] FTO	0...6 min	0 min
<p>Ovid time Before Restart</p> <p>This parameter sets the duration of the [Process Overload] error and can't be reset during this time.</p> <p>This parameter is visible only if</p> <ul style="list-style-type: none"> • [Overload Activation] is set to [Yes]. • and [Overload ErrorResp] is different from [Ignore]. 		

Process Underload

This menu provides the parameters to configure the motor underload detection and management.

When the soft starter is in **[Bypassed]** state (established regime) and if the motor torque is below the threshold set in **[Underload Threshold]** LUL for a duration longer than the value set in **[Und Detect Delay]** ULT, the soft starter behaves according to the value set in **[Underload ErrorResp]** UDL.

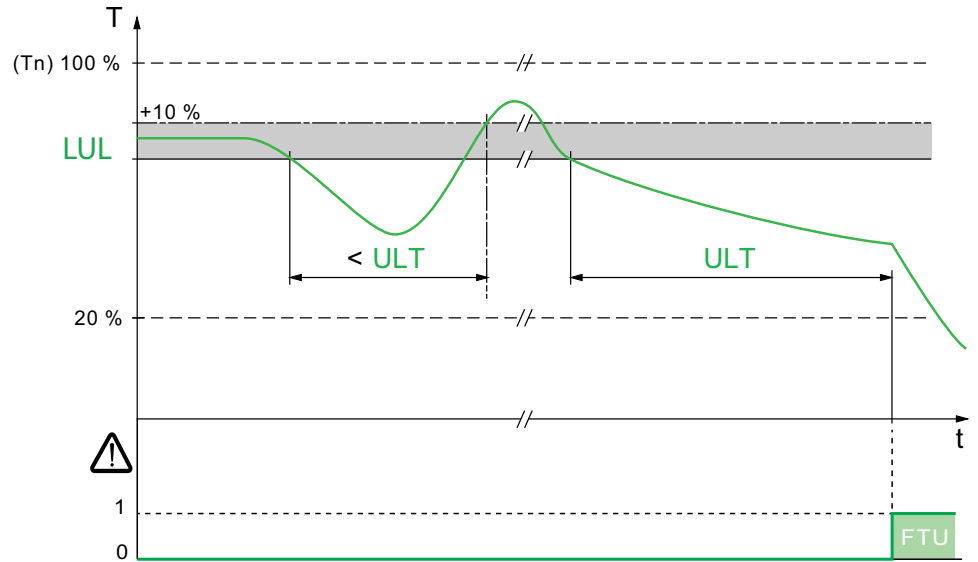

Access path: **[Monitoring]** → **[Process underload]**

HMI label	Setting	Factory setting
[Underload Activation] UDLA	[Yes] or [No]	[No]
Underload activation		
This parameter enable underload monitoring when the motor is running.		
The parameters [Und Detect Delay] , [Underload Threshold] and [Underload ErrorResp] are accessible for settings when [Underload Activation] is set to [Yes] .		
[Underload Threshold] LUL	20...100% of the nominal torque	60%
Underload threshold		
This parameter is used to set the motor torque threshold value for [Underload Activation] .		
[Und Detect Delay] ULT	0...60 s	60 s
Motor underload time		
This parameter is used to set the time delay to trigger the [Proc Underload] error or [Proc Undld Warn] when the [Underload Threshold] is reached.		
It is reset to zero if the torque rises above the value of [Underload Threshold] + 10% (hysteresis).		

HMI label	Setting	Factory setting
[Underload ErrorResp] UDL	—	[Ignore]
<p>Response to underload error</p> <p>This parameter sets the soft starter behavior when the motor torque is below the threshold set in [Underload Threshold] for a duration longer than the value set in [UndId Detect Delay].</p> <ul style="list-style-type: none"> [Ignore]: Trigger [Proc UndId Warn] ULA. The warning should be assigned to a warning group in [Warn groups config] to be visible when triggered. Refer to Warning Messages, page 289. [Freewheel Stop]: Error [Proc Underload] ULF is triggered and motor stops in freewheel. [Deceleration]: Motor stops in deceleration and an error [Proc Underload] ULF is triggered at the end of deceleration. [Braking]: Motor stops in dynamic braking stop and an error [Proc Underload] ULF is triggered at the end of stop. 		
[Underload T.B.Rest.] FTU	0...6 min	0 min
<p>UndId time Before Restart</p> <p>This parameter sets the duration of the [Proc Underload] error and can't be reset during this time.</p> <p>This parameter is visible only if:</p> <ul style="list-style-type: none"> [Underload Activation] is set to [Yes]. and [Underload ErrorResp] is different from [Ignore]. 		

Too Long Start

These parameters allow to monitor and prevent excessively long start times for the soft starter.

Access path: [Monitoring]

HMI label	Setting	Factory setting
[Too Long Start] TLS	10...999 s or [No] NO	[No] NO
<p>Excessive starting time</p> <p>If the starting time exceeds the value set in [Too Long Start], the soft starter triggers the error [Too Long Start Err]. The conditions for the end of starting are:</p> <ul style="list-style-type: none"> Mains voltage applied to the motor And motor current less than 2 In. <p>This parameter can be set to:</p> <ul style="list-style-type: none"> 10...999 seconds. [No]: Excessive starting time monitoring deactivated. 		
[Long Start Error Resp] STB	—	[Freewheel Stop]
<p>Response to a too long start error</p> <p>This parameter sets the reaction for a too long start behavior.</p> <p>This parameter can be set to:</p> <ul style="list-style-type: none"> [Freewheel Stop]: Error [Too Long Start Err] TLSF is triggered and motor stops in freewheel. [Deceleration]: Motor stops in deceleration and an error [Too Long Start Err] TLSF is triggered at the end of deceleration. <p>NOTE: This parameter can be accessed only if [Too Long Start] is not set to [No].</p>		

Access path: **[Display]** → **[Motor parameters]** → **[Others]**

HMI label	Setting	Factory setting
[Real Start Time] <small>RSTT</small>	0...1000 s	–
This parameter shows the real start time to help define the value of [Too Long Start] parameter.		

Phase Inversion

This parameter defines and monitors the direction of rotation of the motor in accordance to the mains.

Access path: **[Monitoring]**

HMI label	Setting	Factory setting
[Phase Inversion Mon] <small>PHR</small>	–	[No] <small>NO</small>
<p>Phase Inversion Monitoring</p> <p>If the mains input phases are not in the configured order, the soft starter triggers and displays the error [Phase Inversion].</p> <ul style="list-style-type: none"> [No]: automatic detection, the first run order gives the direction. [123]: direct network (L1 - L2 - L3). [321]: indirect network (L1 - L3 - L2). <p>The configuration this parameter defines the Forward direction.</p> <p>If an external function is configured, such as Reverse by external contactor or Anti-jam, [Phase Inversion Mon] must be configured to check the direction of motor rotation.</p>		

Access path: **[Display]** → **[Motor parameters]** → **[Others]**

HMI label	Setting	Factory setting
[Phase Direction] <small>PHE</small>	–	–
<p>Detected phase direction</p> <p>Detect the phase inversion if [Phase Inversion Mon] <small>PHR</small> is configured.</p> <ul style="list-style-type: none"> [No]: No direction recognized. [123]: direct network (L1 - L2 - L3). [321]: indirect network (L1 - L3 - L2). 		

Time Before Restart

Access path: **[Monitoring]**

HMI label	Setting	Factory setting
[Time Before Restart] <i>TBS</i>	0...999 s	2 s

Time before motor restart

This parameter sets the time delay between two starts. It helps to prevent too many starts in a short time which may overheat the motor.

NOTE: While the **[Time Before Restart]** *TBS* timer is running, the **[Wait for Restart]** *TBS* status is displayed on the graphic display terminal.

NOTE: Other delays can impact the duration of time before restart. Please refer to *How to interpret and react to a TBS state*, page 328 for the complete list.

If the motor stops with :

- **[Type of stop]** set to **[Freewheel]** the time delay **[Time Before Restart]** starts when a Stop order is applied.
- **[Type of stop]** set to **[Deceleration]**, the time delay **[Time Before Restart]** starts as soon as the time, dependant of the setting **[End Of Deceleration]**, is elapsed.
- **[Type of stop]** set to **[Braking]**, the time delay **[Time Before Restart]** starts as soon as the motor stops rotating due to the dynamic braking time, ramp set by **[Braking Level]** (see timer T1 representation).

If **[2/3-Wire Control]** is set to **[Hardwired ctrl mode]** or to **[2-Wire Control]** and **[2-wire type]** is set to **[Level]**, when the Run command is applied and maintained, the start of the motor can be delayed for the amount of time set to the parameter **[Time Before Restart]**.

▲ WARNING

UNANTICIPATED EQUIPMENT OPERATION

- Verify that setting a high value to the parameter **[Time Before Restart]** does not result in unsafe conditions.
- Always consider that the equipment is in the operating state Operation Enabled as soon as a Run command is applied even if the time delay to restart is not elapsed.

Failure to follow these instructions can result in death, serious injury, or equipment damage.

If **[2/3-Wire Control]** is set to **[3-Wire Control]** or to **[2-Wire Control]** and **[2-wire type]** is set to **[Transition]**, the Run command is not taken into account.

Motor Thermal Estimation

This function uses the internal thermal estimation to delay the next start. This delay corresponds to the amount of time to return below a threshold estimated via the thermal class of the motor.

HMI label	Setting	Factory setting
[Mot Therm Estimation] <i>THAC</i>	–	[No]

Motor thermal Estimation Activation

- **[No]:** *Time before motor restart* function deactivated.
- **[Yes]:** *Time before motor restart* function activated.

Refer to *How to interpret and react to a TBS state*, page 328 for other possible delays.

Pumpcycle Monitoring

This function is based on cyclic start management allows to monitor application (pump), motor and/or soft starter from overheating. It allow a maximum number of starts in a time window.

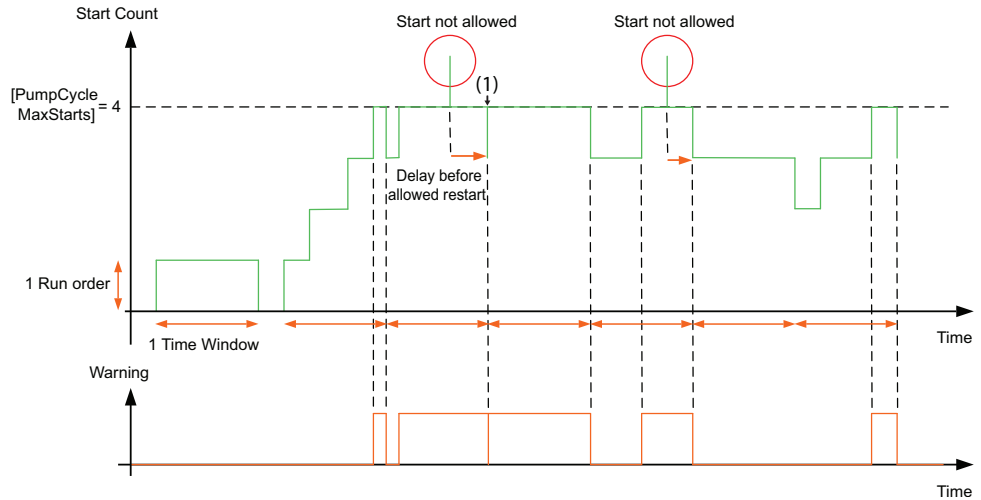

(1) : Behavior with run order maintained in **[2-Wire Control]** on **[Level]** or in **[Hardwired ctrl mode]**. For more information refer to Set Type of Wire Control, page 121.

- An internal counter counts the number of starts.
- The internal counter is incremented by one each time the motor is started.
- The internal counter is decreased by one every one Time Window.
- If the internal counter reaches the **Pump cycle maximum allowed starts**, a warning is triggered. The warning should be assigned to a warning group in **[Warn groups config]** to be visible when triggered. Refer to **Warning Messages**, page 289.

NOTE: If anti-jam function is used with this function, an execution of anti-jam sequence increment by one the internal counter.

Access path: **[Monitoring]**

HMI label	Setting	Factory setting
[PumpCycle Monitor] PCPM	-	[No]
<p>Pump cycle monitoring mode This parameter can be set to:</p> <ul style="list-style-type: none"> • [No] : Pump cycle monitoring disabled. • [Mode 1]: Pump cycle monitoring is enabled. Power-Off time is not managed and the counter is reset at each Power-Up. • [Mode 2] : Pump cycle monitoring is enabled. Power-Off time is managed and the counter is initialized according to time passed without Power using the RTC (since last power-off). <p>Refer to How to interpret and react to a TBS state, page 328 for other possible delays.</p>		
[PumpCycle MaxStarts] PCPN	1...99	6
<p>Pump cycle maximum allowed starts Maximum allowed starts in time window.</p> <p>This parameter can be accessed if [PumpCycle Monitor] is configured.</p>		
[PumpCycle timeframe] PCPT	1...3600 min	60 min
<p>Pump cycle timeframe Time window in which pump starts are counted and compared to max allowed count.</p> <p>This parameter can be accessed if [PumpCycle Monitor] is configured.</p>		

NOTE: A modification of **[PumpCycle MaxStarts]** and **[PumpCycle timeframe]** is not taken into account immediately, but once the internal timer (Time Window **PCPT/PCPN**) has elapsed.

Phase Loss

These parameters allow to define and monitor a motor loss of phase.

Access path: **[Monitoring]**

HMI label	Setting	Factory setting
[Phase Loss Monit] <small>PHP</small>	[Yes] or [No]	[Yes]
Phase loss monitoring		
 DANGER		
HAZARD OF ELECTRIC SHOCK, EXPLOSION OR ARC FLASH If output phase monitoring is disabled, phase loss and, by implication, accidental disconnection of cables, are not detected. <ul style="list-style-type: none"> Verify that the setting of this parameter does not result in unsafe conditions. Failure to follow these instructions will result in death or serious injury.		
This parameter enables motor phase loss monitoring. If the motor current is below the threshold set in [Phase Loss Thd] and [Phase Loss Monit] is set to [Yes] , the soft starter triggers the [Output Phase Loss] error. <ul style="list-style-type: none"> [No]: phase loss monitoring disabled [Yes]: phase loss monitoring enabled 		
[Phase Loss Thd] <small>PHL</small>	1...10% of soft starter current rating	5%
Phase loss threshold		
If the motor current drops down below this threshold on one phase, two or all three phases for 0.5 seconds, the soft starter triggers the [Output Phase Loss] error. This parameter is visible if [Phase Loss Monit] is set to [Yes] .		

More information on which phase/phases is/are lost available in chapter Diagnostic Data.

Overvoltage & Undervoltage

Undervoltage and overvoltage will modify the consumption of current, may cause overheating, and affect the efficiency and motor lifetime.

Overvoltage

If the mains voltage exceeds the threshold set in **[Overvoltage Thld]** *OSD* for a duration longer than the value set in **[OV detection delay]** *OSFD*, the soft starter behaves according to the value set in **[Voltage Error Resp]** *MVFB*.

Access path: **[Monitoring]** → **[Overvoltage]**

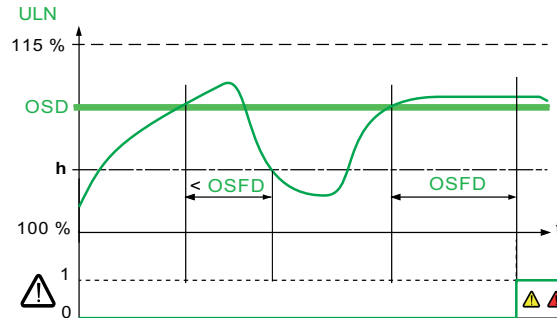

Legend:

- **h**: the timer **[OV detection delay]** is reset to zero if the voltage drops below 95 % of **[Overvoltage Thld]**.
- : **[Overvoltage Warn]**
- : **[Mains Nom. Volt. Error]**

HMI label	Setting	Factory setting
[Overvoltage Thld] <i>OSD</i>	110...115% of <i>Mains voltage</i> <i>ULN</i>	110%
Overvoltage threshold		
This parameter is used to set the mains voltage threshold value for triggering a [Mains Nom. Volt. Error] <i>NOSF</i> error.		
[OV detection delay] <i>OSFD</i>	1...10 s	2 s
Overvoltage detection delay		
This parameter is used to set the time delay to trigger an [Mains Nom. Volt. Error] <i>NOSF</i> error when the [Overvoltage Thld] is reached.		
The timer [OV detection delay] is reset to zero if the voltage drops below 95 % of [Overvoltage Thld] .		
[Voltage Error Resp] <i>MVFB</i>	–	[Ignore]
Response to an under/overvoltage error		
This parameter sets the soft starter behavior when the mains voltage exceeds the threshold set in [Overvoltage Thld] for a duration longer than the value set in [OV detection delay] .		
<ul style="list-style-type: none"> • [Ignore]: Trigger [Overvoltage Warn] <i>OSA</i>. The warning should be assigned to a warning group in [Warn groups config] to be visible when triggered. Refer to <i>Warning Messages</i>, page 289. • [Freewheel Stop]: Error [Mains Nom. Volt. Error] <i>NOSF</i> is triggered and motor stops in freewheel. • [Configured Stop]: Motor stops according to the value set in [Type of stop], [Overvoltage Warn] is triggered. • [Deceleration]: Motor stops in deceleration and an error [Mains Nom. Volt. Error] <i>NOSF</i> is triggered at the end of deceleration. • [Braking]: Motor stops in dynamic braking stop and an error [Mains Nom. Volt. Error] <i>NOSF</i> is triggered at the end of stop. 		

Undervoltage

If the mains voltage is below the threshold set in **[Undervoltage Thld]** *USD* for a duration longer than the value set in **[UV Detection Delay]** *USFD*, the soft starter behaves according to the value set in **[Voltage Error Resp]** *MVFB*.

Access path: **[Monitoring]** → **[Undervoltage]**

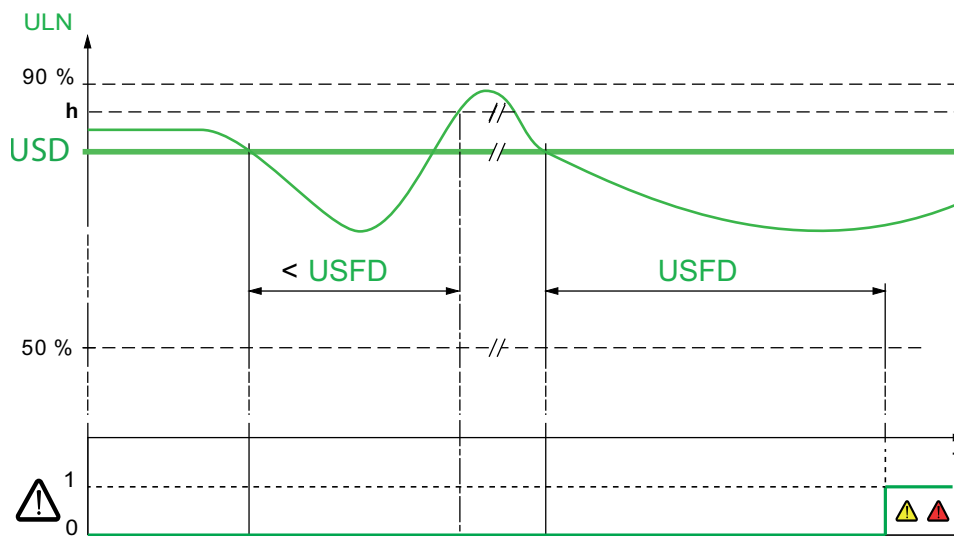

Legend:

- **h**: the timer **[UV Detection Delay]** is reset to zero if the voltage exceeds 105 % of **[Undervoltage Thld]**.
- : **[UnderV Warn]**
- : **[Supply Mains UnderV]**

HMI label	Setting	Factory setting
[Undervoltage Thld] <i>USD</i>	50...90% of <i>Mains voltage</i> <i>ULN</i>	85%
Undervoltage threshold		
This parameter is used to set the mains voltage threshold value for triggering a [Supply Mains UnderV] <i>USF</i> error.		
[UV Detection Delay] <i>USFD</i>	1...60 s	5 s
Undervoltage detection delay		
This parameter is used to set the time delay to trigger a [Supply Mains UnderV] <i>USF</i> error. when the [Undervoltage Thld] is reached.		
The timer [UV Detection Delay] is reset to zero if the voltage exceeds 105 % of [Undervoltage Thld] .		
[Voltage Error Resp] <i>MVFB</i>	–	[Ignore]
Response to an under/overvoltage error		
This parameter sets the soft starter behavior when the mains voltage is below the threshold set in [Undervoltage Thld] for a duration longer than the value set in [UV Detection Delay] .		
<ul style="list-style-type: none"> • [Ignore]: Trigger [UnderV Warn] <i>USA</i>. The warning should be assigned to a warning group in [Warn groups config] to be visible when triggered. Refer to <i>Warning Messages</i>, page 289. • [Freewheel Stop]: Error [Supply Mains UnderV] <i>USF</i> is triggered and motor stops in freewheel. • [Configured Stop]: Motor stops according to the value set in [Type of stop], [UnderV Warn] is triggered. • [Deceleration]: Motor stops in deceleration and an error [Supply Mains UnderV] <i>USF</i> is triggered at the end of deceleration. • [Braking]: Motor stops in dynamic braking stop and an error [Supply Mains UnderV] <i>USF</i> is triggered at the end of stop. 		

Unbalanced Voltage & Unbalanced Current

Unbalanced Voltage

Access path: **[Monitoring]** → **[Unbalance]**

HMI label	Setting	Factory setting
[Volt Unbalance Thld] MVUT	5...10.00% of [Mains Voltage]	5%
<p>Mains unbalance threshold This parameter is used to set the mains unbalance threshold value.</p> <p>If the [Mains Unbalance Ratio] UMV exceeds the threshold set in [Volt Unbalance Thld], a warning [Volt Unbalance Warn] ULBA is triggered.</p>		

Unbalanced Current

Access path: **[Monitoring]** → **[Unbalance]**

HMI label	Setting	Factory setting
[Curr Unbalance Thld] CURT	5...60.00% or [No] NO	[No]
<p>Current unbalance alarm threshold This parameter is used to set the current unbalance threshold value.</p> <p>The current unbalance ratio [Current Unbalance] defined by <i>Negative sequence current Magnitude</i> / <i>(Positive sequence current magnitude)*100</i>, is compared to the threshold [Curr Unbalance Thld] to trigger a warning [Curr Unbal Warn] ILBA, if threshold is exceeded for the duration of [Curr Unbalance Delay].</p>		
[Curr Unbalance Delay] CURD	1...60s	10s
<p>Current unbalance alarm Delay This parameter is used to set the time delay to trigger a warning [Curr Unbal Warn] ILBA when the [Curr Unbalance Thld] is exceeded.</p>		

Mains Frequency

Access path: **[Monitoring]** → **[Mains Frequency]**

HMI label	Setting	Factory setting
[Frequency Diag] FRDA	–	[At Run Order] RUN
<p>Line Frequency Diagnostic activation</p> <ul style="list-style-type: none"> [At Run Order]: The frequency diagnostics is executed at run order. [Freq Diag Activation]: The frequency diagnostics is executed permanently. 		

HMI label	Setting	Factory setting
[Mains Frequency] <i>FRC</i>	–	[Auto] <i>AUTO</i>
<p>Mains frequency</p> <p>Set the expected mains frequency.</p> <ul style="list-style-type: none"> • [Auto]: Automatic recognition of the mains frequency, tolerance of 5% • [50Hz]: Expected frequency at 50 Hz, tolerance of 20% • [60Hz]: Expected frequency at 60 Hz, tolerance of 20% • [Custom]: Frequency tolerance value in Hz, between [Low Frequency] and [High Frequency]. <p>If the mains frequency goes out of the tolerance of the expected frequency, soft starter will react according to [Freq Error Resp] configuration.</p>		
[Freq Error Resp] <i>FRFB</i>	–	[Freewheel Stop] <i>YES</i>
<p>Response to a line frequency error</p> <ul style="list-style-type: none"> • [Ignore]: Trigger [Mains Freq Warn] FRQA. The warning should be assigned to a warning group in [Warn groups config] to be visible when triggered. Refer to <i>Warning Messages</i>, page 289. • [Freewheel Stop]: Error [Mains Freq Error] FRF is triggered and motor stops in freewheel. • [Deceleration]: Motor stops in deceleration and an error [Mains Freq Error] FRF is triggered at the end of deceleration. • [Braking]: Motor stops in dynamic braking stop and an error [Mains Freq Error] FRF is triggered at the end of stop. 		
[Low Frequency] <i>FRTL</i>	40...60 Hz	47 Hz
<p>Frequency Range Low value</p> <p>Set the minimum mains frequency tolerance.</p> <p>This parameter is visible only if [Mains Frequency] is set to [Custom].</p>		
[High Frequency] <i>FRTH</i>	50...75 Hz	63 Hz
<p>Frequency Range High value</p> <p>Set the maximum mains frequency tolerance.</p> <p>This parameter is visible only if [Mains Frequency] is set to [Custom].</p> <p>[High Frequency] value must be higher than [Low Frequency] value +10.</p>		

Motor External Thermal Sensor

A thermal sensor fixed on a motor can be connected on the soft starter. By enabling this capability, the soft starter measures the temperature of the motor according to the sensor type and connection.

The menu **[Thermal monitoring]** provides the parameters to measure a temperature with a thermal sensor wired of the PTC1/AI1 terminal (cabinet, a room, etc...).

PTC, PT100, PT1000 and KTY thermal sensors are supported by this function.

The function gives the possibility to manage 2 types of monitoring:

- the soft starter triggers a warning without stopping the application (except for PTC sensors).
- the soft starter triggers an error and stops the application.

The monitoring function takes into account the following events:

- Overheating
- Sensor break (loss of signal)
- Sensor short-circuit

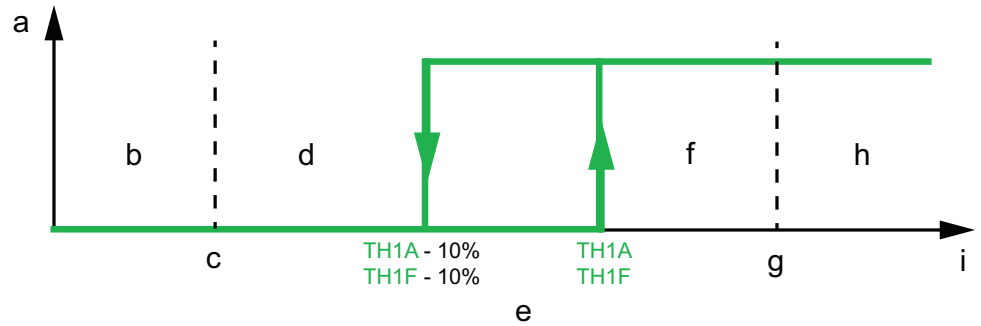

- (a): Thermal sensor state.
- (b): Short circuit.
- (c): Short circuit level.
- (d): Cold.
- (e): Hysteresis.
- (f): Hot
- (g): Open circuit level.
- (h): Open circuit.
- (i): Thermal sensor value.

NOTE: **[Thermal monitoring]** does not deactivate the motor thermal monitoring provided by the calculation. Both types of monitoring can operate in parallel.

Type of Thermal Sensor Selection

If the length between the motor and the soft starter is high, prefer a connection PT100 or PT1000 with 3 wires for a better accuracy.

PTC thermal sensors are adapted for an overheating detection. PT100, PT1000 and KTY thermal sensors allow to monitor in real-time the temperature of the motor.

For 2-Wire Sensors

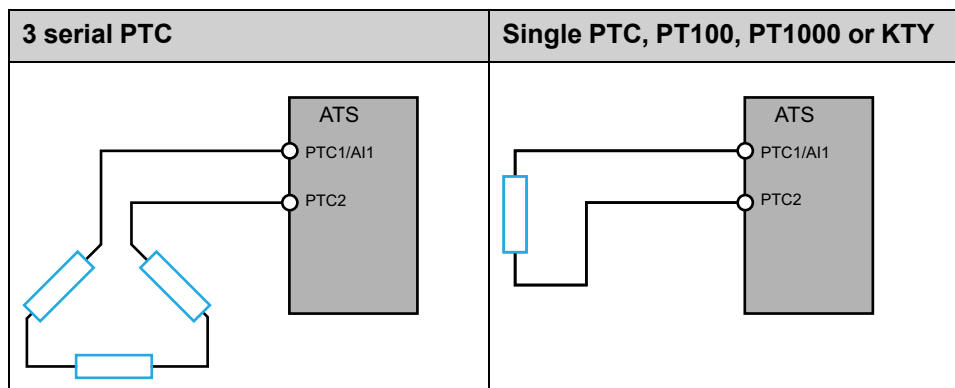

For 3-Wire Sensors

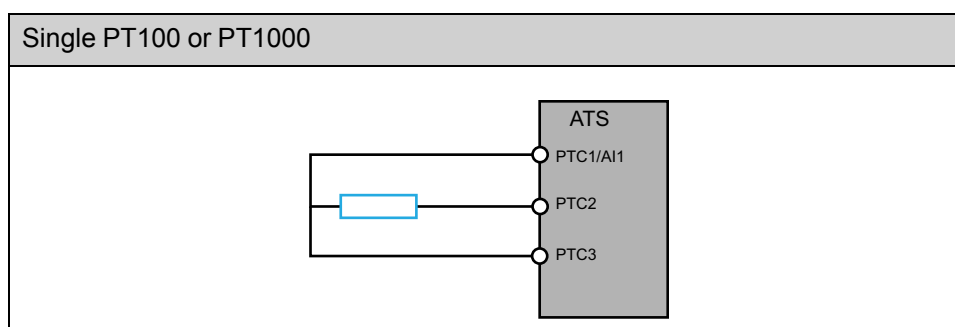

Access path: [Monitoring] → [Thermal monitoring]



HMI label	Setting	Factory setting
[AI1 Th Monitoring] TH1S	–	[Not Configured] NO
<p>Activation of the thermal monitoring on AI1</p> <p>This parameter enables the thermal sensor monitoring from thermal sensors on the terminal PTC1/AI1.</p> <ul style="list-style-type: none"> • [Not Configured]: Disable thermal monitoring on PTC1/AI1. • [AI1]: Enable thermal monitoring on PTC1/AI1 and trigger an error or warning on detection 		
[AI1 Type] AI1T	–	[Not Configured] NO
<p>Configuration of AI1</p> <p>This parameter sets the type of thermal sensors wired to the terminal PTC1/AI1.</p> <ul style="list-style-type: none"> • [Not Configured]: Not configured, to use only as temporary value before assigning another type on analog input • [PTC]: 1 to 6 PTC in serial is used. • [KTY]: 1 KTY connected with 2 wires is used. • [PT1000]: 1 PT1000 connected with 2 wires is used. • [PT100]: 1 PT100 connected with 2 wires is used. • [PT1000 in 3 wires]: 1 PT1000 connected with 3 wires is used. • [PT100 in 3 wires]: 1 PT100 connected with 3 wires is used. <p>This parameter can be accessed if [AI1 Th Monitoring] is set to [AI1].</p> <p>Thermal sensor wiring has to be done before [AI1 Type] configuration, to prevent an error from triggering.</p>		

HMI label	Setting	Factory setting
[AI1 Th Error Resp] TH1B	–	[Freewheel Stop] YES
<p>Response to thermal error for AI1</p> <p>This parameter sets the behavior of the soft starter when the threshold set in [AI1 Th Error Level] is reached on the terminal PTC1 / AI1.</p> <ul style="list-style-type: none"> • [Ignore]: Trigger [AI1 Th Warning] TP1A or [Temp Sens AI1 Warn] TS1A. The warning should be assigned to a warning group in [Warn groups config] to be visible when triggered. Refer to Warning Messages, page 289. • [Freewheel Stop]: Error [AI1 Th Level Error] TH1F is triggered and motor stops in freewheel. • [Configured Stop]: Motor stops according to the value set in [Type of stop], [AI1 Th Warning] TP1A or [Temp Sens AI1 Warn] TS1A is triggered. • [Deceleration]: Motor stops in deceleration and an error [AI1 Th Level Error] TH1F is triggered at the end of deceleration. • [Braking]: Motor stops in dynamic braking stop and an error [AI1 Th Level Error] TH1F is triggered at the end of stop. 		
[Temperature unit] SUTP	[0.1°C] or [0.1°F]	[0.1°C]
<p>Application Temperature Unit (used as default)</p>		
[AI1 Th Error Level] TH1F	Range: –15.0...200.0°C Unit: selected by [Temperature unit] SUTP.	110.0°C
<p>Thermal error level for AI1</p> <p>This parameter sets the threshold for triggering the [AI1 Th Level Error] when [AI1 Th Monitoring] is set to [AI1].</p> <p>The [AI1 Th Level Error] can be reset at [AI1 Th Error Level] – 10%, refer to the curve at the beginning of this chapter.</p> <p>This parameter can be accessed if the setting of [AI1 Type] is different than [PTC].</p>		
[AI1 Th Warn Level] TH1A	Range: –15.0...200.0°C Unit: selected by [Temperature unit] SUTP.	90.0°C
<p>Thermal warning level for AI1</p> <p>This parameter sets the threshold for triggering a warning when [AI1 Th Monitoring] is set to [AI1].</p> <p>The warning will trigger at the set temperature only if [AI1 Th Warning] is set to a warning group in [Diagnostics] → [Warnings].</p> <p>This parameter can be accessed if the setting of [AI1 Type] is different than [PTC].</p> <p>The warning is reset at [AI1 Th Warn Level] – 10%, refer to the curve at the beginning of this chapter.</p>		
[AI1 Th Value] TH1V	Range: –15...200°C Unit: selected by [Temperature unit] SUTP.	–
<p>AI1 thermal value</p> <p>This parameter displays the current temperature measurement by the wired thermal sensors.</p> <p>In case of short circuit with the thermal sensor, the displayed value will be –35°C (-31°F) (86,19 Ohm).</p> <p>In case of open circuit with the thermal sensor, the displayed value will be 206.6°C (404°F) (177,68 Ohm).</p> <p>This parameter can be accessed if the setting of [AI1 Type] is different than [PTC].</p>		

HMI label	Setting	Factory setting
[AI1 filter] 	0...10 s	0 s
<p>AI1 filter</p> <p>This parameter set the cutoff time of the low pass filter for PTC1/AI1.</p> <p>The low pass filter aims to suppress electric noise of the thermal sensor and avoid interference issue in the input signal.</p> <p>This parameter can be accessed if [AI1 Th Monitoring] is set to [AI1].</p>		

Gamma Sync

Access path: [Monitoring]

HMI label	Setting	Factory setting
[Gamma Sync Enable] 	[Yes] or [No]	[Yes]
<p>Gamma synchronization Equilibrium Activation</p> <p>This parameter enables the detection of a balance in each phase current conduction.</p> <ul style="list-style-type: none"> [Yes] : desynchronization detection enabled. In case of a desynchronization detected, the error [SCR Sync Error]  is triggered. [No] : desynchronization detection disabled. 		

Other Settings

What's in This Chapter

Set The Mains Voltage.....	150
Set Motor Nameplate Parameters.....	151
Set Second Current Limitation.....	153
Mains Contactor Command	155

These parameters allow access to other settings for fine-tuning.

To access to this menu, the **[Access Level]** needs to be set to **[Standard]** or to **[Expert]**.

Set The Mains Voltage

Mains Voltage is used as an input for several monitoring functions as Overvoltage, Undervoltage and many other functions.

The estimated mains voltage and motor power can be consulted in **[Display]** → **[Motor parameters]**.

[Complete settings] → **[Motor parameters]**

Description	Setting range	Factory setting
[Mains Voltage] <small>ULN</small>	170...760 V (1)	400 V
<p>Mains voltage of the soft starter.</p> <p>(1) If [Inside Delta] is set to [Yes], the setting range is 170...500 V.</p>		

Set Motor Nameplate Parameters

Adjust the values of these parameters according to the motor nameplate. These parameters allow to improve torque estimation (for monitoring and control), to monitor mechanical speed in steady state and mechanical power (this can not be estimated if motor nameplate is not fulfilled).

The complete settings of all motor parameters are not mandatory to run the soft starter, only **[Motor Nom Current]** is mandatory.

[Nameplate Mismatch] warning is triggered if when the entered nameplate values are not coherent with each other, or the values are too high for the product size concerned.

The factory setting of **[Nom Motor Voltage]**, **[Nominal Motor Freq]**, **[Nominal Motor Spd]** and **[Nominal Motor Power]** is **[Same As Mains]**. In this case, the values are based on measured grid voltage, frequency and default **[Power Factor]**.

Access path: **[Complete settings] → [Motor parameters]**

HMI label	Setting	Factory setting
[Motor Nom Current] <i>IN</i>	—	(1)
<p>Nominal current</p> <p>Adjust the value of [Motor Nom Current] according to the rated motor current indicated on the motor nameplate even if the soft starter is wired in the motor delta.</p> <p>[Motor Nom Current] has two ranges of values:</p> <ul style="list-style-type: none"> • 0.4...1 of soft starter rating (I_e, rated operational current) if [Inside Delta] is set to [No]. If the rated motor current is below 0.4 I_e, use a lower rated soft starter. • 0.69...1.73 of I_e if [Inside Delta] is set to [Yes]. <p>For more information about [Inside Delta] refer to <i>Connection Inside the Delta Of The Motor</i>, page 156.</p> <p>(1) Factory setting of [Motor Nom Current] corresponding to the usual value of a 4-pole 400 V standardized induction motor and [Inside Delta] is set to [No] (soft starter connected in-line).</p> <p>The unit of the product display depends on the product size.</p> <ul style="list-style-type: none"> • For sizes smaller than ATS490C25Y, the unit is 0.1 A. • For ATS490C25Y and up, the unit is 1 A. 		
[Nom Motor Voltage] <i>UNS</i>	[Same As Mains] ; 200...710 V	[Same As Mains] <i>AUTO</i>
<p>Nominal motor voltage</p> <p>If [Inside Delta] is set to [Yes], the setting range is : [Same As Mains]; 200...500 V.</p> <p>[Voltage Inconsistent] warning is triggered If the difference between [Nom Motor Voltage] and [Mains Voltage] is higher than 100 V. The warning should be assigned to a warning group in [Warn groups config] to be visible when triggered. Refer to <i>Warning Messages</i>, page 289.</p>		
[Nominal Motor Freq] <i>FRS</i>	[Same As Mains] ; 35...75 Hz	[Same As Mains] <i>AUTO</i>
<p>Nominal motor frequency</p>		
[Nominal Motor Spd] <i>NSP</i>	[Same As Mains] ; 33...4500 rpm	[Same As Mains] <i>AUTO</i>
<p>Nominal motor speed</p>		
[Motor Power unit] <i>MPUT</i>	[Kilo Watts] or [Horse Power]	[Kilo Watts] <i>KW</i>
<p>Motor Power unit type</p> <ul style="list-style-type: none"> • [Kilo Watts] : Motor power unit in Kilo Watts • [Horse Power] : Motor power unit in Horse Power 		
[Nominal Motor Power] <i>NPR</i>	—	[Same As Mains] <i>AUTO</i>
<p>Nominal motor power</p> <p>[Nominal Motor Power] depends on [NPR power scaling] (<i>NPR power scaling</i> accessible via communication).</p> <p>The setting range depends on the soft starter rating (I_e, rated operational current) :</p> <ul style="list-style-type: none"> • Min value : 70*I_e • Max value : 1840*I_e <p>The unit of the product displayed depends on the product size and [Motor Power unit].</p> <ul style="list-style-type: none"> • For ATS490C25Y and smaller sizes, the unit is 0.1 Kw or 0.1 HP. • For sizes bigger than ATS490C25Y, the unit is 1 Kw or 1 HP. 		

Set Second Current Limitation

These parameters allow to switch between 2 current limitations defined by **[Current Limit]** and **[Ext Current Limit]** using a digital or a virtual input defined by **[Ext Curr Lim Assign]**.

This function is not compatible with **[2nd Mot Param Set]**.

Access path: **[Complete settings] → [Motor parameters]**

HMI label	Setting	Factory setting
[Current Limit] <i>ILT</i>	150...700%	400% of [Motor Nom Current] <i>IN</i>
Motor limiting current		
Refer to Set the Current & Current Limitation, page 122.		
[Ext Current Limit] <i>ILX</i>	150...700%	400% of [Motor Nom Current] <i>IN</i>

External current limitation level (% of Motor Nominal Current)

The RMS motor line current will be limited to **[Ext Current Limit]** multiplied by **[Motor Nom Current]**.

[Ext Current Limit] max setting is limited to:

- in-line connection: $500\% \times I_e / I_N$
- inside delta connection: $500\% \times \sqrt{3} \times I_e / (I_N)$

In any case the **[Ext Current Limit]** max setting will not exceed 700% of nominal motor line current.

If **[Inside Delta]** is set to **[Yes]**, the factory setting is 700% of **[Motor Nom Current]**.

The current limit setting is always active during start up and overrides all other settings.

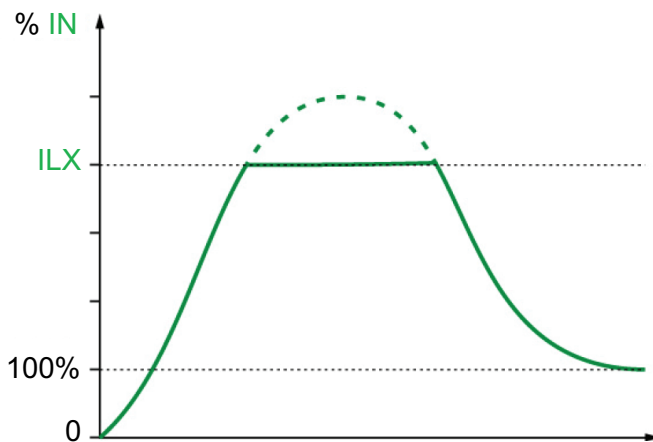

Example 1 in-line connection:

ATS490C21Y, with $I_e = 210$ A

[Motor Nom Current] = 195 A

[Ext Current Limit] = 500% (under max setting : $500\% \times I_e / I_N = 5 \times 210 / 195 = 538\%$)

External current limitation = $500\% \times 195 = 975$ A

Example 2 inside delta connection:

ATS490C21Y, with $I_e = 210$ A

[Motor Nom Current] = 338 A

[Ext Current Limit] = 500% (under max setting : $500\% \times I_e / (I_N / \sqrt{3}) = 5 \times 210 / (338 / \sqrt{3}) = 538\%$)

External current limitation = $500\% \times 338 = 1690$ A

[Ext Curr Lim Assign] <i>ILXA</i>	—	[Not Assigned] <i>NO</i>
<p>External current limitation activation</p> <p>This parameter sets a digital input, or a virtual input via CMD word, bits 11 to 15 (Refer to the fieldbus manuals for the CMD word assignments), to switch between 2 current limitations.</p> <p>At low level of the assignation (or set to [Not Assigned]), [Current Limit] is used. At high level of the assignation, [Ext Current Limit] is used.</p> <ul style="list-style-type: none"> • [Not Assigned]: No input assigned. • [DI●]: current limitation switching is assigned to digital input DI●. • [CD●●]: current limitation switching is assigned to line channel. 		

Mains Contactor Command

This menu provides the parameters to manage a line contactor upstream the soft starter. Refer to complete diagram.

Access path: **[Complete settings] → [Mains contactor cmd]**

HMI label	Setting	Factory setting
[Mains Contactor] LLC	[Not Assigned] NO, [R1] , [R2] or [R3]	[Not Assigned] NO

Mains contactor control

This parameter sets the external mains supply contactor command. The soft starter can command an external contactor placed upstream in the main supply via the relay R1, R2 or R3, allowing to close or open the mains supply of the soft starter with a relay command.

If the function **[Mains Contactor]** LLC is set to R1, a factory settings will reset R1 to **[Operating State Fault]** and could apply, depending on the wiring diagram, voltage on the mains supply inputs via the mains contactor.

DANGER

UNINTENDED PRESENCE OF VOLTAGE ON THE MAINS SUPPLY INPUTS

- Verify that restoring to factory setting when **[Mains Contactor]** LLC is set to R1 does not result in unsafe conditions.
- In case of doubt, prefer to set the parameter **[Mains Contactor]** LLC to another relay output.

Failure to follow these instructions will result in death or serious injury.

The relay command is based on the Run / Stop commands and the detected errors:

- The external contactor command is activated by a Run, Jog, Reverse, Anti-Jam or Pre-heating command
- The mains contactor output is deactivated:
 - At the end of a braking, deceleration or when the motor switches to freewheel after a Stop command.
 - When an error is detected.

NOTE: when line contactor is configured, the run command is considered in **NLP** state.

[Device Lock] LES	–	[Not Assigned] NO
--------------------------	---	--------------------------

Device lock assignment

This parameter sets a digital input, or a virtual input via the CMD word, to lock the device. When this input is activated (Low level on digital inputs, high level on virtual inputs), the relay assigned to **[Mains Contactor]** is forced to open, which opens the mains contactor and stops the motor in freewheel.

To restart the motor, deactivate the digital input command and apply a new Run order.

- [Not Assigned]**: No input assigned.
- [DI• (Low level)]** : Digital input DI• low level assigned.
- [CD••]** : Assigned to line channel.

This parameter can be accessed if **[Mains Contactor]** is set to **[R1]**, **[R2]** or **[R3]**. **[Device Lock]** does not affect the emergency stop switch.

[Mains V. time out] LCT	1...999 s	5 s
--------------------------------	-----------	-----

Mains V. time out

This parameter sets the time before triggering the error:

- [Input Contactor]** LCF if the soft starter does not detect the mains after mains contactor activation.
- [Input Contact. Closed]** LCCF if the soft starter detects the mains after mains contactor deactivation.

NOTE: If mains contactor relay is closed at power on, error **[Input Contact. Closed]** LCCF is not managed, soft starter can be in **RDY** state.

Inside the Delta of the Motor

What's in This Chapter

Connection Inside the Delta Of The Motor 156
 Diagnostic of the Delta Connection 157

Connection Inside the Delta Of The Motor

This function enables the soft starter connection in the motor delta winding.

For the diagrams to wire the soft starter inside the delta of the motor, refer to Connection In line and Inside Delta, page 22 and Application diagrams, page 37.

Access path: **[Complete settings] → [Motor wiring]**

Step	Action
1	Set [Inside Delta] to [Yes] . The soft starter can now operate inside the motor delta windings.
2	Enabling the connection in the Delta : <ul style="list-style-type: none"> • can modify the settings of the parameters in the menu [Simply Start] → [Simply start]. • can modify the settings of the parameters in the menu [Complete settings] → [Motor parameters]. • will reset the value set on [Stator Loss Comp]. Verify that the parameter settings in this menu are adequate with the use of the soft starter inside the motor delta windings.
3	After validating the settings in the menu [Simply Start] → [Simply start] , send a Run order to start the motor.

NOTE:

- To stop the motor, send a Stop order. The motor will stop following the setting of **[Type of stop]**.
- An integrated diagnostic is available to verify the correct wiring of the soft starter in the motor delta winding. For more information about how to use this diagnostic, refer to Diagnostic Of The Delta Connection, page 157.

For the complete list of incompatibilities, refer to Functions Compatibility Table, page 195.

HMI label	Setting	Factory setting
[Inside Delta] <i>DLT</i>	[No] or [Yes]	[No]
Starter with delta winding in series connection		
NOTICE		
DESTRUCTION OF THYRISTOR		
Only set the parameter [Inside Delta] to [Yes] if the mains voltage does not exceed 500 Vac. Failure to follow these instructions can result in equipment damage.		
The safety function STO is not compatible with [Inside Delta] <i>DLT</i> function. If the safety function STO is enabled while [Inside Delta] <i>DLT</i> function is set to [Yes], the soft starter will trigger the [STO On Inside Delta] <i>DLTF</i> error.		
⚠ WARNING		
INEFFECTIVE SAFETY FUNCTION		
<ul style="list-style-type: none"> Never use the safety function STO when the function [Inside Delta] <i>DLT</i> is activated. Always consider that enabling the safety function STO when the [Inside Delta] <i>DLT</i> function is set to [Yes] does not provide any Safety Integrity Level (SIL), Performance Level (PL), or any other capacity related to the safety of your machine or process. Failure to follow these instructions can result in death, serious injury, or equipment damage.		
<ul style="list-style-type: none"> [No]: soft starter connected “in-line” mode. [Yes] : soft starter connected “delta-inside” mode. 		
The parameter [Inside Delta] must be set to [Yes] before the settings of the parameters available in the menu [Simply Start] → [Simply start], otherwise they could be modified and set back to their default values.		

Diagnostic of the Delta Connection

This function offers a diagnostic procedure to verify the correct wiring of the soft starter in the motor delta winding.

This procedure must be applied without a load.

The corrections proposed by the diagnostic does not ensure that the motor will start in the correct direction.

For the diagrams to wire the soft starter inside the delta of the motor, refer to Connection In line and Inside Delta, page 22 and Application Diagrams, page 37.

This function requires [Inside Delta] to be set to [Yes].

Access path: [Complete settings] → [Motor wiring]

⚠⚠ DANGER

HAZARD OF ELECTRIC SHOCK, EXPLOSION, OR ARC FLASH

Before any modification of the wiring on the equipment:

- Use all required personal protective equipment (PPE).
- Disconnect all power, including external control power that may be present. Take into account that the circuit breaker or main switch does not de-energize all circuits.
- Verify the absence of voltage using a properly rated voltage sensing device.

Failure to follow these instructions will result in death or serious injury.

Step	Action
1	Set [In Delta Diag] to [Yes] . Result: It starts the delta inside wiring diagnostic, mains supply must be present and no current is injected into the motor.
2	Refer to the [In Delta Diag Status] table below to perform the required actions. The corrections listed by [In Delta Diag Status] does not ensure that the motor will start in the correct direction.
3	When the diagnostic is done, [In Delta Diag] is forced back to [No] . To start a new diagnostic after performing an action on the delta wiring, set [In Delta Diag] back to [Yes] .
4	When [In Delta Diag Status] displays the status [Passed] , check the rotation direction of the motor by applying a Run order to start the motor without load. If the rotation direction is not correct, invert 2 phases on the input of the Supply mains.
5	When the rotation direction has been checked, the motor can be start and stop with its load.

Diagnostic result:

[In Delta Diag Status] DLTS	Definition
[Not Done] NA	Diagnostic not done.
[Passed] OK	Diagnostic successfully passed, ready to start
[Pending] PEND	Mains supply not detected by the soft starter. Verify the presence of the mains supply on the power parts of the soft starter: 1/L1, 3/L2 and 5/L2.
[Invert L2 & L3] 32	Invert phase 2 and 3
[Invert L1 & L2] 21	Invert phase 1 and 2
[Invert L1 & L3] 31	Invert phase 1 and 3
[Change 123 to 312] 312	Do a circular permutation, phase 1 on 2, phase 2 on 3, phase 3 on 1.
[Change 123 to 231] 231	Do a circular permutation, phase 1 on 3, phase 3 on 2, phase 2 on 1.
[Bad Motor Wiring] MOT	Check motor coupling and windings.
[Unknown Error] UNK	Unknown error (missing wire, 2 phases on the same motor phase, motor in line)
[Input Phase Loss] GRID	1 or 2 phases are lost on mains side. Check mains coupling and winding.

The listed corrections do not ensure that the motor will start in the correct direction.

The corrections listed by **[In Delta Diag Status]** must be applied between the motor terminals (point “c” on the diagram below) and the supply mains upstream the soft starter (point “a”).

Example: [In Delta Diag Status] = [Invert L2 & L3]:

Before correction:

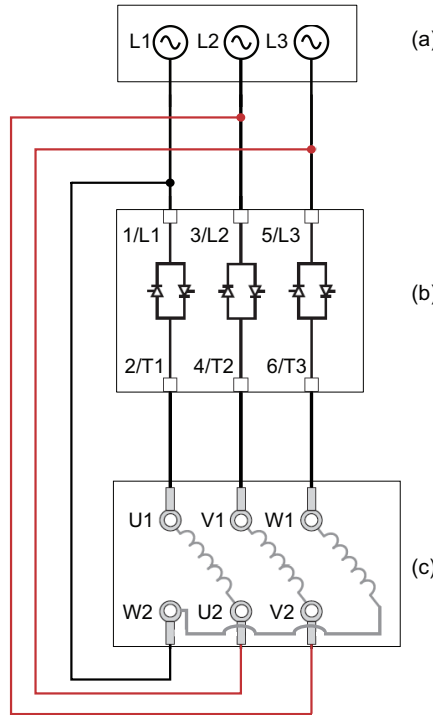

After correction:

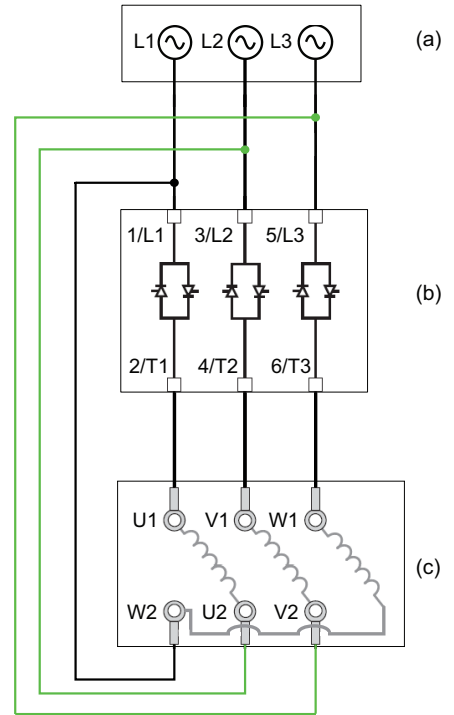

- (a): Supply mains
- (b): Soft starter
- (c): Motor terminals

To go further

Access path: **[Complete settings] → [Motor wiring]**

HMI label	Setting	Factory setting
[In Delta Diag] <small>DLTL</small>	—	[No]
<p>Inside Delta diagnostics</p> <ul style="list-style-type: none"> • [No]: no delta inside diagnostic. • [Yes]: start delta inside wiring diagnostic. <p>[In Delta Diag] is forced back to [No] after a diagnostic. To start another diagnostic set it back to [Yes]. The diagnostic result is available in [In Delta Diag Status].</p> <p>This parameter is visible if [Inside Delta] is set to [Yes].</p>		

Small Motor Test

This function can be used to validate the wiring of the soft starter by rotating a small motor that is a fraction of the soft starter rating.

The following table gives the minimum motor power required for the small motor function depending on the soft starter reference. The small motor function is not guaranteed to operate correctly if these minimum ratings are not followed :

Mains supply (Vac)	Minimum motor power			
	For ATS490-D17...C17Y	For ATS490C21Y	For ATS490-C25...C41Y	For ATS490-C48...M12Y
208	2,2kW	5,5kW	7,5kW	5,5kW
230	3kW	7,5kW	9kW	7,5kW
380	4kW	11kW	15kW	11kW
400	4kW	15kW	15kW	15kW
440	5,5kW	15kW	15kW	15kW
500	5,5kW	15kW	18,5kW	15kW
600	7,5kW	18,5kW	22kW	18,5kW
690	7,5kW	18,5kW	22kW	18,5kW

NOTE:

When **[Small Motor Test]** is set to **[Yes]**:

- **[Phase Loss Monit]** is set to **[No]** , phase loss monitoring is disabled.
- **[Control Mode]** parameter is forced to **[Voltage Control]**.

⚠ WARNING

TEMPORARY MODIFICATION OF THE BEHAVIOR

- Only use this function for test and maintenance purposes.
- Verify that disabling phase loss detection does not result in unsafe conditions.

Failure to follow these instructions can result in death, serious injury, or equipment damage.

NOTE: The **[Small Motor Test]** test function is set to **[No]** when the soft starter control supply is disconnected. Upon next power-up the soft starter, including **[Phase Loss Monit]** and **[Control Mode]**, will return to its previous configuration.

Step	Action
1	Wire a small motor, refer to the ratings table above.
2	Set [Small Motor Test] to [Yes] .
3	To start the test, apply a Run command to the soft starter by pressing the RUN button on the display terminal ([HMI] as command channel) or via the STOP and RUN control terminals ([Terminal] as command channel).
4	To stop the test, apply a Stop command to the soft starter by pressing the STOP / RESET button on the display terminal or via the STOP and RUN control terminals.

Description	Setting range	Factory setting
[Small Motor Test] <i>SST</i>	—	[No]
<p>Small motor test</p> <p>Access path: [Complete settings] → [Motor wiring]</p> <ul style="list-style-type: none"> • [Yes]: Ready to start the test, apply a Run command • [No]: Function inactive, the soft starter will start normally when a Run command is applied <p>During the test, the display terminal displays the state [Small Motor Test] instead of the [Ready] state.</p> <p>When [Small Motor Test] is set to [Yes]:</p> <ul style="list-style-type: none"> • [Phase Loss Monit] is set to [No] , phase loss monitoring is disabled. • [Control Mode] parameter is forced to [Voltage Control]. 		

Particular case : Test the power connection with small motor test in “Initial setup” :

Step	Action
1	Wire the mains and the motor side on the soft starter and supply in 208.690 Vac, following the small motor supply voltage.
2	In the [Initial Setup] menu, scroll to [Small Motor Test] and press OK . Result: An instruction message is displayed on the display terminal.
3	Give a Run command to check the motor behavior. Give a Stop order to stop the motor.
4	To leave the [Small Motor Test] function, turn Off and Turn On the device control supply or press ESC . Result: The [Initial Setup] is displayed.

Torque / Voltage Control

The start and controlled stop profiles follow a motor control algorithm, active either on a torque profile or on a voltage profile. This function can be used to choose torque or voltage profile to control the motor start and stop.

Torque control is specified for pumps, fans with belts, circular saws and limits:

- Jerk when the motor starts
- Hammering effect
- Sliding effect

Voltage control is specified for motors in parallel on one soft starter.

With torque control, the start and stop of the motor can be set via the **[Simply Start]** menu, for more information refer to *Simply Start*, page 119.

With voltage control, the start and stop of the motor can be set via the **[Simply Start]** menu and the parameter **[Init Starting Voltage]** must be considered, for more information refer to *Voltage Boost*, page 177.

Access path: **[Complete settings] → [Start & Stop]**

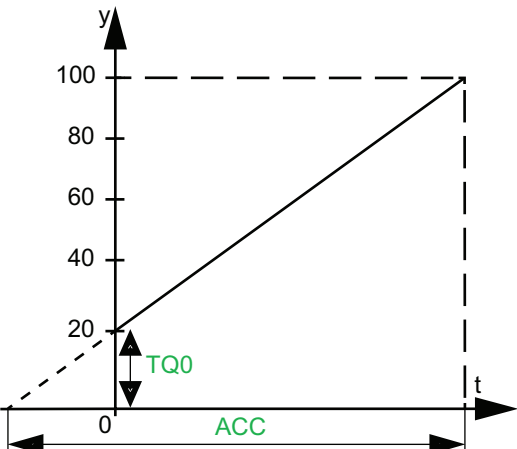
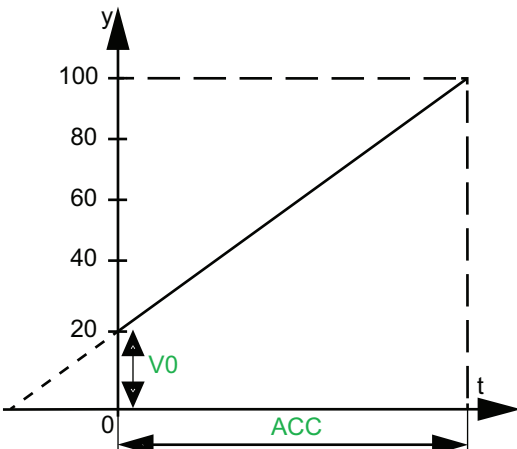
Description	Setting range	Factory setting
[Control Mode] CLP	[Torque Control] TC or [Voltage Control] VC	[Torque Control] TC
Control mode		
<ul style="list-style-type: none"> • [Torque Control]: Activate torque control. • [Voltage Control]: Activate voltage control. 		
Acceleration with torque control:  <ul style="list-style-type: none"> • y: Reference torque as % of nominal torque • t: Time (s) • TQ0: <i>Initial starting torque</i> • ACC: <i>Acceleration ramp time</i> <p>More information about <i>Initial starting torque</i> and <i>Acceleration ramp time</i> in <i>Set Start Profile</i>, page 124.</p>	Acceleration with voltage control:  <ul style="list-style-type: none"> • y: Reference voltage as % of nominal voltage • t: Time (s) • V0: <i>Initial starting voltage</i> • ACC: <i>Acceleration ramp time</i> 	

[Init Starting Voltage] V0	25%...49% of [Mains Voltage] ULN	49%
<p>Initial starting voltage</p> <p>Set [Init Starting Voltage] level between 25% and 49% of [Mains Voltage]. The set value must be high enough to create a torque superior to the resistive torque.</p> <p>This parameter is visible if [Control Mode] is set to [Voltage Control].</p> <p>The function [Boost] can be used to provide a boost at the start to overcome a mechanical hard point. More information about Voltage boost level in Voltage Boost, page 177</p>		

Start and Stop

Start profile (Set Start Profile, page 124) and Stop profile (Set Stop Profile, page 125) are set in the **[Simply start]** menu. Additional features like **Threshold for changing to freewheel stop in voltage control**, **Torque control deceleration gain**, **Torque limit** and **Stator loss compensation** can be set :

Acceleration

Description	Setting range	Factory setting
[Acceleration] ACC	1...180 s	15 s
<p>Acceleration ramp time</p> <p>When [Control Mode] is set to [Torque Control] (factory setting), this parameter sets the ramp time from no torque to nominal torque.</p> <p>When the motor reaches established regime, the soft starter state change to [Bypassed] BYP, even if the motor reaches established regime before the value set to [Acceleration].</p> <p>The initial starting torque depends on the parameter [Init Starting Torque].</p> <p>When [Control Mode] is set to [Voltage Control], the value set to this parameter is the time of the voltage ramp from the initial voltage to the established mains voltage, if the parameter [Motor Nom Current] doesn't limit the starting current.</p> <p>The initial voltage of the ramp is set by the parameters [Boost] and [Init Starting Voltage].</p> <p>For more information refer to Torque / Voltage Control, page 162.</p> <p>For more information about [Boost], refer to Voltage Boost, page 177.</p>		
[Init Starting Torque] TQ0	0...100% of nominal torque	20%
<p>Initial starting torque</p> <p>Initial torque setting during the starting phase. If set too low, the motor may not start as soon as the RUN command is applied.</p> <p>[Init Starting Torque] cannot be higher than [Torque Limit].</p> <p>For more information refer to Set Start Profile, page 124.</p>		

Deceleration

Description	Setting range	Factory setting
[Deceleration] <i>DEC</i>	1...180 s	15 s

Deceleration ramp time

If **[Control Mode]** is set to **[Torque Control]** (factory setting), this parameter sets the deceleration ramp time from the estimated applied torque at Stop order to no torque applied.

Example with 80% of the nominal torque when a Stop order is applied:

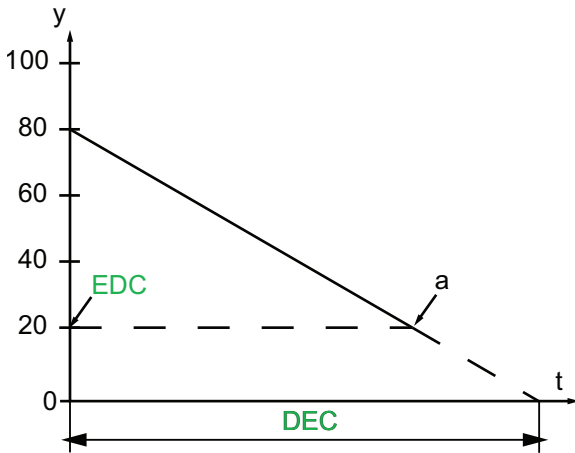

- y: Estimated torque (as a percentage of the nominal torque).
- a: End of controlled deceleration set by *EDC*, motor stops in freewheel. More information on **End of controled deceleration threshold** available in Set Stop Profile, page 125.
- t: Time (s)

Depending on the load characteristics, it is possible that the motor does not stop to a standstill at the end of the ramp.

If **[Control Mode]** is set to **[Voltage Control]**, this parameter sets the ramp down of the voltage applied to the motor, from 100% to **[Freewheel level dec]** (*EDCV*) of the mains supply. Below **[Freewheel level dec]**, the voltage applied drop to 0% and the motor stops in freewheel.

Example of the nominal torque when a Stop order is applied:

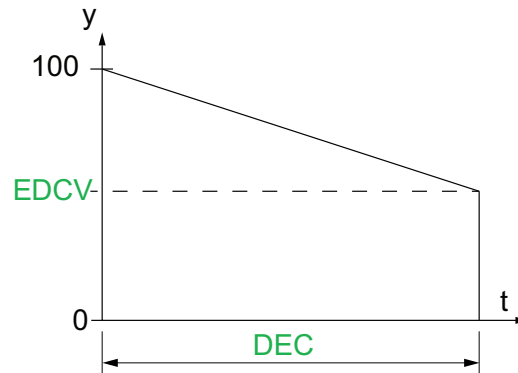

- y: Applied mains voltage as % of the mains voltage
- t: Time (s)

Depending on the load characteristics, it is possible the motor does not stop to a standstill at the end of the ramp.

This parameter can be accessed only if **[Type of stop]** or an error behavior is set to **[Deceleration]**.

[Freewheel level dec] <i>EDCV</i>	25...100% of estimated voltage when a Stop order is applied	30%
------------------------------------------	-------------------------------------------------------------	-----

Threshold for changing to freewheel stop in voltage control



Only accessible via **[Complete settings]** → **[Start & Stop]**

As soon as the estimated applied voltage is below the value set in **[Freewheel level dec]** (point "a" in the figure above), the motor stops in freewheel.

This parameter can be accessed if:

- **[Control Mode]** is set to **[Voltage Control]**.
- **[Type of stop]** is set to **[Deceleration]**.

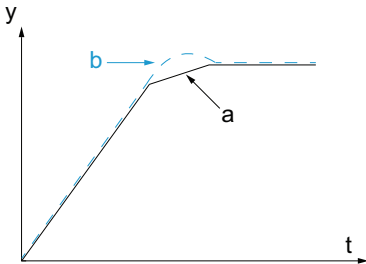
Enhance the motor control :

HMI label	Setting	Factory setting
[Deceleration Gain] TIG	10...50 %	40 %
<p>Torque control deceleration gain</p> <p>In case of instability when decelerating, [Deceleration Gain] value can be gradually reduced.</p> <p>This parameter can be accessed if:</p> <ul style="list-style-type: none"> • [Control Mode] is set to [Torque Control]. • [Type of stop] is set to [Deceleration]. 		
[Torque Limit] TLI 	10...200% of nominal torque or [No]	[No]
<p>Torque limit</p> <p>This parameter:</p> <ul style="list-style-type: none"> • Set the final torque of the torque-controlled acceleration when [Control Mode] it set to [Torque Control]. • Limit the torque reference to avoid regenerative behavior in applications with high inertia. • Can be used for constant starting torque if [Init Starting Torque] = [Torque Limit] and if the application load is compliant. <div style="display: flex; align-items: flex-start;"> <div style="flex: 1;">  </div> <div style="flex: 1; margin-left: 20px;"> <ul style="list-style-type: none"> • y: Motor speed • t: Time (s) • a: No generative mode with appropriate TLI • b: Generative mode without appropriate TLI </div> </div> <p>This parameter can be accessed if [Control Mode] is set to [Torque Control].</p>		
[Stator Loss Comp] LSC 	0...90 %	25 %
<p>Stator loss compensation</p> <p>Only in torque control</p> <p>In the event of torque oscillations, reduce this parameter gradually until the motor is properly operating. Oscillations are most common if the soft starter is connected in the motor delta winding or with motors with excessive slip. Modifying this parameter has an impact on torque estimation.</p>		

Braking

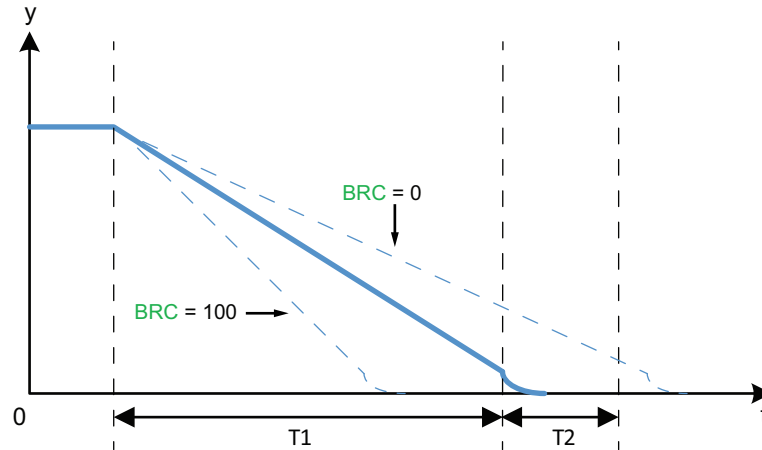

- y: Nominal speed.
- t: Time (s).
- T1: Dynamic braking time, ramp set by **[Braking Level]**.
- T2: Adjustment of motor stop by **[DC Braking Time]**.

Pseudo-continuous injection time: $T2 = T1 \times \text{[DC Braking Time]}$.

NOTE: Time T1 is dependant of **[Braking Level]**. The higher the value, the stronger is the braking and the faster is the ramp.

Description	Setting range	Factory setting
[Braking Level] BRC	0...100%	50%
<p>Dynamic braking level</p> <p>This parameter can only be accessed if [Type of stop] or an error response is set to [Braking]. Braking is active according to the value set by [Braking Level]. The total stopping time of the motor is configured by adjusting the injection time of the pseudo-direct current in the motor applied on two phases. See next parameter [DC Braking Time].</p> <div style="border: 1px solid black; padding: 5px; text-align: center;"> <h2 style="margin: 0;">NOTICE</h2> <p>MECHANICAL STRESS</p> <ul style="list-style-type: none"> • Do not set a high value of [Braking Level] BRC if your application have a high inertia. • Verify that this value is suitable by performing a commissioning test under maximum load conditions. <p>Failure to follow these instructions can result in equipment damage.</p> </div>		
[DC Braking Time] EBA	20...100%	20%
<p>DC continuous braking time</p> <p>This parameter can only be accessed if [Type of stop] or an error response is set to [Braking]. This parameter adjusts the current injection time at the end of braking.</p> <p>Example:</p> <p>Dynamic braking = 10 s (T1)</p> <p>[DC Braking Time] = 20% corresponds to an injection time of 2 s</p> <p>[DC Braking Time] = 100% corresponds to an injection time of 10 s</p>		

Motor Preheating

By applying a current inside the motor windings, the preheating function can be used before starting the motor to:

- Unfreeze the motor.
- Help to prevent temperature deviations and condensation.
- Start the motor at the same temperature to limit the variations between cold and warm state.

NOTE: [Time Before Preheat] should be set to ensure that the motor stops before preheating.

During preheating, the motor thermal monitoring function is not active.

NOTICE
<p>MOTOR OVERHEATING</p> <ul style="list-style-type: none"> • Verify that the connected motor is properly rated for the current to be applied in terms of amount and time. • Add an external thermal sensor to monitor the temperature of the motor if preheating operation can result in motor windings overheating. <p>Failure to follow these instructions can result in equipment damage.</p>

To monitor the motor temperature, use an external thermal sensor:

- Wire it to the soft starter PTC1/AI1 terminal and set the thermal monitoring, refer to Motor External Thermal Sensor, page 145.
- Set an output to [AI1 Th Warning].

The preheating function is not compatible with [Hardwired ctrl mode] in 2-wire control, refer to RUN and STOP Management, page 49 for more information.

For the complete list of incompatibilities, refer to Functions Compatibility Table, page 195.

NOTE: When using the [CD●●] activation and [Control Mode] set to [Standard Profile], the *Halt* command must be active to remain in the 5 - *Operation enabled* state. For further information, please refer to the associated communication manuals.

Use the preheating function by:

Continuous preheating ([Yes])	External thermal sensor ([Preheat Temp Range])	[DI●] or [CD●●] activation
The preheating is done automatically when product is in ready state.	The preheating is done automatically when product is in ready state and when measured temperature is less than [Temp Low].	<p>The preheating is done by applying a high level on the digital input assigned to [Preheating Assign] when motor is stopped.</p> <p>NOTE: When using activation through line channel ([CD●●]) and [Control Mode] is set to [Standard Profile], the <i>Halt</i> command must be active to remain in the “5 – <i>Operation enabled</i>” state. For further information, please refer to the associated fieldbus manual.</p>
The preheating is effective when [Time Before Restart] and [Time Before Preheat] are elapsed after a stop of the motor.		

Continuous preheating ([Yes])	External thermal sensor ([Preheat Temp Range])	[DI●] or [CD●●] activation
The status [Motor Preheating] <small>HEA</small> is displayed on the display terminal, even during [Time Before Restart] .		
Apply a Stop order to stop the preheating. NOTE: It is not possible to stop the preheating through terminal in [2-Wire Control] .	The preheating stops when the measured temperature is higher than [Temp High] or by applying a Stop order. NOTE: It is not possible to stop the preheating through terminal in [2-Wire Control] .	The preheating stops by applying and maintaining a low level on the digital or virtual input set to [Preheating Assign] when the product is in ready state, or by applying a Stop order

Using the function with a digital input in terminal control

Step	Action
1	Set [Preheating Assign] to a digital input.
2	Set the heating current level [Preheat Level] .
3	Set the time delay before the preheating start [Time Before Preheat] . The [Time Before Preheat] counting start when the motor is stopped. The motor will not preheat as long [Time Before Preheat] and [Time Before Restart] are not elapsed.
4	To start the preheating: <ul style="list-style-type: none"> • The motor must be stopped. • [Time Before Restart] must be elapsed. • [Time Before Preheat] is elapsed. • Apply and maintain a high level on the DI1 terminal (depends on [2/3-Wire Control] configuration). • Apply and maintain a high level on the digital input set to [Preheating Assign] in step 1. The status [Motor Preheating] is displayed on the display terminal.
5	To stop the preheating: <ul style="list-style-type: none"> • Apply and maintain a low level on the digital or virtual input set to [Preheating Assign]. • Or apply a Run order. • Or apply a Stop order.

Example of state diagram of the preheating function by digital input:

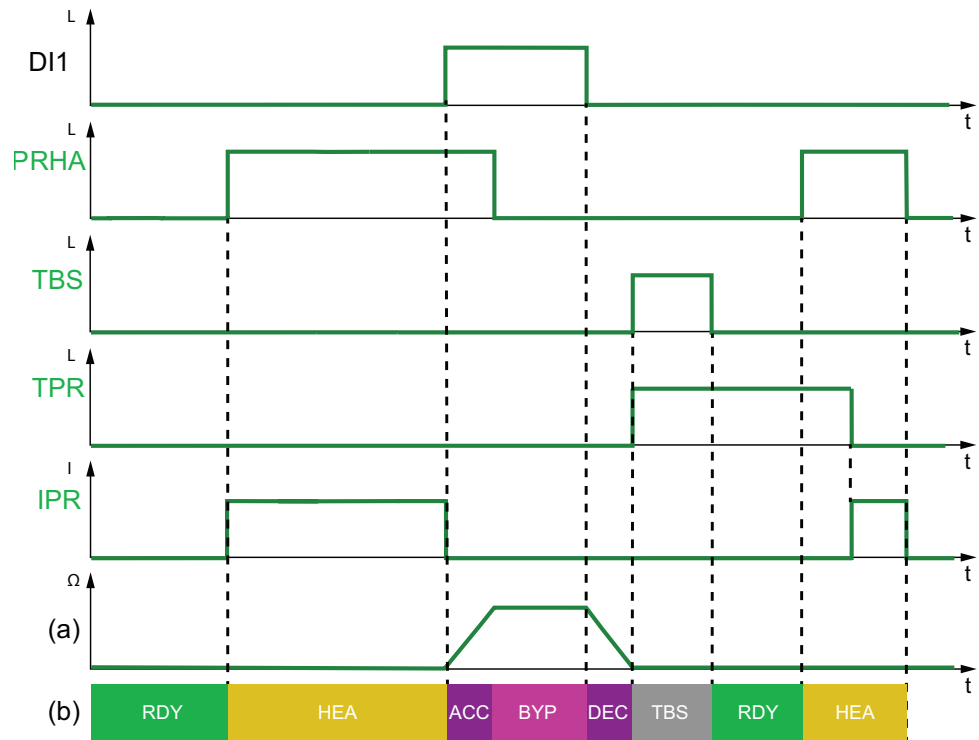

- **D11**: Run and Stop management in 2-wire control (2C). Refer to RUN and STOP Management, page 49 for more information.
- **PRHA**: Level applied to the digital inputs assigned to **Preheating assignment**.
- **TBS**: **Time before motor restart**.
- **TPR**: **Time before preheat**.
- **IPR**: Preheat current injected in the motor.
- (a): Motor rotation speed
- (b): Soft starter state. For the list of possible state of the soft starter, refer to Soft Starter State, page 331.

NOTE: [Time Before Preheat] and [Time Before Restart] are not cumulative.

Parameters description

Access path: [Complete settings] → [Preheating]

Description	Setting range	Factory setting
[Preheating Assign] <small>PRHA</small>	-	[Not Assigned] <small>NO</small>

Preheating assignment

 **DANGER**

ELECTRIC SHOCK AND/OR UNANTICIPATED EQUIPMENT OPERATION

- Verify that the setting of the parameter [Time Before Preheat] does not result in unsafe conditions.
- When preheating function is used, always consider that the equipment is in the operating state Operation Enabled.

Failure to follow these instructions will result in death or serious injury.

If the preheating is applied during the motor rotation, the preheating injection will maintain the rotation of the motor.

 **WARNING**

LOSS OF CONTROL

- Verify that preheating operation is always starting when the motor is at standstill.
- If necessary, adjust the value of the parameter [Time Before Preheat] TPR to ensure the preheating operation will start at motor standstill.

Failure to follow these instructions can result in death, serious injury, or equipment damage.

This parameter sets a digital input, or a virtual input via CMD word, (Refer to fieldbus manuals for the CMD word assignments), to start the preheating.

- **[Not Assigned]**: preheating start not assigned.
- **[Yes]**: continuous preheating.
- **[Preheat Temp Range]**: activated/deactivated by temperature thresholds. Visible only if **[AI1 Th Monitoring]** is configured, for more information refer to Motor External Thermal Sensor, page 145.
- **[DI●]**: preheating start assigned to digital input DI●.
- **[CD●●]** : preheating start assigned to line channel.

NOTE: When using activation through line channel (**[CD●●]**) and **[Control Mode]** is set to **[Standard Profile]**, the *Halt* command must be active to remain in the “5 – Operation enabled” state. For further information, please refer to the associated fieldbus manual.

Description	Setting range	Factory setting
[Preheat Level] IPR	5...70% (% of the nominal motor current)	5%
<p>Preheating level</p> <p>This parameter sets the heating current level. Use a properly rated ammeter to adjust the preheating current level. This parameter has an impact on the current created by the minimum firing angle. During preheating, the motor thermal monitoring function is not active.</p>		
<p>NOTICE</p>		
<p>MOTOR OVERHEATING</p> <ul style="list-style-type: none"> • Verify that the connected motor is properly rated for the current to be applied in terms of amount and time. • Add an external thermal sensor to monitor the temperature of the motor if preheating operation can result in motor windings overheating. <p>Failure to follow these instructions can result in equipment damage.</p>		
<p>If the frequency of the mains is not stable, the preheating current level may be increased compared to the set value and lead to motor overheating.</p>		
<p>NOTICE</p>		
<p>MOTOR OVERHEATING</p> <p>If the frequency of the mains is not stable:</p> <ul style="list-style-type: none"> • Add an external thermal sensor to monitor the temperature of the motor. <p>or</p> <ul style="list-style-type: none"> • Add an external device to monitor the frequency and switch off the preheating function in case of fluctuations. <p>Failure to follow these instructions can result in equipment damage.</p>		
<p>This parameter is visible only if [Preheating Assign] is set different from [Not Assigned].</p>		

Description	Setting range	Factory setting
[Time Before Preheat] <i>TPR</i>	0...999 min	5 min
<p>Time before preheat</p> <p>The time delay set to this parameter starts as soon as the last Stop order is applied.</p> <p>The soft starter will not preheat the motor as long as [Time Before Preheat] is not elapsed.</p> <p>The status [Motor Preheating] <i>HEA</i> is displayed on the display terminal when the preheating order is applied.</p>		
<div style="background-color: black; color: white; padding: 5px; font-weight: bold; font-size: 1.2em;">⚡⚠ DANGER</div> <div style="border: 1px solid black; padding: 5px; margin-top: 5px;"> <p>ELECTRIC SHOCK AND/OR UNANTICIPATED EQUIPMENT OPERATION</p> <ul style="list-style-type: none"> Verify that the setting of the parameter [Time Before Preheat] does not result in unsafe conditions. When preheating function is used, always consider that the equipment is in the operating state Operation Enabled. <p>Failure to follow these instructions will result in death or serious injury.</p> </div>		
<p>This parameter is visible only if [Preheating Assign] is set different from [Not Assigned].</p>		
[Temp Low] <i>TPLO</i>	Range: -15...200°C / 5...392°F Unit: selected by [Temperature unit] <i>SUTP</i> .	0.0°C / 32.0°F
<p>Preheating temperature low limit</p> <p>This parameter is visible only if [Preheating Assign] is set to [Preheat Temp Range].</p>		
[Temp High] <i>TPHI</i>	Range: -15...200°C / 5...392°F Unit: selected by [Temperature unit] <i>SUTP</i> .	0.0°C / 32.0°F
<p>Preheating temperature high limit</p> <p>This parameter is visible only if [Preheating Assign] is set to [Preheat Temp Range].</p>		

Smoke Extraction

In rare cases, the monitoring functions of the device may be unwanted because they impede the purpose of the application. A typical example is a smoke extractor fan operating as a part of a fire protection system. If a fire occurs, the smoke extractor fan should operate as long as possible, even if, for example, the permissible ambient temperature of the device is exceeded. In such applications, damage to or destruction of the device may be acceptable as collateral damage, for example, to keep other damage from occurring whose hazard potential is assessed to be more severe.

A parameter is provided to disable certain monitoring functions in such applications so that automatic error detection and automatic error responses of the device are no longer active. You must implement alternative monitoring functions for disabled monitoring functions that allow operators and/or master control systems to adequately respond to conditions which correspond to detected errors. For example, if overtemperature monitoring of the device is disabled, the device of a smoke extractor fan may itself cause a fire if errors go undetected. An overtemperature condition can be, for example, signaled in a control room without the device being stopped immediately and automatically by its internal monitoring functions.

⚠ DANGER

MONITORING FUNCTIONS DISABLED, NO ERROR DETECTION

- Only use this parameter after a thorough risk assessment in compliance with all regulations and standards that apply to the device and to the application.
- Implement alternative monitoring functions for disabled monitoring functions that do not trigger automatic error responses of the device, but allow for adequate, equivalent responses by other means in compliance with all applicable regulations and standards as well as the risk assessment.
- Commission and test the system with the monitoring functions enabled.
- During commissioning, verify that the device and the system operate as intended by performing tests and simulations in a controlled environment under controlled conditions.

Failure to follow these instructions will result in death or serious injury.

This function can be used to disable the following monitoring functions:

- [Line Short Circuit] `BYF1`
- [Bypass Closing Error] `BYF2`
- [Bypass Open Error] `BYF3`
- [ByPass Overcurrent] `BYF4`
- [Invalid Config] `CFI`
- [Control Supply Error] `CLF`
- [Fdbus Com Interrupt] `CNF`
- [CANopen Com Interrupt] `COF`
- [STO On Inside Delta] `DLTF`
- [In Delta Wiring Error] `DWF`
- [External Error] `EPF1`
- [Embd Eth Com Interrupt] `ETHF`
- [FDR 1 Error] `FDR1`
- [Fan Feedback Error] `FFDF`
- [Mains Freq Error] `FRF`
- [FW Update Error] `FWER`
- [No Power Comm Error] `FWMC`
- [Fware Pairing Err] `FWPF`
- [Boards Compat] `HCF`
- [Internal Error 11] `INFB`
- [Internal Error 21] `INFL`
- [Internal Error 22] `INFM`
- [Internal Error 26] `INFQ`
- [Internal Error 35] `INFZ`
- [Input Contact. Closed] `LCCF`
- [Input Contactor] `LCF`
- [Mains Direction Error] `MDDF`
- [Mains Nom. Volt. Error] `NOSF`
- [Overcurrent] `OCF`
- [Device Overheat] `OHF`
- [Process Overload] `OLC`
- [Motor Overload] `OLF`
- [Output Phase Loss] `OPF`
- [Supply Mains OverV] `OSF`
- [Prog Load Error] `PGLF`
- [Input Phase Loss] `PHF`
- [SCR Sync Error] `SDF`
- [Mdb Com Interrupt] `SLF1`
- [PC Com Interrupt] `SLF2`
- [HMI Com Interruption] `SLF3`
- [Simu Mains Detected] `SMPF`
- [Security Files Corrupt] `SPFC`
- [Sec Policy Update Err] `SPTF`
- [AI1 Th Sensor Error] `T1CF`
- [AI1 Th Level Error] `TH1F`
- [Device Overheat] `TJF`
- [Too Long Start Err] `TLSF`
- [Proc Underload] `ULF`
- [Supply Mains UnderV] `USF`

The warnings are still recorded in [Diagnostics] → [Diag. data] → [Last Warning].



NOTE:

- When this function is enabled, it is advised to add relevant warnings of inhibited error to a warning group to be able to monitor them more easily.
- Take into account that the STO safety function wired on the terminal always has the priority over forced run configured for smoke extraction. To avoid unwanted triggering of the STO function in the event of a fire, it is recommended to keep the strap on the terminal between STO and 24V.

NOTE: The Smoke Extraction function is not compatible with some functions. Refer to Functions Compatibility Table, page 195 for more information.

Parameters description

Access path: [Complete settings] → [Smoke Extraction]

Description	Setting	Factory setting
[Disable Error Detect] <small>INH</small> 	—	[Not Assigned] <small>NO</small>
<p>Disable error detection</p> <p>This parameter sets a digital input, or a virtual input via CMD word, (Refer to fieldbus manuals for the CMD word assignments), to disable error detection.</p> <ul style="list-style-type: none"> • [Not Assigned]: Error inhibition not assigned. • [DI●]: Error inhibition assigned to digital input DI●. • [DI● (Low level)]: Error inhibition assigned to digital input DI● low level. • [CD●●]: Error inhibition assigned to line channel. <p>Apply a high or low level to the assigned digital input to inhibit the error detection.</p>		
<p>⚠ WARNING</p>		
<p>UNANTICIPATED EQUIPMENT OPERATION</p> <p>Verify that permanently forcing the Run command via the digital input set to [Disable Error Detect] <small>INH</small>, does not result in unsafe conditions.</p> <p>Failure to follow these instructions can result in death, serious injury, or equipment damage.</p>		
[Forced Run] <small>INHS</small> 	—	[Disabled] <small>NO</small>
<p>Forced Run</p> <p>This parameter can be set to:</p> <ul style="list-style-type: none"> • [Disabled]: Not configured. • [Forced Run FW]: error inhibition asks for a forward run order. • [Forced Run RV]: error inhibition asks for a reverse run order (when [Reverse Assign] is configured). <p>[Forced Run] is forced to [Disabled] when [Disable Error Detect] is assigned on a virtual input.</p>		
<p>⚠ WARNING</p>		
<p>UNANTICIPATED EQUIPMENT OPERATION</p> <p>If [Disable Error Detect] <small>INH</small> is set to a digital input active at low level and [Forced Run] <small>INHS</small> is enabled, you must ensure that the digital input is wired and inactive when the configuration is done and/or applied.</p> <p>Failure to follow these instructions can result in death, serious injury, or equipment damage.</p>		
<p>This parameter is visible only if [Disable Error Detect] is set to a digital or virtual input.</p>		

Voltage Boost

This function can be used to provide a boost at the start to overcome a mechanical hard point.

As an application example, a chocolate crusher. The grinding of the chocolate is done when it's hot. Once the motor is stopped, the chocolate cools down, glueing the roller flatteners. In order to overcome the resistant torque due to the rollers being stuck by the chocolate and the elasticity of the material, it is necessary to apply a higher initial torque.

The voltage boost can be used in torque control and voltage control.

The voltage boost function apply a level of the nominal voltage **[Mains Voltage]** between 50% and 100% for 100 ms.

Access path: **[Complete settings]** → **[Start & Stop]**

Boost with torque control:

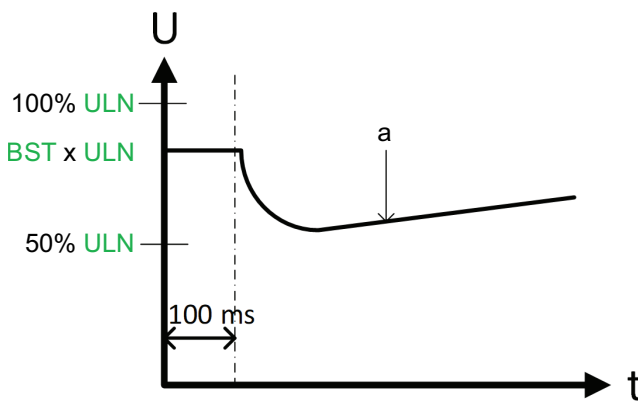

a: Voltage generated by the torque control

ULN: **Mains voltage**

BST: **Voltage boost level**

Boost with voltage control:

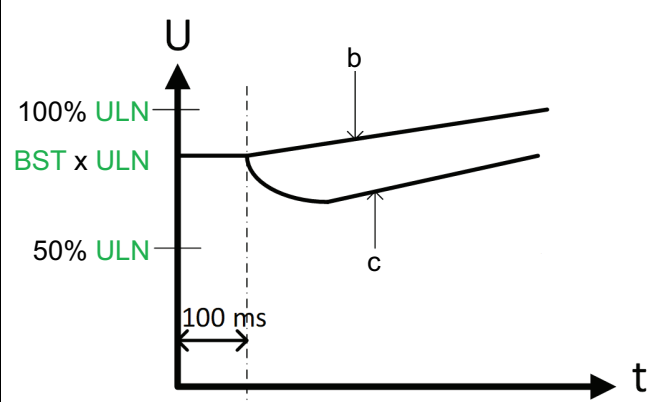

b: Voltage ramp initialized to **[Boost]** value

c: Voltage ramp in case of current limitation

ULN: **Mains voltage**

BST: **Voltage boost level**

Description	Setting range	Factory setting
[Boost Assign] <small>BSTE</small>		[Not Assigned] <small>NO</small>
Boost assignment This parameter sets a digital input, or a virtual input via CMD word, (Refer to fieldbus manuals for the CMD word assignments), to activate the boost. <ul style="list-style-type: none"> • [Not Assigned]: Boost not assigned. • [Yes]: Boost will be activated on each motor start. • [DI●]: Boost assigned to digital input DI●. • [CD●●]: Boost assigned to line channel. 		
[Boost] <small>BST</small>	50%...100% of [Mains Voltage] <small>ULN</small>	50%
Voltage boost level Setting the value of this parameter too high can cause overcurrent and trigger error such as [Overcurrent] .		

Borehole Pump

When starting a borehole pump, there is a lot of friction without any possibility of lubrication. A slow start will result in excessive friction and could cause damage or unexpected wear. This function allows to quickly start following a first torque limit, and smoothly complete the start following a second torque limit.

This function is not compatible with **[2nd Mot Parameters]**.

[Start pump trajectory] is visible only if **[Control Mode]** is set to **[Torque Control]**.

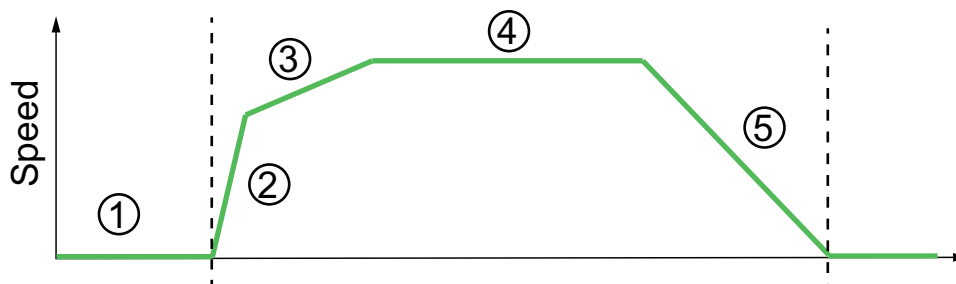

1. Motor is stopped.
2. The function **[Start Pump Assign]** is active. The soft starter starts the motor following a high torque limit set in **[Start Pump Torq Limit]**, until reaching the timer **[Start Pump Time]**
3. After reaching the timer **[Start Pump Time]**, the soft starter automatically switches to a slow ramp, and completes the start following a lower torque limit set in **[Torque Limit]** during a user defined time on **[Acceleration]**.
4. The soft starter is bypassed and motor run at nominal speed.
5. The stop mode is independent from the start borehole pump selection.

Access path: **[Complete settings]** → **[Start pump trajectory]**

HMI label	Setting	Factory setting
[Start Pump Assign] SPTA	-	[Not Assigned] NO
Start pump trajectory activation assignment		
This function can be set to:		
<ul style="list-style-type: none"> • [Not Assigned]: Start pump trajectory not assigned. • [Time Delay]: Start pump trajectory function is activated on every start. The switch between high torque limit [Start Pump Torq Limit] and lower torque limit [Torque Limit] is done after the timer [Start Pump Time]. 		
[Start Pump Torq Limit] TLIS	100...200% of nominal torque	200%
Start pump maximum torque limit		
This parameter sets the torque limitation level in torque control for the pump start profile, in percent of nominal torque.		
[Start Pump Torq Limit] cannot be set to a value lower than [Torque Limit] .		
[Start Pump Time] SPTD	0...30.0s	2.0s
Start pump trajectory time		
NOTE: [Start Pump Time] cannot be set to a value higher than the value set in [Acceleration] .		

Reverse by External Contactor

Wiring diagram

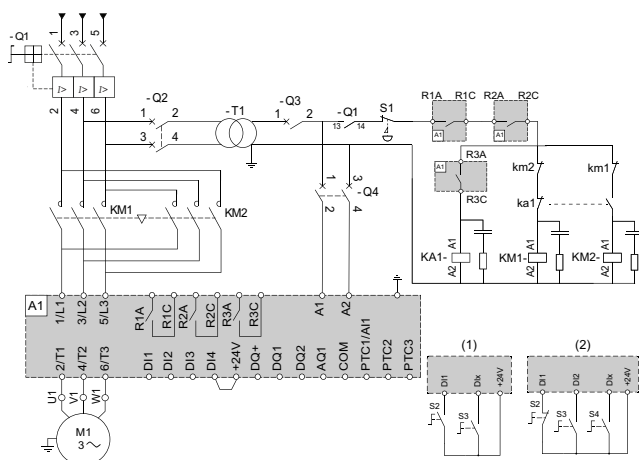

This function enables the motor to be operated in both directions using external contactors and a dedicated electromechanical sequence.

This function cannot be used if **[2/3-Wire Control]** is set to **[Hardwired ctrl mode]**.

It is recommended to use the line contactor function when using Reverse by External Contactor. Refer to **Mains Contactor Command**, page 155 for more information.

NOTE: To be able to run in reverse direction, the **[Reverse Assign]** parameter should be assigned to an input. See , page 181.

NOTE: Configure **[Phase Inversion Mon]** to define the Forward direction. The detected phase direction is displayed in **[Phase Direction]**.

Designation	Component	Description
Q1	Circuit breaker	Short circuit protection device for the motor
Q2	Circuit breaker	Short circuit protection device for the primary of the transformer
Q3	Circuit breaker	Short circuit protection device for the secondary of the transformer
Q4	Circuit breaker	Short circuit protection device for the control part of the soft starter
KM1	Contacteur	Forward
KM2	Contacteur	Reverse
KA1	Auxiliary Contacteur	Auxiliary Contacteur in the sequence.
R1	Internal relay of the soft starter	[R1 Assignment] is set to [Operating State Fault] (factory setting).
R2	Internal relay of the soft starter	[R2 Assignment] is set to [Mains Contactor] LLC .
R3	Internal relay of the soft starter	[R3 Assignment] is set to [Fwd/Rev by Contactor] RCC or [Cmd Relay Selection] set to [R3] . Not possible if [2/3-Wire Control] is set to [Hardwired ctrl mode] .
S1	Emergency Stop push-button	Emergency Stop to de-energized KM1 and KM2.
S2	Normally open contact push-button	(1) Reverse by contactor with 2 wire control diagram. DI1 : Run Forward.
	Normally close contact push-button	(2) Reverse by contactor with 3 wire control diagram. DI1 : Run Enable.
S3	Normally open contact push-button	(1) Reverse by contactor with 2 wire control diagram. Dlx : Digital Inputs DI2, DI3 or DI4. Run Reverse.
		(2) Reverse by contactor with 3 wire control diagram. DI2 : Run Forward.
S4	Normally open contact push-button	(2) Reverse by contactor with 3 wire control diagram. Dlx : Digital Inputs DI3 or DI4. Run Reverse.

Chronograph

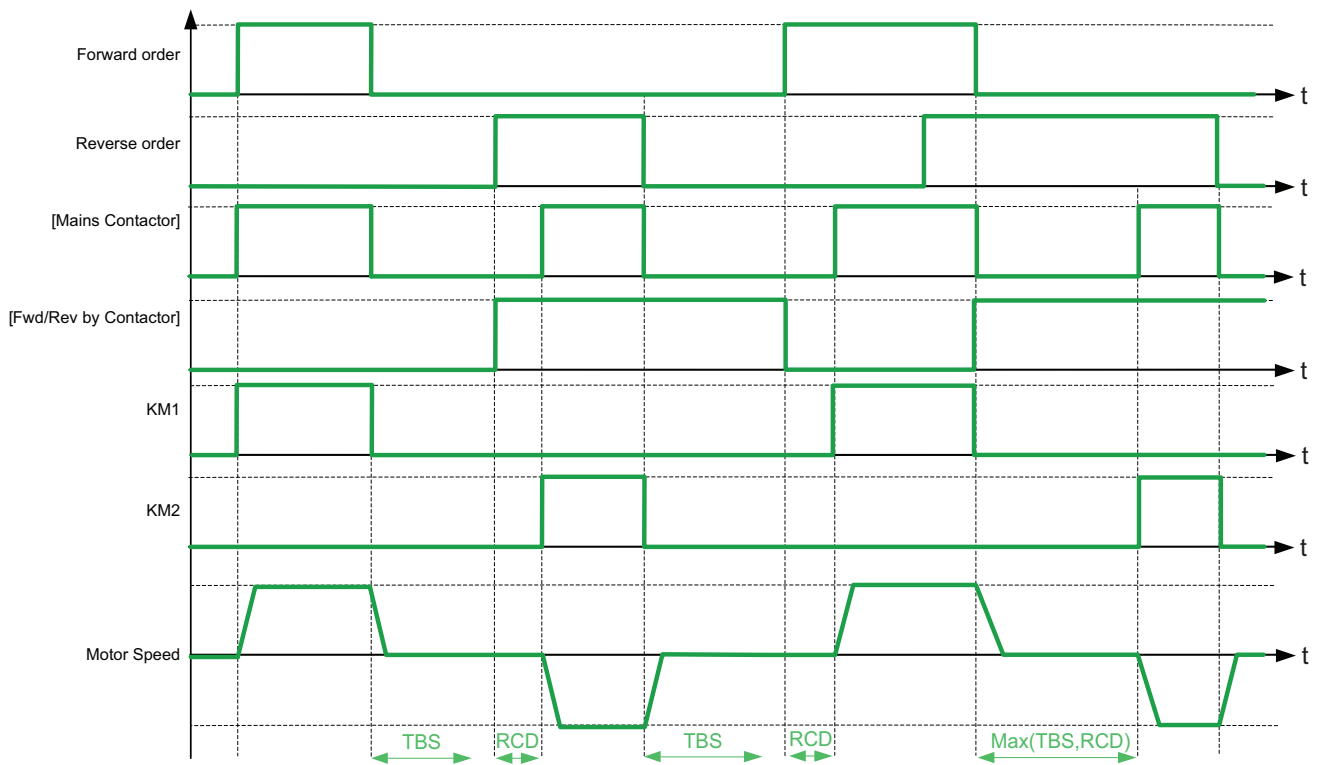

- **TBS:** *Wait for motor restart* status. For more information refer to How to interpret and react to a TBS state, page 328.
- **RCD:** *Change Direction Delay*.

[Cmd Relay Selection] RCCAccess path : **[Complete settings] → [Reverse by contactor]**

Description	Setting range	Factory setting
[Cmd Relay Selection] RCC	—	[Not Assigned] NO
Reverse contactor command relay selection To be able to run in reverse direction, this parameter should be assigned to a relay: <ul style="list-style-type: none"> • [Not Assigned]: Function not assigned. • [R2]: Assigned to relay R2. • [R3]: Assigned to relay R3. 		

[Cmd Relay Selection] must be assigned to a relay to be able to configure the parameters below :

[Reverse Assign] RRSAccess path : **[Complete settings] → [Reverse by contactor]**OR : **[Complete settings] → [Command channel]**

Description	Setting range	Factory setting
[Reverse Assign] RRS	—	[Not Assigned] NO
Reverse assignment To be able to run in reverse direction, this parameter should be assigned to an input : <ul style="list-style-type: none"> • [Not Assigned]: Function not assigned. • [DI●] : Assigned to Digital Input. • [CD●●] : Assigned to Virtual Input (available when [I/O profile] is selected). Refer to the fieldbus manuals for the CMD word assignments. <p>NOTE: BIT 11 of the <i>Command register</i> is assigned by default to this function.</p>		

[Change Dir Delay] RCDAccess path : **[Complete settings] → [Reverse by contactor]**

Description	Setting range	Factory setting
[Change Dir Delay] RCD	1...10 s	2 s
Change Direction Delay This parameter allows to configure the delay to switch from Forward to Reverse, and from Reverse to Forward. <p>NOTE: On high motor power, [Change Dir Delay] might be set to a higher value to take into account the longer duration of the motor's remanent voltage.</p>		

Motor Jog

This function allows to move an engine manually until a given position, at a speed lower than the normal speed. This function is used for example to put a conveyor belt into position.

This function is incompatible with some other functions, refer to Functions Compatibility Table, page 195.

NOTE:

- The jog sequence is automatically stopped if running continuously in Jog mode for **3 minutes**.
- If the Jog sequence lasts too long, additional upstream thermal relay/circuit breaker may trip. Please refer to the tripping curve of your upstream thermal relay/circuit breaker in order to properly size the system with the Jog function.
- Parameter settings, motor characteristics and motor load may influence the real motor speed resulting from the Jog function.
- Entering and leaving the Jog mode, requires the motor to be at standstill.

During the Jog operation, the motor thermal monitoring function is not accurate.

NOTICE

MOTOR OVERHEATING

Add an external sensor to monitor the temperature of the motor.

Failure to follow these instructions can result in equipment damage.

During the Jog operation, noise development and oscillations of the system due to torque ripple can be observed.

For some application, Jog command could not be able to develop enough torque to start the motor, even with the parameter [**Torque Level**] JOGF set at 100%.

NOTICE

MECHANICAL STRESS

- Always verify during commissioning testes that jog operation does not generate abnormal mechanical stress to the installation.
- Jog command must be activated only when the motor is at standstill.
- Take into account limitations of Jog operation in forward and reverse direction depending on the type of motor and motor load, by performing extensive commissioning test to verify Jog operation is fully complying to the application.

Failure to follow these instructions can result in equipment damage.

Jog mode can be used through Graphic Display Terminal (**[Act By HMI]**) or through line channel (**[CD••]**).

The function is accessible in the **[Simply Start]** menu, in the **JOG** tab, if **[Jog Assign]** is set to **[Act By HMI]**.

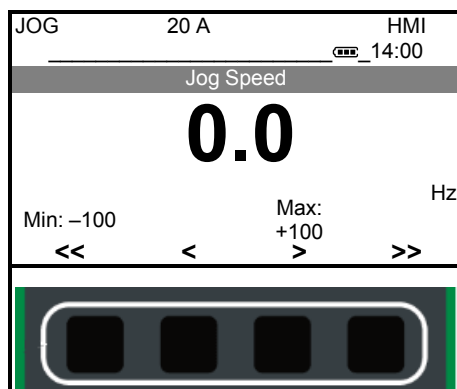

The jog has 2 different speeds, slow and very slow, in both directions. Use the 4 functions keys (F1 to F4) on your Graphic Display Terminal.

Access path : [Complete settings] → [Jog]

Description	Setting range	Factory setting
[Jog Assign] JOG	—	[Not Assigned] NO
<p>Jog assignment</p> <ul style="list-style-type: none"> • [Not Assigned]: Jog mode is disabled. • [Act By HMI]: Jog mode is enabled only on the graphic display terminal. It is accessible in [Simply Start], by doing so, the command channel is set to [HMI]. NOTE: Entering [Jog] by Graphic Display Terminal is only possible if motor is stopped. • [CD●●] Jog mode is enabled with line channel. NOTE: To do some JOG reverse: <ul style="list-style-type: none"> ◦ in [Standard Profile], [Cmd Register] bit 11 is the bit used by default to do a reverse (if the bit is not assigned to another function). ◦ in [I/O profile], [Reverse Assign] RRS must be configured to be able to do a reverse JOG. ◦ After disabling the bit assigned to jog operation, it is necessary to re-apply a run command. 		
[Slow Speed Assign] JOS A	—	[No]
<p>Jog slow speed assignment</p> <p>This parameter can be used to select the speed to apply during Jog mode, between slow and very slow, with virtual inputs via CMD word (Refer to fieldbus manuals for the CMD word assignments) when COM line could run motor in Jog mode.</p> <p>[No] : Very low speed is not assigned.</p> <p>[CD●●] Very low speed at high level on assigned virtual input, low speed at low level on assigned virtual input.</p> <p>This parameter cannot be accessed if [Jog Assign] is set to [Act By HMI].</p>		
[Torque Level] JOG F	10...100%	20%
<p>Torque Level</p> <p>Test the installation with the default value of 20%. If the developed torque is not enough to move the load, increase gradually by steps of 5% for example.</p> <p>When [Torque Level] is set to 20%, it corresponds to RMS current value of approximately 1xIn.</p> <p>When [Torque Level] is set to 100%, it corresponds to RMS current value of approximately 3xIn.</p>		
[Jog Reverse Mode] JOG R	—	[Device Motor Control] INTERN
<p>Jog Reverse Mode</p> <ul style="list-style-type: none"> • [Device Motor Control] : The function Reverse by Contactor is not configured. Reverse is done by internal motor control. A sequence that reverses the voltage sequence applied to the motor. NOTE: Depending on the torque needed to start jog operation in reverse, it may be necessary to use a reverse contactor in the wiring sequence. • [External Contactors] : The function Reverse by Contactor is configured. Phase reversal is done using an external contactor. 		

Anti-Jam

In waste water applications, clogging substances reduce the efficiency of the system and may decrease the pump service life. Therefore, the Anti-Jam function can help drastically reduce the number of blocking in an impeller, pipe, or valve at downstream location.

The Anti-Jam function allows, manually and/or automatically, to execute reverse and forward pump rotation cycles.

The Anti-Jam function is not compatible with some functions. Refer to Functions Compatibility Table, page 195 for more information.

NOTICE
<p>INOPERATIVE MOTOR, PUMP, AND OTHER EQUIPMENT DUE TO MECHANICAL STRESS</p> <ul style="list-style-type: none"> • Verify that the motor, the pump and all other equipment are suitable for reverse operation before using this function. • Verify that the setting of the parameter [Time Before Restart] TBS is set high enough to ensure the anti-jam sequence will start only when the motor is at standstill. <p>Failure to follow these instructions can result in equipment damage.</p>

Access path : **[Complete settings]** → **[Anti-Jam]**

Anti-Jam Modes

Embedded	External (Reverse by contactor)
No additional hardware is required	Reversing contactor assembly is connected upstream of the Altivar Soft Starter ATS490. See chapter Reverse by External Contactor , page 179
The reverse duty in the function can only be operated in reduced speed	The reverse duty in the function can operate at full speed
Reduced torque	Maximum torque of 100%
Appropriate for inhibiting the buildup of extensive dirt deposits	Much more effective and able to remove bigger dirt accumulations on the impeller.
The parameter [Anti-Jam Rv Speed] is set to [Low Force] or to [Very Low Force] .	The parameter [Anti-Jam Rv Speed] can be set to [Starter profile] additionally to the other possible settings.

Anti-Jam Types of Trigger

The Anti-Jam function can be triggered:

- Manually, by an external trigger which can be assigned to a digital input when using a display terminal, or to a control word bit when using a fieldbus (In **[Standard Profile]**, the device must be in “5 – Operation enabled”, to engage Anti-Jam sequence. Note that the Halt bit has priority over Anti-Jam).

NOTE: During an anti-jam sequence, if the user resets the **Dlx** or **control word bit** to 0, the sequence stops.

Stop and Start conditions of the motor depend on the configuration of **[2/3-Wire Control]** and **[2-wire type]** (Refer to Set Type of Wire Control, page 121).

- Automatically on motor current overload condition. The soft starter will stop the motor then start the Anti-Jam sequence.
After an Anti-Jam sequence ends, the device will stay in running state if a start order is still present and the motor will start.

Anti-Jam Cycle

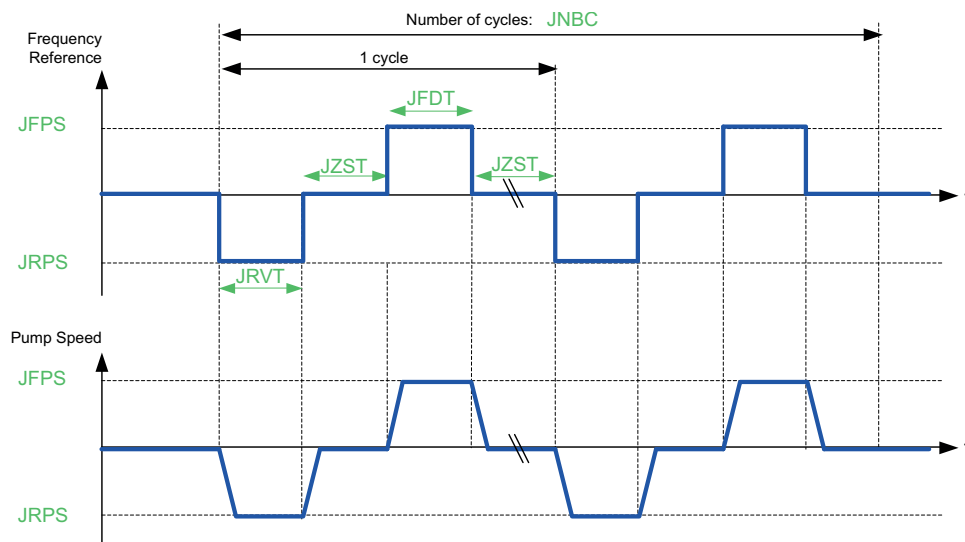

An Anti-Jam cycle is composed of:

- 1 reverse action according to **[Anti-Jam Rv Time] JRVT**, **[Anti-Jam Rv preset] JRPS**,
- 1 stop action during **[Anti-Jam Stop Time] JZST**,
- 1 forward action according to **[Anti-Jam Fwd Time] JFDT**, **[Anti-Jam Fwd preset] JFPS**,
- 1 stop action during **[Anti-Jam Stop Time] JZST**,

An Anti-Jam sequence corresponds to a number of consecutive anti-Jam cycles: **[Anti-Jam Cycle Nb] JNBC**

NOTE: If the Anti-Jam is started when the device is in running state, the soft starter will stop the motor then start the Anti-Jam sequence.

Anti-Jam Counting

The anti-Jam function monitors the number of sequences during a configured time interval **[Anti-Jam Interval]**. It helps to detect untimely aging of the system and abnormal operation.

An internal counter counts the number of sequences. Each time the sequence is started, the counter is incremented. It is reset each time the timer **[Anti-Jam Interval]** is elapsed, if no other Anti-Jam sequence is requested in the meantime.

If the counter reaches the maximum number allowed set by **[Anti-Jam Max Seq]**, the error **[Anti Jam Error]** is triggered. The motor stops in freewheel.

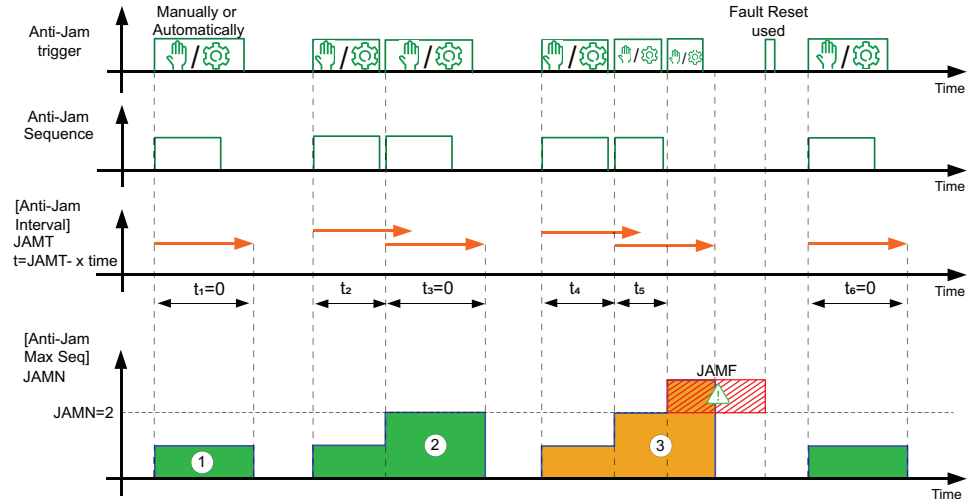

1. Use Case 1:

The user requests one anti-jam sequence by an action on the **Anti-Jam trigger** (or Automatically). Internal counter is incremented by one (counter = 1).

2. Use Case 2:

The user requests one anti-jam sequence by an action on the **Anti-Jam trigger** (or Automatically). Internal counter is incremented by one (counter = 1).

After t_2 , the user requests another anti-jam sequence by an action on **Anti-Jam trigger**. Internal counter is incremented by one (counter = 2).

NOTE: After the end of the timer set by **[Anti-Jam Interval]**, **[Anti-Jam Max Seq]** internal counter resets (counter = 0).

3. Use Case 3:

The user requests one anti-jam sequence by an action on the **Anti-Jam trigger** (or Automatically). Internal counter is incremented by one (counter = 1).

After t_4 , the user requests another anti-jam sequence by an action on **Anti-Jam trigger**. Internal counter is incremented by one (counter = 2).

After t_5 , the user requests another anti-jam sequence by an action on **Anti-Jam trigger**. Internal counter is incremented by one (counter = 3).

The internal counter value is greater than **[Anti-Jam Max Seq]**.

Error **JAMF** (**[Anti Jam Error]**) is triggered.

End of Anti-Jam Sequence:

Anti-Jam type of trigger	Type of control	Motor condition at end of Anti-Jam sequence if run order is present	
[Anti-Jam Auto Trig] set to [Current Overload].	—	The soft starter will stay in running state if start order still present and the motor will start according to application start conditions.	
[Ext Anti-Jam Trigger] set to a digital input. [Ext Anti-Jam Trigger] set to a virtual input in [I/O profile].	[2/3-Wire Control] set to [Hardwired ctrl mode]	Anti-Jam sequence ends and motor starts.	
	[2/3-Wire Control] set to [2-Wire Control]	[2-Wire Control] is set to [Level]	Anti-Jam sequence ends and motor starts.
	[2/3-Wire Control] set to [2-Wire Control]	[2-Wire Control] is set to [Transition]	Anti-Jam sequence ends, motor doesn't start. To start the motor, reset the command on [Ext Anti-Jam Trigger] and a new RUN order is required after end of Anti-Jam sequence.
[2/3-Wire Control] set to [3-Wire Control]		Anti-Jam sequence ends, motor doesn't start. To start the motor, reset the command on [Ext Anti-Jam Trigger] and a new RUN order is required after end of Anti-Jam sequence.	
[Ext Anti-Jam Trigger] set to a virtual input in [Standard Profile].	—	Anti-Jam sequence ends and motor starts according to CMD value.	

Commissioning

HMI label	Setting	Factory setting
[Ext Anti-Jam Trigger] <i>JETC</i>	—	[No] NO
External Anti-Jam trigger		
<ul style="list-style-type: none"> [No] : External Anti Jam is not configured [DI●]: assigned to dedicated digital input DI●. The Anti-Jam sequence starts sequence only in [HMI] or [Terminal]. [CD●●]: Anti-Jam is enabled with line channel. 		
[Anti-Jam Auto Trig] <i>JATC</i>	—	[No] NO
Automatic Anti-Jam trigger		
<ul style="list-style-type: none"> [No] : Automatic Anti-Jam is not enabled. [Current Overload]: Anti-Jam trigger is triggered automatically on motor overload conditions <p>If [Anti-Jam Auto Trig] is set to [Current Overload], [Ovld Detection Delay] and [Overload Threshold] are preset and can be configured.</p> <p>If [Anti-Jam Auto Trig] is disabled, the function [Overload Activation] remains active, therefore the parameters [Ovld Detection Delay] and [Overload Threshold] remain visible. Refer to Process Overload, page 133 for more information.</p>		
[Ovld Detection Delay] <i>TOL</i>	0...60 s	10 s
Overload detection delay		
<p>This parameter sets the time delay to activate [Anti-Jam] on [Current Overload] when the [Overload Threshold] is reached only if [Anti-Jam Auto Trig] is configured.</p> <p>It is reset to zero if the current drops down below the value of [Overload Threshold]. For more information, refer to Process Overload, page 133.</p>		
[Overload Threshold] <i>LOC</i>	50...200% of [Motor Nom Current]	80%
Current overload threshold		
<p>This parameter is used to set the motor current threshold value for [Anti-Jam] on [Current Overload] to activate.</p>		

HMI label	Setting	Factory setting
[Torque Level] JOGF	10...100%	20%
<p>Torque Level</p> <p>It is recommended to set this parameter on the default value of 20%. If the developed torque is not enough to run the load, it is advised to increase gradually by steps of 5% for example to avoid thermal and mechanical damage.</p> <p>When [Torque Level] is set to 20%, it corresponds to a current of 1xIn.</p> <p>When [Torque Level] is set to 100%, it corresponds to a current of 3xIn.</p>		
[Anti-Jam Rv Time] JRVT	0...180s	5s
<p>Anti-Jam reverse time</p> <p>Time to set the duration of each Reverse cycle's phase into Anti-Jam sequence.</p>		
[Anti-Jam Fwd Time] JFDT	0...180s	5s
<p>Anti-Jam forward time</p> <p>Time to set the duration of each Forward cycle's phase into Anti-Jam sequence.</p>		
[Anti-Jam Rv preset] JRPS	—	[Low Force] LOW
<p>Anti-Jam reverse preset</p> <p>Speed of each Reverse cycle's phase into Anti-Jam sequence.</p> <ul style="list-style-type: none"> • [Starter profile]: Start the motor following the soft starter start profile. refer to Set Start Profile, page 124 NOTE: Available only when [Rev/Fwd By Contactor] is assigned. Refer to Reverse by External Contactor , page 179 for more information. • [Low Force]: Start the motor in Jog mode • [Very Low Force]: Start the motor in jog mode with lower torque <p>This parameter configuration depends on the application. Configure [Anti-Jam Rv Speed] to [Starter profile] If [Low Force] is not enough to run the load. During the anti-jam operation at [Low Force] or [Very Low Force], the motor thermal monitoring function is not accurate.</p>		
NOTICE		
<p>MOTOR OVERHEATING</p> <p>If the parameter [Anti-Jam Rv preset] is set to [Low Force] or [Very Low Force], add an external sensor to monitor the temperature of the motor.</p> <p>Failure to follow these instructions can result in equipment damage.</p>		

HMI label	Setting	Factory setting
[Anti-Jam Fwd preset] <i>JFPS</i>	—	[Low Force] <i>LOW</i>
<p>Anti-Jam forward preset</p> <p>Speed of each Forward cycle's phase into Anti-Jam sequence.</p> <ul style="list-style-type: none"> • [Starter profile]: Start the motor following the soft starter start profile. refer to Set Start Profile, page 124 • [Low Force]: Start the motor in Jog mode • [Very Low Force]: Start the motor in Jog mode with lower torque <p>During the anti-jam operation at [Low Force] or [Very Low Force], the motor thermal monitoring function is not accurate.</p>		
NOTICE		
<p>MOTOR OVERHEATING</p> <p>If the parameter [Anti-Jam Fwd preset] is set to [Low Force] or [Very Low Force], add an external sensor to monitor the temperature of the motor.</p> <p>Failure to follow these instructions can result in equipment damage.</p>		
[Anti-Jam Stop Time] <i>JZST</i>	2...300s	2s
<p>Anti-Jam stop time between forward and reverse</p> <p>Stop time between forward step and reverse step into Anti-Jam sequence.</p> <p>If [Time Before Restart], or other delay, is set higher than [Anti-Jam Stop Time], the stopping phase will be equal to the highest delay. Refer to How to interpret and react to a TBS state, page 328 for more information.</p>		
[Anti-Jam Stop Mode] <i>JAST</i>	—	[Freewheel] <i>F</i>
<p>Anti-Jam profile stop mode</p> <p>Stop mode after each forward step and/or reverse step into Anti-Jam sequence.</p> <p>It can be set to:</p> <ul style="list-style-type: none"> • [Freewheel] : Freewheel stop. • [Deceleration] : Soft stopping by control of torque. <p>NOTE: Only taken into account when [Starter profile] is selected.</p>		
[Anti-Jam Cycle Nb] <i>JNBC</i>	1...10	3
<p>Anti-Jam cycle number</p> <p>Number of Forward and Reverse cycles for a complete Anti-Jam sequence.</p>		
[Anti-Jam Max Seq] <i>JAMN</i>	1...5	2
<p>Maximum allowed consecutive Anti-Jam sequences</p> <p>Maximum consecutive anti-Jam sequences allowed.</p> <p>The internal counter of consecutive Anti-Jam sequences is re-initialized at power-up.</p>		
[Anti-Jam Interval] <i>JAMT</i>	0...3600s	120s
<p>Time interval to define two Anti-Jam sequences as consecutive</p> <p>Anti-Jam minimum time between two non-consecutive sequences. An internal counter counts the number of sequences.</p> <p>If [Anti-Jam Interval] is set to 0, the consecutive Anti-jam sequences is no longer monitored.</p>		

Second Set of Motor Parameters

Introduction

This menu can be used to configure a second set of parameters on the same soft starter.

It can be used to:

- Adapt the soft starter parameters to several loads on a single motor.
- Start and stop a two-speed motor.

The **[Type of stop]** set in **[Simply start]** applies to **[2nd Mot Assign]**.

NOTE: The Second Set of Motor Parameters function is not compatible with some functions. Refer to [Functions Compatibility Table](#), page 195 for more information.

Switching to the Second Set of Motor Parameters

When the 2nd set of motor parameters is selected, the changes are considered :

On next acceleration for:	On next deceleration for:
[Current Limit Motor 2]	[Type Of Stop Motor 2]
[Torque Limit Motor 2]	[Deceleration Motor 2]
[Nom Current Motor 2]	[Dec Gain Motor 2]
[Acceleration Motor 2]	[Freewheel level dec2]
[Init Start Torque Mot 2]	[DC Brake Time 2]
[Nom Power Motor 2]	[Braking Level Motor 2]
[Nom Speed Motor 2]	

Parameter description

Access path: [Complete settings] → [2nd Mot Parameters]

Description	Setting range	Factory setting																																				
[2nd Mot Assign] LIS	–	[Not Assigned] NO																																				
<p>Second motor selection assignment</p> <p>Assign a digital or virtual input to start the second set of motor parameters.</p> <ul style="list-style-type: none"> • [Not Assigned]: 1st set of motor parameters is used. • [DI●] : second set of motor parameters start assigned to digital input DI●. • [CD●●] : second set of motor parameters start assigned to line channel. Refer to the fieldbus manuals for the CMD word assignments. <p>At low level of the assigned input/bit, 1st set of motor parameters is used. At high level , 2nd set of motor parameters is used.</p> <p>NOTE: The switch between the 2 sets of motor parameters, must only be done at standstill.</p>																																						
[2nd Motor Usage] LISC	[2 Applications] 2APP or [2-Speed Motor] 2SPD	[2-Speed Motor] 2SPD																																				
<p>2nd motor usage selection</p> <p>This parameter can be set to:</p> <ul style="list-style-type: none"> • [2 Applications] : In the case of an application where the load changes. It allows to optimize the starting and stopping process for “low” load case and “high” load case. • [2-Speed Motor] : It allows to start and stop a 2–speed motor. Refer to the corresponding diagram. <table border="1" style="width: 100%; border-collapse: collapse;"> <thead> <tr> <th></th> <th>[2 Applications]</th> <th>[2-Speed Motor]</th> </tr> </thead> <tbody> <tr> <td>[Nom Current Motor 2]</td> <td>Forced to [Motor Nom Current].</td> <td>Modifiable</td> </tr> <tr> <td>[Nom Speed Motor 2]</td> <td>Forced to [Nominal Motor Spd].</td> <td>Modifiable</td> </tr> <tr> <td>[Nom Power Motor 2]</td> <td>Forced to [Nominal Motor Power]</td> <td>Modifiable</td> </tr> <tr> <td>[Current Limit Motor 2]</td> <td>Modifiable</td> <td>Modifiable</td> </tr> <tr> <td>[Init Start Torque Mot 2]</td> <td>Modifiable</td> <td>Modifiable</td> </tr> <tr> <td>[Acceleration Motor 2]</td> <td>Modifiable</td> <td>Modifiable</td> </tr> <tr> <td>[Type Of Stop Motor 2]</td> <td>Modifiable</td> <td>Forced to [Type of stop]</td> </tr> <tr> <td>[Deceleration Motor 2] + [Freewheel level dec2]</td> <td>Modifiable</td> <td>Modifiable</td> </tr> <tr> <td>[Dec Gain Motor 2]</td> <td>Modifiable</td> <td>Modifiable</td> </tr> <tr> <td>[DC Brake Time 2] + [Braking Level Motor 2]</td> <td>Modifiable</td> <td>Forced to [DC Braking Time] + [Braking Level]</td> </tr> <tr> <td>[Torque Limit Motor 2]</td> <td>Modifiable</td> <td>Modifiable</td> </tr> </tbody> </table>				[2 Applications]	[2-Speed Motor]	[Nom Current Motor 2]	Forced to [Motor Nom Current].	Modifiable	[Nom Speed Motor 2]	Forced to [Nominal Motor Spd].	Modifiable	[Nom Power Motor 2]	Forced to [Nominal Motor Power]	Modifiable	[Current Limit Motor 2]	Modifiable	Modifiable	[Init Start Torque Mot 2]	Modifiable	Modifiable	[Acceleration Motor 2]	Modifiable	Modifiable	[Type Of Stop Motor 2]	Modifiable	Forced to [Type of stop]	[Deceleration Motor 2] + [Freewheel level dec2]	Modifiable	Modifiable	[Dec Gain Motor 2]	Modifiable	Modifiable	[DC Brake Time 2] + [Braking Level Motor 2]	Modifiable	Forced to [DC Braking Time] + [Braking Level]	[Torque Limit Motor 2]	Modifiable	Modifiable
	[2 Applications]	[2-Speed Motor]																																				
[Nom Current Motor 2]	Forced to [Motor Nom Current].	Modifiable																																				
[Nom Speed Motor 2]	Forced to [Nominal Motor Spd].	Modifiable																																				
[Nom Power Motor 2]	Forced to [Nominal Motor Power]	Modifiable																																				
[Current Limit Motor 2]	Modifiable	Modifiable																																				
[Init Start Torque Mot 2]	Modifiable	Modifiable																																				
[Acceleration Motor 2]	Modifiable	Modifiable																																				
[Type Of Stop Motor 2]	Modifiable	Forced to [Type of stop]																																				
[Deceleration Motor 2] + [Freewheel level dec2]	Modifiable	Modifiable																																				
[Dec Gain Motor 2]	Modifiable	Modifiable																																				
[DC Brake Time 2] + [Braking Level Motor 2]	Modifiable	Forced to [DC Braking Time] + [Braking Level]																																				
[Torque Limit Motor 2]	Modifiable	Modifiable																																				
[Nom Speed Motor 2] NMS2	[Same As Mains]; 33...10000 rpm	[Same As Mains] AUTO																																				
<p>Nominal speed Motor 2</p> <p>This parameter can be accessed if [2nd Mot Assign] is assigned and [2nd Motor Usage] is set to [2-Speed Motor].</p> <p>For more information about Nominal motor speed, refer to Set Motor Nameplate Parameters, page 151.</p>																																						

Description	Setting range	Factory setting
[Nom Power Motor 2] <i>NPM2</i>	70...1840 In (kW or HP)	[Same As Mains] <i>AUTO</i>
<p>Nominal power Motor 2</p> <p>This parameter can be accessed if [2nd Mot Assign] is assigned and [2nd Motor Usage] is set to [2-Speed Motor].</p> <p>For more information about Nominal motor power, refer to Set Motor Nameplate Parameters, page 151.</p>		
[Nom Current Motor 2] <i>INM2</i>	—	(1)
<p>Motor 2 nominal current</p> <p>This parameter can be accessed if [2nd Mot Assign] is set to digital or a virtual input and [2nd Motor Usage] is set to [2-Speed Motor].</p> <p>For more information about Nominal current, refer to Set the Current & Current Limitation, page 122.</p> <p>(1) Factory setting of [Motor Nom Current] corresponding to the usual value of a 4-pole 400 V standardized induction motor and [Inside Delta] is set to [No] (soft starter connected in-line).</p>		
[Current Limit Motor 2] <i>ILM2</i>	150...500%	400% of [Motor Nom Current] <i>IN</i>
<p>Motor 2 current limit</p> <p>This parameter can be accessed if [2nd Mot Assign] <i>LIS</i> is set to digital or a virtual input.</p> <p>For more information about Motor limiting current, refer to Set the Current & Current Limitation, page 122</p>		
[Acceleration Motor 2] <i>ACM2</i>	1...60 s	15 s
<p>Motor 2 acceleration time</p> <p>For more information about Acceleration ramp time, refer to Start and Stop, page 164</p>		
[Init Start Torque Mot 2] <i>TQM2</i>	0...100% of nominal torque	20%
<p>Motor 2 initial starting torque</p> <p>Initial torque setting during the starting phase. If set too low, the motor may not start as soon as the RUN command is applied.</p> <p>[Init Start Torque Mot 2] cannot be higher than [Torque Limit Motor 2].</p> <p>This parameter can be accessed if:</p> <ul style="list-style-type: none"> • [2nd Mot Assign] is set to digital or a virtual input. • [Control Mode] is set to [Torque Control]. <p>For more information about Initial starting torque refer to Set Start Profile, page 124.</p>		
[Deceleration Motor 2] <i>DEM2</i>	1...60 s	15 s
<p>Motor 2 deceleration time</p> <p>This parameter can be accessed if:</p> <ul style="list-style-type: none"> • [2nd Mot Assign] is set to digital or a virtual input. • [Type Of Stop Motor 2] is set to [Deceleration]. <p>For more information about Deceleration ramp time, refer to Start and Stop, page 164.</p>		

Description	Setting range	Factory setting
[End Of Dec Motor 2] EDM2	0...100% of estimated torque when a Stop order is applied	20%
<p>Motor 2 end of controled deceleration threshold</p> <p>As soon as the estimated torque is below the value set in [End Of Dec Motor 2], the motor stops in freewheel.</p> <p>This parameter can be accessed if:</p> <ul style="list-style-type: none"> • [2nd Mot Assign] is set to digital or a virtual input. • [Type Of Stop Motor 2] is set to [Deceleration]. • [Control Mode] is set to [Torque Control]. <p>For more information about End of controled deceleration threshold refer to Set Stop Profile, page 125.</p>		
[Torque Limit Motor 2] TLM2	10...200% of nominal torque or [No] NO	[No] NO
<p>Motor 2 torque limit</p> <p>This parameter can be used to:</p> <ul style="list-style-type: none"> • Limit torque reference during deceleration in case of high inertia application. • Provide constant torque during acceleration if [Init Start Torque Mot 2] is equal to [Torque Limit Motor 2] <p>This parameter can be accessed if:</p> <ul style="list-style-type: none"> • [2nd Mot Assign] is set to digital or a virtual input. • [Control Mode] is set to [Torque Control]. <p>For more information about Torque limit refer to Start and Stop, page 164.</p>		
[Dec Gain Motor 2] TIM2	10...50 %	40 %
<p>Motor 2 torque control deceleration gain</p> <p>This parameter reduces instability during deceleration.</p> <p>This parameter can be accessed if:</p> <ul style="list-style-type: none"> • [2nd Mot Param Set] is set to digital or a virtual input. • [Type Of Stop Motor 2] is set to [Deceleration]. • [Control Mode] is set to [Torque Control] <p>For more information about Torque control deceleration gain, refer to Start and Stop, page 164.</p>		
[Type Of Stop Motor 2] STM2	-	[Freewheel] F
<p>Stop mode Motor 2</p> <p>This parameter can be accessed if [2nd Mot Param Set] is set to digital or a virtual input.</p> <p>If [2nd Motor Usage] is set to [2-Speed Motor], [Type Of Stop Motor 2] configuration follows [Type of stop] configuration.</p> <p>If [2nd Motor Usage] is set to [2 Applications], [Type Of Stop Motor 2] setting range is:</p> <ul style="list-style-type: none"> • [Freewheel] • [Deceleration] • [Braking] <p>For more information about Type of stop, refer to Set Stop Profile, page 125.</p>		
[DC Brake Time 2] EBM2	20...100%	20%
<p>DC continuous braking time Motor 2</p> <p>This parameter can be accessed if:</p> <ul style="list-style-type: none"> • [2nd Mot Param Set] is set to digital or a virtual input. • [Type Of Stop Motor 2] is set to [Braking]. <p>For more information about DC continuous braking time, refer to Set Stop Profile, page 125.</p>		

Description	Setting range	Factory setting
[Braking Level Motor 2] <i>BRM2</i>	0...100%	50%
<p><i>Dynamic braking level Motor 2</i></p> <p>This parameter can be accessed if:</p> <ul style="list-style-type: none"> • [2nd Mot Param Set] is set to digital or a virtual input. • [Type Of Stop Motor 2] is set to [Braking]. <p>For more information about <i>Dynamic braking level</i>, refer to Set Stop Profile, page 125.</p>		
[Freewheel level dec2] <i>EVM2</i>	0...100%	20%
<p><i>Threshold for changing to freewheel stop in voltage control Motor 2</i></p> <p>This parameter can be accessed if:</p> <ul style="list-style-type: none"> • [Type Of Stop Motor 2] is set to [Deceleration]. • [Control Mode] is set to [Voltage Control] <p>For more information about <i>Threshold for changing to freewheel stop in voltage control</i>, refer to Start and Stop, page 164.</p>		

Functions Compatibility Table

The choice of application functions can be limited by the incompatibility between certain functions. The functions that are not listed in the table below are not incompatible with any other functions.

	Functions A and B can be configured at the same time
X	Function A cannot be activated. Function A is incompatible with the function B .
D	Function A can be activated but deactivate the function B . Function A has priority.
	Not reachable

Function B (already activated) →	[Braking]	[Phase Loss Monit]	[Inside Delta]	[Small Motor Test]	[Preheating Assign]	[Torque Control]	[2nd Mot Parameters]	[Time Before Starting]	[Current Limit Motor 2]	[Jog Assign]	[Gamma Sync Enable]	[Start pump trajectory]	[Anti-Jam]	[Disable Error Detect]
Function A (to be activated) ↓														
[Braking]			X											
[Phase Loss Monit]				X (1)										
[Inside Delta]	D												X	
[Small Motor Test]		D (1)			D	D (2)				X	D (3)		X	
[Preheating Assign]				X				X (4)					X	
[Torque Control]				X (2)								D		
[2nd Mot Parameters]								D	X			X	X	
[Time Before Starting]					X (4)		X							
[Current Limit Motor 2]							X							
[Jog Assign]				X									X	
[Gamma Sync Enable]				X (3)										
[Start pump trajectory]						X	X							
[Anti-Jam]			X	X	X		X			X				X
[Disable Error Detect]													X	

1. During small motor test, output phase loss is deactivated and its value configured before activation of small motor test is recovered once small motor test is deactivated.
2. During small motor test, only voltage control is considered whatever configuration of **[Control Mode]** before activation of small motor test. **[Control Mode]** configuration before activation of small motor test is recovered once small motor test is deactivated.
3. During small motor test, **[Gamma Sync Enable]** is deactivated and its value configured before activation of small motor test is recovered once small motor test is deactivated.
4. **[Time Before Starting]** T_{HTR} uses the internal thermal estimation, an external thermal sensor should be used to monitor the temperature of the motor.

Additionally, it is not possible to use:

- **[Fwd/Rev by Contactor]** function in **[2/3-Wire Control]** set to **[Hardwired ctrl mode]**.
- **[Forced Local]** function in **[Control Mode]** set to **[I/O profile]**.
- **[Device Lock]** sub-function without using **[Mains Contactor]** function.
- Anti-jam automatic trigger (**[Anti-Jam Auto Trig]**) without **[Process overload]** function.

It is recommended to use **[Fwd/Rev by Contactor]** function with **[Mains Contactor]** function.

[Fwd/Rev by Contactor] function gives over possibilities on **[Forced Run]**, **[Jog]** and **[Anti-Jam]** functions. Refer to each function for more information.

Command Channel

This chapter describes the way to command the soft starter using physical channels such as terminals, Graphic Display Terminal, fieldbus and others.

Access path: **[Complete settings] → [Command channel]**

Configuration

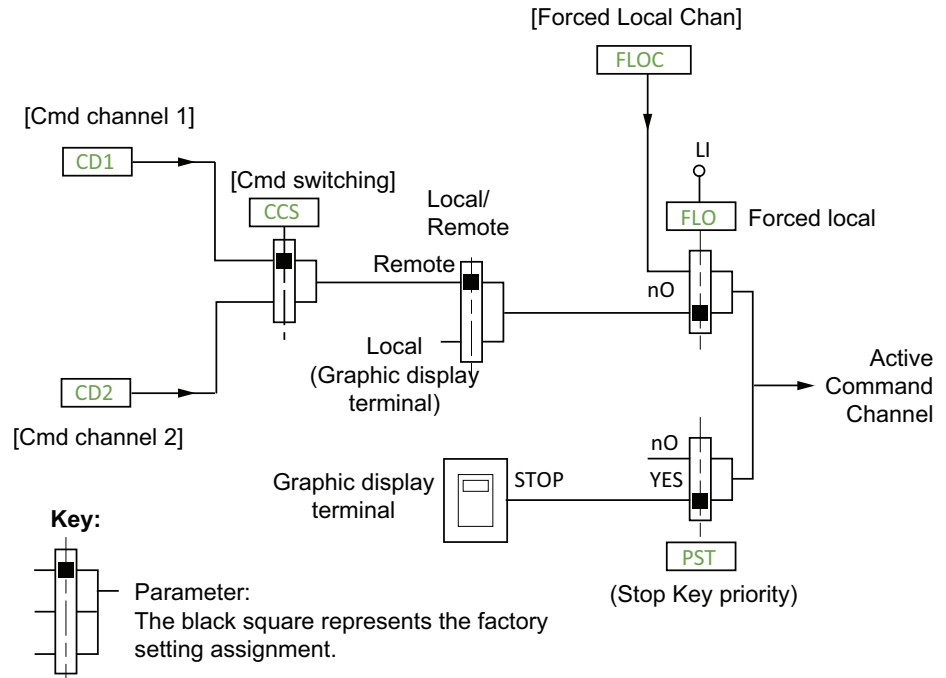



NOTE: If a **Stop command** is applied via a channel different from the active command channel, the motor stops in freewheel and can only be powered again by removing the active **Run command** and applying a new one.

NOTE: A function assigned to [CD●●] cannot be enabled/disabled when [HMI] is the **Active Command Channel**. Refer to fieldbus manual for more information.

NOTE: If fieldbus is the active command channel, and [2/3-Wire Control] = [3-Wire Control] or [Hardwired ctrl mode], DI1 should be put at high level.

HMI label	Setting	Factory setting
[Control Mode]  CHCF	—	[Standard Profile] STD
Control mode configuration		
<p>This parameter is relevant if the soft starter is used with a fieldbus.</p> <ul style="list-style-type: none"> Set [Control Mode] to [Standard Profile]. This profile is based on the CiA402, which has been adapted to the characteristics of the Altivar Soft Starter and therefore to all communication ports. Set [Control Mode] to [I/O profile]. This profile, supported by all channel commands excepted display command, mirrors the use of the terminal by allowing to use 1 bit of command register to activate a function. 		
⚠ WARNING		
UNANTICIPATED EQUIPMENT OPERATION		
<p>Disabling [I/O profile] IO resets the device to the factory settings.</p> <ul style="list-style-type: none"> Verify that restoring the factory settings is compatible with the type of wiring used. <p>Failure to follow these instructions can result in death, serious injury, or equipment damage.</p>		

HMI label	Setting	Factory setting
[Command Switching] 	-	[Cmd channel 1] CD1
Command switching		
<div style="border: 1px solid black; padding: 10px;"> <h2 style="margin: 0;">⚠ WARNING</h2> <h3 style="margin: 5px 0 0 0;">UNANTICIPATED EQUIPMENT OPERATION</h3> <p style="margin: 5px 0 0 0;">This parameter can cause unintended movements, for example, inversion of the direction of rotation of the motor, sudden acceleration or stops.</p> <ul style="list-style-type: none"> Verify that the setting of this parameter does not cause unintended movements. Verify that the setting of this parameter does not result in unsafe conditions. <p style="margin: 5px 0 0 0;">Failure to follow these instructions can result in death, serious injury, or equipment damage.</p> </div>		
<p>This parameter sets which channel takes the command of the soft starter.</p> <ul style="list-style-type: none"> [Cmd channel 1] : Command channel defined via Command channel 1 assign. [Cmd channel 2] : Command channel defined via Command channel 2 assign. [DI●] : Command channel switching assigned to digital input. [Cy●●] : Command channel switching assigned to line channel. <p>When assigned to a digital input or a bit:</p> <ul style="list-style-type: none"> [Cmd channel 1] active at low level. [Cmd channel 2] active at high level. 		
[Cmd channel 1] CD1	-	[Terminal] TER
Command channel 1 assign <p>This parameter sets the active command channel for [Cmd channel 1].</p> <ul style="list-style-type: none"> [Terminal]: command with the digital inputs. [HMI]: command with the display terminal. [Embd Mdb]: command with the embedded Modbus. [CANopen]: command with the plugged CANopen fieldbus module. [Com. Module]: command with the plugged fieldbus module. [Embd Eth]: command with the embedded Ethernet. 		
[Cmd channel 2] 	-	[Embd Mdb] MDB
Command channel 2 assign <p>This parameter sets the active command channel for [Cmd channel 2].</p> <ul style="list-style-type: none"> [Terminal]: command with the digital inputs. [HMI]: command with the display terminal. [Embd Mdb]: command with the embedded Modbus. [CANopen]: command with the plugged CANopen fieldbus module. [Com. Module]: command with the plugged fieldbus module. [Embd Eth]: command with the embedded Ethernet. 		

HMI label	Setting	Factory setting
[Copy Ch1-Ch2]  COP	–	[No] NO
<p>Copy Ch.1-Ch.2</p> <p>This parameter copies the channel command configuration.</p> <ul style="list-style-type: none"> • [No]: No copy. • [Command]: Copy the command words from channel 1 to channel 2 in [Standard Profile] and in both directions in [I/O profile]. <p>NOTE: A command cannot be copied from a channel on terminals.</p>		
<h2>▲ WARNING</h2>		
<p>UNANTICIPATED EQUIPMENT OPERATION</p> <p>This parameter can cause unintended movements, for example, inversion of the direction of rotation of the motor, sudden acceleration or stops.</p> <ul style="list-style-type: none"> • Verify that the setting of this parameter does not cause unintended movements. • Verify that the setting of this parameter does not result in unsafe conditions. <p>Failure to follow these instructions can result in death, serious injury, or equipment damage.</p>		
[2/3-Wire Control] TCC	–	[2-Wire Control] 2C
<p>2/3-wire control</p> <p>This parameter can be set to :</p> <ul style="list-style-type: none"> • [2-Wire Control] : Only one digital input needed for Run and Stop management. • [3-Wire Control] : Run and Stop are controlled by 2 different digital inputs. • [Hardwired ctrl mode] : This mode depends on the 2 or 3 legacy wiring. <p>For further explanation, refer to Set Type of Wire Control, page 121.</p>		
[2-wire type] TCT	–	[Transition] TRN
<p>Type of 2-wire control</p> <p>This parameter can be set to :</p> <ul style="list-style-type: none"> • [Level] : State 0 or 1 is taken into account for run (1) or stop (0) • [Transition] : A change of state (transition or edge) is necessary to initiate operation in order to avoid accidental restarts after a break in the supply mains <p>For further explanation, refer to Set Type of Wire Control, page 121.</p>		
[Reverse Assign] RRS	–	[Not Assigned] NO
<p>Reverse assignment</p> <p>For further explanation, refer to Reverse by External Contactor , page 179.</p>		
[Forced Local Assign] FLO	–	[Not Assigned] NO
<p>Forced local assignment</p> <p>This parameter forces the local channel set by [Forced Local Chan]. When the forced local channel is activated, the soft starter is stopped following the type of stop set by [Type of stop] if a Run command is not active on the forced channel and all the parameter write requests coming from fieldbus are rejected.</p> <p>NOTE: [Forced Local] is not compatible with [Control Mode] set to [I/O profile].</p> <p>[Forced Local Assign] is active when a high level is applied to the set digital input.</p> <ul style="list-style-type: none"> • [Not Assigned] : No digital input set. • [DI•] : Forced local assignment set to digital input on high level, this setting assign also the digital input to [Forced Local]. 		

HMI label	Setting	Factory setting
[Forced Local Chan] FLOC	–	[Terminal] TER
<p>Forced Local channel assignment</p> <p>This parameter set which local channel is used at the activation of the digital input set in [Forced Local Chan].</p> <ul style="list-style-type: none"> [Terminal] : Forced local channel are the digital inputs. [HMI] : Forced local channel is forced to display terminal. <p>This parameter is visible only if [Forced Local Assign] is configured.</p>		
[Time-out forc. local] FLOT	0.1...30.0 s	10.0 s
<p>Time-out forc. local</p> <p>Time-out to confirm a new channel command after forced local deactivation.</p> <p>This parameter is visible only if [Forced Local Assign] is configured.</p> <p>At exit of forced local, in case of communication interruption, the active channel remains the forced channel until [Time-out forc. local] is expired. Without any new command coming from the channel command, the device will trigger an error depending on the fieldbus used.</p>		

Input/Output Assignment

What's in This Chapter

Digital Inputs Assignment..... 202
 DQ1 & DQ2 Configuration..... 204
 AI1 Configuration 206
 AQ1 Configuration..... 207
 R1 Configuration 209
 R2 and R3 Configuration..... 210

This menu manages the assignments of the digital inputs, digital outputs, analog inputs, analog outputs and relays.

NOTE: For more information on how outputs behave when using communication, please refer to the related communication guides.

Digital Inputs Assignment

Low Assignment

Those parameters provide the possible low assignment to the digital inputs.

Access path: **[Input/Output]**

Description	Setting range	Factory setting
[DI1 Low Assign] L1L [DI2 Low Assign] L2L [DI3 Low Assign] L3L [DI4 Low Assign] L4L	-	[No]

DI1 low assignment & DI2 low assignment & DI3 low assignment & DI4 low assignment

Those parameters assign a function to the digital inputs.

Only one function can be assigned at any moment. If you assign a new function to an already assigned digital input, the previous function assigned to this digital input will be deactivated.

Unless specified otherwise, the following assignments are active when a low level is applied.

- **[No]:** Digital input not assigned.
- **[Freewheel Stop]:** *Freewheel stop*.
- **[External Error]:** Allows the device to trigger an external user error (level, pressure, ...). The external error can trigger on a high or low level, set by **[Ext Error Condition]**.
Automatic assignment: **[Ext Error assign]** set to digital input.

- **[Disable Error Detect]:** Inhibits error detection. The soft starter records the detected errors but doesn't stop running.
Automatic assignment: **[Disable Error Detect]** set to digital input, for the mandatory safety measures refer to Smoke Extraction, page 174.

⚠ WARNING

UNANTICIPATED EQUIPMENT OPERATION

If **[Disable Error Detect] INH** is set to a digital input active at low level and **[Forced Run] INHS** is enabled, you must ensure that the digital input is wired and inactive when the configuration is done and/or applied.

Failure to follow these instructions can result in death, serious injury, or equipment damage.

- **[Device Lock]:** Forces open the relay assigned to **[Mains Contactor]**.
Automatic assignment: **[Device Lock]** set to digital input.

NOTE: **[DI1 Low Assign]** is forced to **[Freewheel Stop]** in **[I/O profile]** if **[2/3-Wire Control]** is set to **[3-Wire Control]** or **[Hardwired ctrl mode]**.

High Assignment

Those parameters provide the possible high assignment to the digital inputs.

Access path: **[Input/Output]**

Description	Setting range	Factory setting depending if [2/3-Wire Control] is set to:	
		[3-Wire Control] or to [Hardwired ctrl mode]	[2-Wire Control]
[DI1 High Assign] L1H	-	[Run]	[Forward]
[DI2 High Assign] L2H	-	[Forward]	[No]
[DI3 High Assign] L3H [DI4 High Assign] L4H	-	[No]	[No]

DI1 high assignment & DI2 high assignment & DI3 high assignment & DI4 high assignment

Those parameters assign a function to the digital inputs.

Only one function can be assigned at any moment. If you assign a new function to an already assigned digital input, the previous function assigned to this digital input will be deactivated.

Unless specified otherwise, the following assignments are active when a high level is applied.

- **[No]**: Digital input not assigned.
- **[Run]**: *Run* (if a DI is assigned to this setting, it cannot be modified).
- **[Forward]**: *Forward direction select* (if a DI is assigned to this setting, it cannot be modified).
- **[Reverse]**: *Reverse direction*.
- **[Jog]**: *Jog*.
- **[Forced Local]**: Forces the local channel set by **[Forced Local Chan]**. Automatic assignment: **[Forced Local Assign]** set to digital input.
- **[Fault Reset]**: Resets the device to clear a detected error after removing its cause.
- **[External Error]**: Allows the device to trigger an external user error (level, pressure, ...). The external error can trigger on a high or low level, set by **[Ext Error Condition]**.

Automatic assignment: **[Ext Error assign]** set to digital input.

- **[Cmd switching]** : Sets the active command channel (**[Cmd channel 1]** active at low level or **[Cmd channel 2]** active at high level).

This function can be assigned only via the parameter **[Command Switching]** in the menu **[Complete settings]** → **[Command channel]**.

This function cannot be assigned via the menu **[Input/Output]**. If **[Command Switching]** is assigned to a digital input, it is necessary to remove first this assignation via the parameter before assigning the digital input to a new function.

- **[Disable Error Detect]**: Inhibits error detection. The soft starter records the detected errors but doesn't stop running.

Automatic assignment: **[Disable Error Detect]** set to digital input, for the mandatory safety measures refer to Smoke Extraction, page 174.

⚠ WARNING

UNANTICIPATED EQUIPMENT OPERATION

If **[Disable Error Detect] INH** is set to a digital input active at low level and **[Forced Run] INHS** is enabled, you must ensure that the digital input is wired and inactive when the configuration is done and/or applied.

Failure to follow these instructions can result in death, serious injury, or equipment damage.



- **[Product Restart]**: *Product restart*.
- **[Jog Slow Speed]**: *Jog slow speed*.
- **[Boost]**: *Voltage boost*. Automatic assignment: **[Boost Assign]** set to digital input.
- **[Ext Anti-Jam trig]**: *External Anti-Jam trigger*.
- **[2nd Mot Param Set]**: Applies the second set of parameters. Automatic assignment: **[2nd Mot Assign]** set to digital input.
- **[Preheating]**: Starts the preheating. Automatic assignment: **[Preheating Assign]** set to digital input.
- **[Ext Curr Limit Active]**: *External Current limitation Activation*. Automatic assignment: **[Ext Curr Lim Assign]** set to digital input.

DQ1 & DQ2 Configuration

These menus provide the parameters to assign a function to the digital outputs DQ1 or DQ2 and to set its active level.

Access path: **[Input/Output] → [DQ1 configuration] OR [DQ2 Configuration]**

Description	Setting range	Factory setting
[DQ1 Assignment] DO1	–	[Motor Overload Warn] OLMA
[DQ2 Assign] DO2	–	[Device Running] RUN
<p>DQ1 assignment OR DQ2 assignment</p> <p>This parameter sets the condition to activate DQ1 or DQ2:</p> <ul style="list-style-type: none"> • [Not Assigned]: Digital output not assigned. • [Operating State Fault]: <i>Device in operating state "Fault"</i>. <ul style="list-style-type: none"> ◦ 0> device in error or A1/A2 is not supplied ◦ 1> device is not in error and A1/A2 are supplied. • [Device Running] • [Dev Th reached]: <i>Device thermal threshold reached</i>. • [Proc Undld Warn]: <i>Process underload warning</i>. • [Proc Overload Warn] • [Forced Run] • [Run Forward]: output to 1 when the motor is in forward run. • [Run Reverse]: output to 1 when the motor is in reverse run. • [Curr Limit Switch]: <i>Current limitation switching state</i> linked to Set Second Current Limitation, page 153. • [HMI L/R cmd]: Control via the display terminal is active (only active with Local/Remote button). • [Power Removal State]: it gives the information about STO input status but only in 230v (A1/A2) supply. • [Warning Grp 1] or [Warning Grp 2] or [Warning Grp 3] or [Warning Grp 4] or [Warning Grp 5]. • [Ext Error Warn] • [UnderV Warn] • [Device Th Warn]: <i>Device thermal state warning</i>. • [Ready]: Ready to start. • [Pump Cycle Warn] • [Anti-Jam Warning]: <i>Anti-Jam warning</i> • [Jog Active] • [Inhibited Errors]: The digital input set to [Disable Error Detect] is active. • [Motor Overload Warn]: <i>Motor overload warning</i>. • [2nd Mot Param Active]: <i>second set of motor parameters activated</i>. • [End Of Start] • [Mains Loss Warn]: <i>Mains phase loss warning</i> • [Out Phase Loss] • [Overvoltage] • [Mains Unbalance] • [Curr Unbal Warn]: <i>Current unbalance warning</i> • [Temp Sens A11 Warn]: Thermal sensor not operating correctly. • [A11 Th Warning]: Thermal warning set by [A11 Th Warn Level] is active. • [Per Type of Stop]: Stop according to [Type of stop] parameter without triggering an error. 		

Description	Setting range	Factory setting
 [DQ1 Delay time] DO1D OR [DQ2 Delay time] DO2D	0...60000 ms	0 ms
<p>DQ1 delay time OR DQ2 delay time</p> <p>NOTE: If [DQ1 Assignment] (or [DQ2 Assign]) is set to :</p> <ul style="list-style-type: none"> • [End Of Start] • [Mains Contactor] • [Operating State Fault] • [Fwd/Rev by Contactor] <p>[DQ1 Delay time] (or [DQ2 Delay time]) is fixed on 0.</p>		
 [DQ1 Active at] DO1S OR [DQ2 Active at] DO2S	[High Level] POS or [Low Level] NEG	[High Level] POS
<p>DQ1 active level OR DQ2 active at</p> <p>This parameter sets the level applied by DQ1 or DQ2.</p> <ul style="list-style-type: none"> • [High Level]: Output applies a high level. • [Low Level]: Output applies a low level. <p>NOTE: If [DQ1 Assignment] (or [DQ2 Assign]) is set to :</p> <ul style="list-style-type: none"> • [End Of Start] • [Mains Contactor] • [Operating State Fault] • [Fwd/Rev by Contactor] <p>[DQ1 Active at] (or [DQ2 Active at]) is fixed on [High Level].</p>		
 [DQ1 Holding time] DO1H OR [DQ2 Holding time] DO2H	0...9999 ms	0 ms
<p>DQ1 holding time OR DQ2 holding time</p> <p>NOTE: If [DQ1 Assignment] (or [DQ2 Assign]) is set to :</p> <ul style="list-style-type: none"> • [End Of Start] • [Mains Contactor] • [Operating State Fault] • [Fwd/Rev by Contactor] <p>[DQ1 Holding time] (or [DQ2 Holding time]) is fixed on 0.</p>		

AI1 Configuration

[AI1 configuration] provides the parameters to assign a thermal sensor to the analog input AI1/PTC1 and to set a filter on this input.

Access path: **[Input/Output] → [AI1 configuration]**

The following diagram explains how the analog input works:

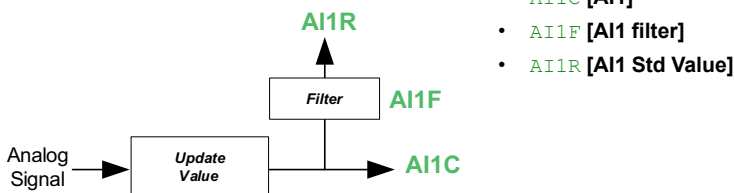

Description	Setting range	Factory setting
[AI1 assignment] AI1A	[No] or [AI1 Th Monitoring] TH1S	[No]
<p>AI1 assignment</p> <p>This parameter activates the thermal sensor monitoring on the terminal PTC1/AI1.</p> <ul style="list-style-type: none"> [No]: No function assigned to the terminal PTC1/AI1. [AI1 Th Monitoring]: Thermal monitoring on PTC1/AI1 terminal assigned and active with a thermal sensor and triggers an error on overheating detection. This allows to take the measured temperature on the motor into account for overheating detection. <p>NOTE:</p> <p>[AI1 Th Monitoring] cannot be assigned via [AI1 assignment] in the menu [Input/Output]. [AI1 Th Monitoring] can be assigned only via the parameter in the menu [Monitoring] → [Thermal monitoring].</p>		
[AI1 Type] AI1T	-	[Not Configured]
<p>Configuration of AI1</p> <p>This parameter sets the type of thermal sensors wired to PTC1/AI1.</p> <ul style="list-style-type: none"> [PTC]: 1 to 6 PTC in serial is used. [KTY]: 1 KTY sensor connected with 2 wires is used. [PT1000]: 1 PT1000 connected with 2 wires is used. [PT100]: 1 PT100 connected with 2 wires is used. [PT1000 in 3 wires]: 1 PT1000 connected with 3 wires is used. [PT100 in 3 wires]: 1 PT100 connected with 3 wires is used. [Not Configured]: Not Configured <p>NOTE: This parameter is accessible only if [AI1 assignment] is not set to [No].</p>		
 [AI1 filter] AI1F	0...10.00 s	0.00 s
<p>AI1 filter</p> <p>This parameter sets the cutoff time of the low filter for PTC1/AI1.</p> <p>The low pass filter aims to suppress electrical noise and avoid interference issue in the input signal.</p> <p>NOTE: This parameter is accessible only if [AI1 assignment] is not set to [No].</p>		
[AI1 Std Value] AI1R	-	-
<p>Analog input 1 standardized value</p> <p>Real image of each AI consumed by functions is available via [AI1 Std Value] AI1R.</p> <p>NOTE: this parameter is only accessible through the communication.</p> <p>NOTE: if a thermal sensor is used, [AI1 Th Value] TH1V is linked to AI1R.</p>		

AQ1 Configuration

This menu can be used to set the characteristics of the image of the signal sent by AQ1.

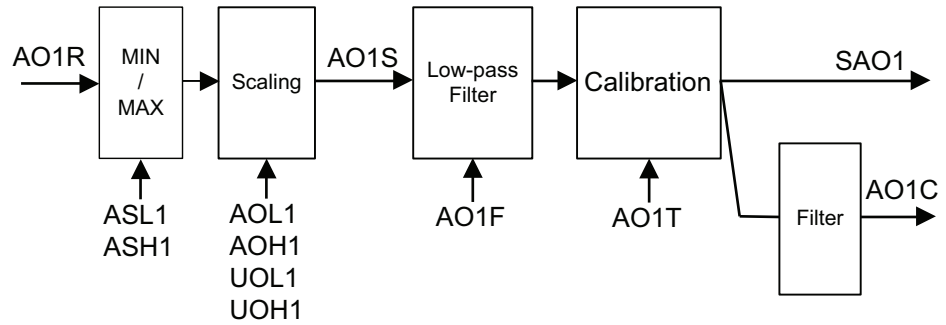

- AO1R [AO1 Std Value]
- ASL1 [Scaling AQ1 Min]
- ASH1 [Scaling AQ1 Max]
- AOL1 [AQ1 min output]
- AOH1 [AQ1 max output]
- UOL1 [AQ1 min Output]
- UOH1 [AQ1 max Output]
- AO1S [AQ1 Scaling]
- AO1F [AQ1 Filter]
- AO1T [AQ1 Type]
- SAO1 [AO1 Phy Val w/o Filter]
- AO1C [AQ1]

Access path: [Input/Output] → [AQ1 configuration]

Description	Setting range	Factory setting
[AQ1 assignment] AO1	–	[Motor Current] OCR
AQ1 assignment This parameter sets the characteristics of the image of the signal sent by AQ1. <ul style="list-style-type: none"> • [Not Configured]: <i>Not configured.</i> • [Motor Current]: <i>Motor current.</i> • [Mot Mech Pwr %]: <i>Motor power in %.</i> • [Mot Thermal]: <i>Motor thermal state.</i> • [Power Factor]: <i>Power factor.</i> • [Motor Torque]: <i>Motor torque.</i> • [Reactive Power]: <i>Reactive Electrical input power.</i> 		
[AQ1 Scaling] AO1S	50...700 %	200 %
Analog output AQ1 scaling This parameter sets the scaling of the maximum of AQ1 real image. If [AQ1 assignment] is set to [Power Factor] , [AQ1 Scaling] is forced to 100%. If [AQ1 assignment] is set to [Mot Thermal] , [AQ1 Scaling] is forced to 300%.		

Description	Setting range	Factory setting
[AQ1 Type] AO1T	[Voltage] 10U or [Current] 0A	[Current] 0A
<p>AQ1 Type</p> <p>This parameter sets the type of signal applied by AQ1.</p> <ul style="list-style-type: none"> [Voltage]: 0...10 Vdc. [Current]: 0...20 mA. 		
[AQ1 min output] AOL1	0...20 mA	0 mA
[AQ1 min Output] UOL1	0...10 V	0 V
<p>AQ1 min output value and AQ1 minimum output</p> <p>This parameter sets the minimum value applied by AQ1.</p> <p>NOTE: About AOL1, to comply with analog output 4...20 mA, set [AQ1 min output] to 4.</p> <p>[AQ1 min output] accessible only if [AQ1 Type] is set to [Current].</p> <p>[AQ1 min Output] accessible only if [AQ1 Type] is set to [Voltage].</p>		
[AQ1 max output] AOH1	0...20 mA	20 mA
[AQ1 max Output] UOH1	0...10 V	10 V
<p>AQ1 max output value and AQ1 maximum output</p> <p>This parameter sets the maximum value applied by AQ1.</p> <p>[AQ1 max output] accessible only if [AQ1 Type] is set to [Current].</p> <p>[AQ1 max Output] accessible only if [AQ1 Type] is set to [Voltage].</p>		
[Scaling AQ1 Min] ASL1	0...100 %	0 %
[Scaling AQ1 Max] ASH1		100 %
<p>Scaling AQ1 min and Scaling AQ1 max</p> <p>These parameters set the minimum and the maximum scaling of the signal applied by AQ1.</p> <ul style="list-style-type: none"> If [Scaling AQ1 Min] is superior to [Scaling AQ1 Max], [Scaling AQ1 Min] is forced equal to [Scaling AQ1 Max]. If [Scaling AQ1 Max] is inferior to [Scaling AQ1 Min], [Scaling AQ1 Max] is forced equal to [Scaling AQ1 Min]. <div style="display: flex; align-items: flex-start;"> <div style="flex: 1;"> </div> <div style="flex: 1; margin-left: 20px;"> <ul style="list-style-type: none"> • S: Scaling • R: Real image • (a): [Scaling AQ1 Max] • (b): [Scaling AQ1 Min] </div> </div>		
[AQ1 Filter] AO1F	0...10 s	0 s
<p>AQ1 filter</p> <p>This parameter sets the cutoff time of the low filter.</p> <p>The low pass filter aims to suppress electrical noise and avoid interference issue in the output signal.</p>		

R1 Configuration

This menu provides the parameters to assign a function to the relay R1, to set its active level and holding time.

Access path: **[Input/Output] → [R1 configuration]**



Description	Setting range	Factory setting
[R1 Assignment] R1	—	[Operating State Fault] FLT
<p>R1 assignment</p> <p>This parameter assigns the condition for R1 to activate.</p> <ul style="list-style-type: none"> • [Not Assigned]: Relay not assigned. • [Operating State Fault]: R1 is closed when the soft starter is supplied and no error is detected. R1 is opened when an error is detected or when the soft starter control supply A1/A2 is not present. • [Mains Contactor]: R1 manages the mains power supply by controlling the line contactor. R1 closed = Power supply applied to the power section of the soft starter. 		

R2 and R3 Configuration

This menu provides the parameters to assign a function to the relay R2 and R3, to set its active level and holding time.

Access path: **[Input/Output] → [R2 configuration] / [R3 configuration]**

Description	Setting range	Factory setting
[R2 Assignment] <small>R2</small> [R3 Assignment] <small>R3</small>	–	[Not Assigned] <small>NO</small>
<p>R2 assignment and R3 assignment</p> <ul style="list-style-type: none"> • [Not Assigned]: Digital output not assigned. • [Operating State Fault]: <i>Device in operating state "Fault"</i>. • [Device Running] • [Proc Undld Warn]: <i>Process underload warning</i>. • [Proc Overload Warn] • [Forced Run] • [Run Forward] • [Run Reverse] • [Curr Limit Switch]: <i>Current limitation switching state</i> • [HMI L/R cmd]: Control via the display terminal is active (only active with Local/Remote button). • [Power Removal State] • [Mains Contactor] • [Warning Grp 1] or [Warning Grp 2] or [Warning Grp 3] or [Warning Grp 4] or [Warning Grp 5]. • [Ext Error Warn] • [UnderV Warn] • [Device Th Warn]: <i>Device thermal state warning</i>. • [Ready]: Ready to start. • [Anti-Jam Active]: <i>Anti-Jam active</i> • [Pump Cycle Warn] • [Anti-Jam Warning]: <i>Anti-Jam warning</i> • [Jog Active] • [Inhibited Errors]: The digital input set to [Disable Error Detect] is active. • [Motor Overload Warn]: <i>Motor overload warning</i>. • [2nd Mot Param Active]: <i>second set of motor parameters activated</i>. • [End Of Start] (only for R2). • [Mains Loss Warn]: <i>Mains phase loss warning</i> • [Fwd/Rev by Contactor] • [Out Phase Loss] • [Overvoltage] • [Mains Unbalance] • [Curr Unbal Warn]: <i>Current unbalance warning</i> • [Temp Sens AI1 Warn]: Thermal sensor not operating correctly. • [AI1 Th Warning]: Thermal warning set by [AI1 Th Warn Level] is active. • [Per Type of Stop]: Stop according to [Type of stop] parameter without triggering an error. 		

Description	Setting range	Factory setting
 [R2 Delay time] R2D [R3 Delay time] R3D	0...60000 ms	0 ms
<p>R2 delay time and R3 delay time</p> <p>This parameter sets the time delay for R2 or R3 after which the relay state will actually be activated.</p> <p>NOTE: If [R2 Assignment] (or [R3 Assignment]) is set to :</p> <ul style="list-style-type: none"> • [End Of Start] (only for R2) • [Mains Contactor] • [Operating State Fault] • [Fwd/Rev by Contactor] <p>R2 delay time (or [R3 Delay time]) is fixed on 0.</p>		
 [R2 Active at] R2S [R3 Active at] R3S	[High Level] POS or [Low Level] NEG	[High Level] POS
<p>R2 active level and R3 active level</p> <p>This parameter sets the level applied by R2 or R3 when activated.</p> <ul style="list-style-type: none"> • [High Level]: R2 (or R3) applies a high level when activated. • [Low Level]: R2 (or R3) applies a low level when deactivated. <p>NOTE: If [R2 Assignment] (or [R3 Assignment]) is set to :</p> <ul style="list-style-type: none"> • [End Of Start] (only for R2) • [Mains Contactor] • [Operating State Fault] • [Fwd/Rev by Contactor] <p>[R2 Active at] (or [R3 Active at]) is fixed on [High Level].</p>		
 [R2 Holding time] R2H [R3 Holding time] R3H	0...9999 ms	0 ms
<p>R2 holding time and R3 holding time</p> <p>This parameter sets the holding time delay for R2 or R3 after which the relay state will actually be changed when a state change is ordered.</p> <p>NOTE: If [R2 Assignment] (or [R3 Assignment]) is set to :</p> <ul style="list-style-type: none"> • [End Of Start] (only for R2) • [Mains Contactor] • [Operating State Fault] • [Fwd/Rev by Contactor] <p>R2 holding time ([R3 Holding time]) is fixed on 0.</p>		

Configuration Files Management

What's in This Part

Soft Starter Configuration files	213
Save & Restore a device configuration	214
Save & Restore a device image	215
Reset to Factory Settings	216
Product Restart	218
Soft starter firmware update	219
Option Modules Firmware update	222

Soft Starter Configuration files

In a soft starter, is called:

- A device configuration, a list of parameters settings in relation to the soft starter, the application, and the communication.
- A cybersecurity policy, containing all settings in relations with cybersecurity.
- A device image, regrouping the device configuration and cybersecurity policy.

Saving & Restoring Configuration, Backing up the device or doing a Factory settings will act differently on soft starter configuration files.

Save & Restore a device configuration

The device configuration can be saved on any Graphic Display Terminal. This function is used for cloning a soft starter or replacing a soft starter. The user has to ensure that the soft starter “source” and soft starter “destination” shall have the same product reference and the same topology (same option card if used, and same firmware).

Saving & restoring acts only on the device configuration file.

Access path: **[Device Management] → [Save/Load]**

HMI label	Setting	Factory setting
[Copy From Device] SAF	–	–
This allows to store the actual soft starter configuration into the Graphic Display Terminal. The number of configuration files store up are 16. The file name is configurable.		
[Copy To The Device] OPF	–	–
This allows to select a device configuration previously stored in the Graphic Display Terminal and apply it to the soft starter. The device needs to be restarted after a configuration file transfer.		

Saving a device configuration can also be done by:

- connecting the soft starter to SoMove and by saving a *.cfg file on your PC hard disk.
- connect the Graphic Display Terminal to the PC and transfer data by copy/paste.

Save & Restore a device image

The function is similar to Save and restore a device configuration, but it includes in addition the cybersecurity policy.

The device image can be saved on a Graphic Display Terminal (depending on the Graphic Display Terminal version).

Access path: **[Device Management]** → **[Save/Load]**

HMI label	Setting	Factory setting
[Save backup image] SBK	–	–
This parameter can be used to save the actual product configuration and cybersecurity policy into the Graphic Display Terminal.		
[Load backup image] OBK	–	–
This parameter can be used to select a product configuration and cybersecurity policy configuration previously stored in the Graphic Display Terminal and apply it to the soft starter.		

Saving a device image can also be done by connecting the soft starter to SoMove and by saving a *.bki file on your PC hard disk.

Reset to Factory Settings

What's in This Chapter

Proceed with a Manufacturer Factory settings 216
 Proceed with a User-Defined Factory settings 217

Access path: **[Device Management] → [Factory settings]**

Proceeding a factory settings aims to restore the original settings of the soft starter by erasing all modified parameters.

The soft starter offers 2 possibilities to restore the original settings:

- The Manufacturer Factory settings. Enabling this factory settings will copy the original configuration set defined by Schneider Electric, called "Macro Config" for which parameters will return to the default value. Default values can be overseen in the HMI navigation table, page 337.
- The User-defined Factory settings. The user will have the possibility to create his own original settings, select then apply them when doing a factory settings

For both factory settings:

- The function acts on the device configuration but does not erase logs and cybersecurity policy.
- The user can select all or partial device configuration to be restored.

Proceed with a Manufacturer Factory settings

NOTE: This procedure acts on Device Configuration only, while Cybersecurity Policy stays untouched.

Step	Action
1	<p>Select partial or complete settings to be restored.</p> <p>In the [Parameter group list] FRY menu, select the parameter to restore to the factory settings in the following list:</p> <ul style="list-style-type: none"> • [All] ALL : All parameters in all menus (except cybersecurity parameters). • [Device Configuration] DRM: Load [Complete settings] CST menu. • [Comm. menu] COM: Load embedded fieldbus menu. • [Display config.] DIS : Load display menu.
2	<p>Ensure that the [Config. Source] is the Manufacturer one, means [Macro Config] is checked.</p>
3	<p>Go to [Go to Factory Settings] GFS</p>
4	<p>The following safety message appears:</p> <div style="border: 1px solid black; padding: 10px; text-align: center;"> <p>⚠ WARNING</p> <p>UNANTICIPATED EQUIPMENT OPERATION</p> <ul style="list-style-type: none"> • Verify that restoring the factory settings or modifying the configuration is compatible with the type of wiring used. • If you are recalling a stored configuration, perform a comprehensive commissioning test to verify correct operation. <p>Failure to follow these instructions can result in death, serious injury, or equipment damage.</p> </div> <p>After reading this safety message, press OK (or ESC to exit).</p>
5	<p>The restoration is finished when the soft starter displays the previous menu.</p> <p>In factory configuration and after a return to "factory settings", [Parameter group list] FRY will be empty.</p>

Proceed with a User-Defined Factory settings

Maximum three customer parameter sets can be saved on the soft starter.

NOTE: .The **[Parameter group list] FRY** parameter has an impact on the saved customer configuration.

NOTE: This procedure acts on Device Configuration only, while Cybersecurity Policy stays untouched.

Save a configuration

Step	Action
1	In the [Save Configuration] SCS menu, select: <ul style="list-style-type: none"> • [Config 1] STR1 to store the customer parameters set 1. • [Config 2] STR2 to store the customer parameters set 2. • [Config 3] STR3 to store the customer parameters set 3.
2	To save, hold down the OK button until returned to the previous menu. The parameter changes back to [No] NO as soon as the operation is completed.

Restore a configuration

Step	Action
3	In the [Config. Source] FCS menu to recall a customer configuration, select device configuration previously saved in the following list: <ul style="list-style-type: none"> • [Macro Config] INI for the factory settings parameters set. • [Config 1] CFG1 for the customer parameters set 1. • [Config 2] CFG2 for the customer parameters set 2. • [Config 3] CFG3 for the customer parameters set 3.
4	Press OK to select the customer parameters to recall.
5	Select partial or complete settings to be restored. In the [Parameter group list] FRY menu, select the parameter to restore to the factory settings in the following list: <ul style="list-style-type: none"> • [All] ALL : All parameters in all menus (except cybersecurity parameters). • [Device Configuration] DRM: Load [Complete settings] CST menu. • [Comm. menu] COM : Load embedded fieldbus menu. • [Display config.] DIS : Load display menu.
6	Go to [Go to Factory Settings] GFS
7	The following safety message appears: <div style="border: 1px solid black; padding: 10px; margin: 10px 0;"> <p style="text-align: center;">⚠ WARNING</p> <p style="text-align: center;">UNANTICIPATED EQUIPMENT OPERATION</p> <ul style="list-style-type: none"> • Verify that restoring the factory settings or modifying the configuration is compatible with the type of wiring used. • If you are recalling a stored configuration, perform a comprehensive commissioning test to verify correct operation. <p style="text-align: center;">Failure to follow these instructions can result in death, serious injury, or equipment damage.</p> </div> After reading this safety message, press OK (or ESC to exit).
8	The restoration is finished when the soft starter displays the previous menu. In factory configuration and after a return to "factory settings", [Parameter group list] FRY will be empty.

Product Restart

This function has the same effect as switch off/on the control supply A1/A2 of the soft starter.

Access path:

- [Complete settings] → [Error/Warn handling]
- [Communication] → [Modbus Fieldbus]
- [Communication] → [Embd Eth Config]
- [Communication] → [CANopen]
- [Communication] → [Profibus]
- [Diagnostics]

HMI label	Setting	Factory setting
[Product restart] <small>RP</small>	–	[No]
<p>Product restart</p> <p>Manually restarts the soft starter via the HMI.</p> <p>This parameter is automatically set to [Not Assigned] after restart.</p> <ul style="list-style-type: none"> • [No]: No restart • [Yes] : Restart the soft starter. After select [Yes], this safety message is displayed: <p>The Restart function performs a Fault Reset and then restarts the device. During this Restart procedure, the device goes through the same steps as if it had been switched off and on again. Depending on the wiring and the configuration of the device, this may result in immediate and unanticipated operation.</p> <div style="border: 1px solid black; padding: 10px; text-align: center;"> <p>⚠ WARNING</p> <p>UNANTICIPATED EQUIPMENT OPERATION</p> <p>The Restart function performs a Fault Reset and restarts the device.</p> <ul style="list-style-type: none"> • Verify that activating this function does not result in unsafe conditions. <p>Failure to follow these instructions can result in death, serious injury, or equipment damage.</p> </div> <p>Confirm the message and the soft starter will restart.</p>		

Soft starter firmware update

Preparing soft starter for a firmware update

NOTE: Make sure that the latest version of the firmware and of the user manual are used.

NOTE: Make sure that the A1/A2 ports are supplied.

Install on your PC SoMove and the DTM.

To download the required DTM refer to ATS490: DTM, page 14.

To download SoMove go to SoMove FDT.

Connect the device to the PC. Use one of the following serial communication cables:

- VW3A8127 for Modbus VP12S connection.
- RJ45 cable for ethernet connection.

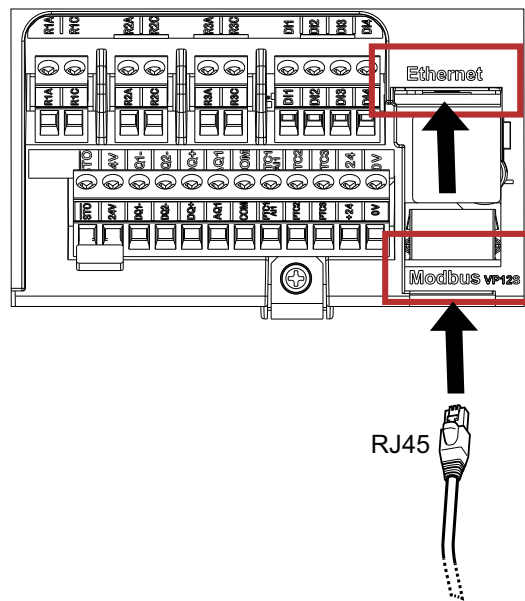

Download Altivar Soft Starter firmwares.

You can also request the soft starter to check if there is a firmware available.

Follow this Access path: **[Device Management] → [Firmware update]**

HMI label	Setting	Factory setting
[Check For Update] <small>NEW</small> 	—	—
This parameter is used to know if a new firmware version is available for the device or the plugged fieldbus modules. NOTE: The update can take up to 10 minutes.		

Proceed a firmware update



The firmware is done in 3 steps:

Step	Actions
1	<p>Transfer: a firmware is transferred from the PC to the soft starter using the selected fieldbus.</p> <p>During this phase the soft starter remains operational.</p>
2	<p>Once the transfer is completed, the firmware package is accessible from [Available Packages] parameter.</p> <p>Follow this Access path: [Device Management] → [Firmware update]</p> <p>This parameter is used to know all available firmware versions, new or legacy, for the device or the plugged fieldbus modules. It includes legacy, current and new firmware versions.</p> <p>NOTE: The update can take up to 20 minutes.</p> <p>NOTE: If the firmware update is not successful, do a power cycle before retrying the action.</p>
3	<p>Select one of available packages and apply it.</p> <div style="border: 1px solid black; padding: 10px; margin: 10px 0;"> <p style="text-align: center;">⚠ WARNING</p> <p>UNANTICIPATED EQUIPMENT OPERATION</p> <p>Verify that the device is stopped (RDY or NST state). The device will not be operational until the firmware update procedure is completed.</p> <p>The relays, the analog and digital outputs may change state during the firmware update process. Depending on the wiring and the configuration of the device, this may result in immediate and unanticipated operation.</p> <p>Before applying the data previously transferred to the device or its option module:</p> <ul style="list-style-type: none"> • Verify that the automation application controlling the device is stopped and that the device and its inputs and outputs, including communication channel(s) to external controller(s), cannot interact with your industrial process, and does not result in unsafe conditions. • Verify that the parameter [Disable Error Detect] INH is not assigned. <p>In case of doubt, disconnect all analog and digital inputs and outputs of the device before applying the firmware update.</p> <p>Failure to follow these instructions can result in death, serious injury, or equipment damage.</p> </div> <p>During this phase, the soft starter is in a [Firmware Update] state. No operations are permitted.</p> <p>Depending on the software used, Transfer and Application can be:</p> <ul style="list-style-type: none"> • Manual: the user confirms a transfer and confirms an application in front of the device using the display terminal or SoMove. • Automatic: the user confirms a transfer and apply, which means once the firmware is transferred, it is automatically applied to the soft starter

Soft starter Firmware information

The soft starter registers firmware information about the soft starter itself, the display terminal and the fieldbus option board.

Information is displayed here:

HMI label	Setting	Factory setting
[Version Info]  VIF	–	–
Follow this Access path: [Device Management] → [Firmware update] This parameter gives the version of the packages applied at the latest firmware update.		
[Identification]  OID	–	–
Follow this Access path: [Device Management] → [Identification] This parameter displays the identification numbers of the soft starter. This is a read-only menu that cannot be configured. It displays the following information: <ul style="list-style-type: none"> • Device name, if defined • Device reference • Current rating • Voltage rating • Device version • Firmware security state • Control version • Power version • Safety version • Ethernet version • Device serial number • Fieldbus module identification if plugged, with name, reference, version and serial number • Display terminal identification, with name, version and serial number 		

Option Modules Firmware update

Updating PROFINET option fieldbus firmware



The PROFINET Fieldbus Module (VW3A3647) can be updated via SoMove, refer to Related Documents.

Updating PROFIBUS option fieldbus firmware

To update the VW3A3607 PROFIBUS fieldbus module, contact our Customer Care Center on: www.se.com/CCC.

Updating CANopen option fieldbus firmware

No update is required with the CANopen option fieldbus.

Graphic Display Terminal Languages Update



The Graphic Display Terminal (VW3A1111) language files can be updated.

Download the latest version of language files here: [Languages_Drives_VW3A1111](#)

The following table describes the procedure to update the language files of the Graphic Display Terminal:

Action	Step
1	Download the latest version of language files here: Languages_Drives_VW3A1111
2	Save the downloaded file on your computer.
3	Unzip the file and follow the instructions of the ReadMe text file.

Cybersecurity operating

What's in This Part

Overview	224
Login	225
Logout	226
Account Management	227
Password	229
PIN Code	231
Admin Credentials Recovery	232
Upgrades Management	233
Save & Restore a Security Policy	234
Port Hardening	235
Security Functionality Verification	236
Clear Device / Secure Decommissioning	239

Overview

All the features listed in this chapter can be configured by using the ATS490 DTM. Refer to *ATS490 DTM Online Help on SoMove* for more information about the detailed settings available.

Login

The user access control can be configured by using the ATS490 DTM Admin tab on SoMove according to table below.

When enabled, the username and associated authentication factor will be requested.

Access	Authentication factor	Settings	Default setting
Graphic display terminal	User Pin code	ON/OFF	OFF
Commissioning tools	User password	ON/OFF — Modbus Serial and Embedded Ethernet	ON
Webserver	User password	ON/OFF	ON

Brute Force Mitigation

Secure account policy defines the maximum wrong password attempts before locking the account during login on the different accesses. The secure account lockout settings are defined in table below and configurable with the ATS490 DTM Admin tab on SoMove. The secure account lockout settings can be set individually on each individual access from Commissioning tools

Parameter	Settings	Settings
Max login attempts	Disable or 1...99 wrong attempts	5
Lock duration	1...86400 seconds (24h)	240s
Password attempt timer (Time between 2 wrong attempts)	60...1800s (30min)	180s

NOTE: To unlock a temporarily locked user due to too many wrong attempts, either:

- Wait until the end of the lock duration time (240s as factory setting), or
- Restart the product, or
- An ADMIN or SecADMIN, manual locks and then manual unlocks the user.

Security Banners

The security banners are warning messages displayed on login interface for system use notification.

The displayed message can be customized by authorized people in the DTM Admin options screen in the limit of 800 characters.

Logout

Manual Logout

For security reasons, it is recommended to logout after any operation on the ATS490 .

- On the graphic display terminal, by pressing **ESC** and **HOME** Keys.
- On the ATS490 DTM on SoMove by disconnecting.
- On the Webserver by logging out.

Auto logout

Auto logout defines the maximum time the user is connected without activity before his session is automatically closed. The auto logout settings are defined in table below and configurable with the ATS490 DTM Admin tab on SoMove.

Parameter	Settings	Default setting
Timeout session	Disabled or 60...5940s	900s

The timeout is applied on the Graphic Display Terminal, commissioning tools and the webserver connections. A setting defined for each channel.

The timeout is not applied when the DTM control panel is enabled

Account Management

Administration Functions

The following administration functions are available for ADMIN and SecAdmin users in the ATS490 DTM Admin tab on SoMove:

- Create/Delete users
 - NOTE:** It is recommended to restart the product after deleting a user.
- Lock/Unlock users
 - NOTE:** Locked users can be Unlocked at any time. The assigned password, pin code and role are retained.
- Configure users
- Assign a role to users
- Assign/Reset/Request Change password and pincode
- Configure the password policy
- Configure session timeout on inactivity
 - NOTE:** The ATS490 is limited to 10 users per device.

When a user is created, a login policy is applied. This policy is not customizable. Here are the rules:

- All printable characters are allowed, except the following: “ [] ; | = + * ? < > / \ ,
- The period character “.” is allowed, but can’t be the final character
- Non-printable characters are not allowed. This includes all characters with ASCII code less than 32 in decimal. The delete control character, with ASCII code 127 in decimal is not allowed too.
- Identifier is not case sensitive. Username is stored in Upper case in the data base.
- Username size is between 4 and 32 characters.
- A username shall not have “NONE”, “ADMIN”, “ROOT”, nor “VIEWER”.
- The username must be unique and not related to your personal information.

Roles and Rights

The ATS490 operations are protected by Role-Based Access Control (RBAC) concept. The roles are assigned with pre-defined rights. The users accounts are then created upon those roles with granted rights which are associated with the corresponding roles.

The following table provides an overview of the roles and their associated rights. The rights of the role cannot be changed from default.

Roles	Default account name (Non-case sensitive)	Rights
Engineer	Defined at user creation	Engineer can perform control actions, update device firmware, change settings, retrieve fault records and upload download the device configuration.
SecAdmin	Defined at user creation	In addition of Engineer rights, SecAdmin can change setting rules and backup retrieve the security configuration & device image.
Admin	ADMIN	In addition of SecAdmin rights, can perform a secure decommissioning of the device.

NOTE: ADMIN user is the system root user.

Roles vs access rights

Rights	ADMIN	SecAdmin	Engineer
Configuration change	✓	✓	✓
Configuration read	✓	✓	✓
Configuration of factory settings	✓	✓	✓
Control	✓	✓	✓
Upload/Download device configuration	✓	✓	✓
Device monitoring	✓	✓	✓
Read security logs	✓	✓	
Read application logs	✓	✓	
Read error/warning logs	✓	✓	
Read device security settings	✓	✓	
Write device security settings	✓	✓	
Port hardening	✓	✓	
Create/Delete/Update/Lock users	✓	✓	
Export/Import security settings	✓	✓	
Backup/Restore device backup image	✓	✓	
Firmware update	✓	✓	✓
Firmware verify	✓	✓	✓
Secure decommissioning	✓		
ADMIN password reset	✓		

Password

Change Password

The individual user password can be changed from the DTM. See the ATS490 DTM Online Help on SoMove for more details.

Reset Password

The Altivar Soft Starter ATS490 stores password in a secure non-reversible format. It is impossible to retrieve a password that has been lost by his user.

For ADMIN user, a special operation is available with the display terminal to reset the ADMIN password to a default value unique to the device.

To reset the ADMIN password:

Step	Action
1	Navigate to the menu [Device Management] → [Cybersecurity]
2	Scroll to the parameter [Reset Password] and press OK
3	The default password is visible on the display terminal in [Default Password] for the duration of 1min.

Upon first use, the commissioning tools will request the user to change this password prior to connecting. The cybersecurity policy does not change when the password is reset.

Other users shall rely on the ADMIN or SecAdmin users to request a reset of their individual password via the ATS490 DTM Admin options screen on SoMove.

Password Policy

By default, the password policy of the Altivar Soft Starter ATS490 complies with IEEE 1686–2013 as following:

- 8 characters minimum with ASCII [32 to 122] characters
- At least one digit (0-9)
- At least one special character (@ % + ' ! # " \$ ^ ? : , () [] ~ _ . ; = & / \ - [SPACE])

In addition, for password changes, the password history is saved and prevents the reuse of a password that has been set at least once in the last 5 times by default.

The password policy can be customized or totally disabled to match with password policy defined in the system of which the device is part.

The following settings are available:

- Password policy: enabled/disabled. If disabled, a password is requested as authentication factor but there is no specific rule defined regarding the password robustness
- Password history: No restriction, Exclude last 3, Exclude last 5
- Special character required: YES/NO
- Numeric character required: YES/NO
- Alphabetic character required: YES/NO
- Minimum password length: any value between 6 and 20

This password policy customizing can only be done with the ATS490 DTM on SoMove or EcoStruxure Control Expert. Please refer to [ATS490 DTM Online Help](#) on SoMove for more details.

PIN Code

PIN Code Access Activation

By default, the PIN code protection of the local Graphic terminal is not enabled. ADMIN or SecADMIN users can decide to activate this security feature with the ATS490 DTM Admin options screen on SoMove.

Once enabled, a login and PIN code will be requested to any user operating with the graphic display terminal. The pin code shall be set up with the ATS490 DTM Admin options screen on SoMove for each individual user. Users with no PIN code preset will not be able to operate with the Graphic display terminal

Change PIN Code

The user PIN code can be changed from the ATS490 DTM Admin options screen on SoMove. Refer to [ATS490 DTM Online Help](#) for more details.

Reset PIN Code

The Altivar Soft Starter ATS490 stores the PIN code in a secure non-reversible format. It is impossible to retrieve a PIN code that has been lost by its user.

Users can request on the ADMIN or SecADMIN users to change their individual PIN code via the ATS490 DTM Admin options screen on SoMove. See [ATS490 DTM Online Help](#) for more details.

Admin Credentials Recovery

In the situation, where the ADMIN user loses both the password and the PIN code, a special operation needs to be executed. The execution of this operation is limited to the ADMIN user only.

Please contact our Customer Care Center on: www.se.com/CCC

Upgrades Management

When the Altivar Soft Starter ATS490 firmware is upgraded, security configuration remains the same until changed, including usernames and passwords. Refer to [Soft starter firmware update, page 219](#) for more information.

It is recommended that security configuration is reviewed after an upgrade to analyze rights for new or changed device features and revoke or apply them according to your company's policies and standards.

Save & Restore a Security Policy

The device cybersecurity policy can be saved on Graphic Display Terminal (depending on the Graphic Display Terminal version). The user has to ensure that the soft starter “source” and soft starter “destination” shall have the same topology (same option card if used, and same firmware).

This menu provides the parameters to backup and restore the cybersecurity policy.

Access path: **[Device Management] → [Cybersecurity]**

HMI label	Setting	Factory setting
[Save security policy] SSE	–	–
This parameter can be used to save the actual cybersecurity policy into the Graphic Display Terminal. The file's name is configurable.		
[Load security policy] OSE	–	–
This parameter can be used to select a cybersecurity policy configuration previously stored in the Graphic Display Terminal and apply it to the soft starter.		

Managing a security policy can also be done by connecting the soft starter to the ATS490 DTM on SoMove and by saving/loading a *.secp file on your PC.

Please refer to the ATS490 DTM Online Help for more information.

Port Hardening

It is possible to disable a communication port or a specific protocol from ATS490 DTM Admin tab on SoMove with the ADMIN or SecADMIN rights.

The table below gives an overview of the physical ports that can be disabled :

Interface / Port	Settings	Default
Modbus Serial Ports		
RJ45/HMI	ON / OFF ⁽¹⁾	ON
RJ45/Network	ON / OFF ⁽¹⁾	ON
Ethernet Interfaces		
ETH0 (Embedded)	ON / OFF	ON
Communication Option Modules		
Profibus	ON / OFF	ON
CANopen	ON / OFF	ON

⁽¹⁾ Either RJ45/HMI port or RJ45/Network port is always available to keep local access for Graphic Display Terminal, commissioning access or ports and service configuration.

NOTE: A change in configuration of the ports above is considered after a power cycle.

Ethernet Services

Ethernet Services	Settings
Modbus TCP	ON / OFF
EtherNet/IP	ON / OFF
DPWS Discovery	ON / OFF
Webserver	ON / OFF
Webserver Password	ON / OFF
SNTP	ON / OFF
IPv4 ICMP	ON / OFF
IPv4 Fixed IP address	ON / OFF
IPv4 DHCP	ON / OFF
IPv4 BootP	ON / OFF
IPv4 SNMP	ON / OFF
IPv6	ON / OFF

Security Functionality Verification

When the cybersecurity policy and functionalities have been configured, it is strongly recommended to verify that the following functions are working as intended.

Human User Access Control

The user access control can be individually tested on each interface of the ATS490 . Please reproduce the following steps for each individual ATS490 interface:

Interface	Step	Action	✓
<ul style="list-style-type: none"> Commissioning tools connected on the Ethernet board Commissioning tools connected on the Modbus Serial interface ATS490 embedded Webserver 	1	Try to connect to the selected interface	
	2	Confirm the security banner is displayed prior authentication is requested	
		Confirm security banner message is in conformity with the message to be displayed for your organization.	
	3	Try to log in to ATS490 with no password or wrong password. Result: ATS490 does not give you access	
	4	Try to login with more than the MaxLoginAttempts (Default value : 5) with wrong password Result: The account is locked during Lock Duration (Default value 240s)	
Confirm the account is locked as well on other interfaces (SoMove (DTM) or Webserver)			
5	During this Lock Duration, connect another account with the right password. Result: SoMove (DTM)/Webserver gives you access.		
Graphic Display Terminal access control (if enabled)	1	Try to log in to the Graphic Display Terminal with no PIN code or a wrong PIN code Result: Graphic Display Terminal does not give you access	
	2	Try to log in with more than the MaxLoginAttempts (Default value : 5) with wrong PIN code Result: The account is locked during Lock Duration (Default value : 240s)	
	3	During this Lock Duration, connect another account with the right password. Result: The Graphic Display Terminal gives you access.	

Confirm that access control is in conformity with the access control configuration requested for your installation.

Password & PIN code Policy

Step	Action	✓
1	Connect to SoMove with your own account	
2	Try to modify your own password	
	Confirm that the password policy displayed is in conformity with the password policy expected for your installation.	
	Change your password, confirm that the selected password is accepted only if it's compliant with the password policy.	
3	Try to modify your own PIN code.	
	Confirm that the PIN code policy displayed is in conformity with the PIN code policy expected for your installation.	
	Change your PIN code, confirm that the selected PIN code is accepted only if compliant with the PIN code policy.	

Timeout Session

Step	Action	✓
1	Connect to DTM, Webserver or Graphic Display Terminal with right credentials	
2	Do nothing during the time defined in timeout tab for the specific channel. Result: The session is automatically disconnected	

Audit

Step	Action	✓
1	After some or all the preceding tests, access the logging page of SoMove (ADMIN or SecADMIN account is requested)	
2	Download the log file	
3	Check that the user activity is correctly monitored in the system log files	

Firmware Update

Step	Action	✓
1	Connect to SoMove	
2	Verify the version of each individual firmware version of the ATS490	
3	Confirm that the versions are as expected	
4	Try to perform a firmware update	
5	Select a random file	

Disabling Communication Ports

Step	Action	✓
1	For each individual port disabled by configuration	
2	Confirm the ports are no longer usable	
	No data flow detected as output and no data accepted as input	
4	For each individual port disabled by configuration, confirm the protocol refuses communication according to the column verification of chapter Port Hardening, page 235	

Ethernet Services

Available only with Ethernet option board. Refer to fieldbus manual for additional information.

Ethernet Services	Action	✓
ICMP IPv4	ON: Ping responds	
	OFF: Ping timeout	
Webserver	ON: Webserver displayed	

Ethernet Services	Action	✓
	OFF: Webserver doesn't respond and "Enable password" field locked	
Enable Webserver Password	ON : Login is required to connect to webserver	
	OFF : No login is required to connect to webserver	
SNMP IPv4	ON: snmpB (open source software) responds and display the MIB tree	
	OFF:snmpB doesn't respond (timeout) — UDP Port 162 is no more reachable.	
DPWS Discovery	ON: Open network window on Microsoft Windows. Refresh it and see the Schneider's equipment	
	OFF: Open network window on Microsoft Windows. Refresh it and verify that the equipment doesn't appear	
IPv4 DHCP	ON: DHCP client enables – Retrieve an IPV4 address	
	OFF: The device doesn't communicate any traffic to a DHCP server	
SNTP	ON: device clock is updated	
	OFF: device clock is not synchronized with the server. Device doesn't communicate any traffic through SNTP protocol	
Modbus TCP	ON: Open DTM (SoMove) with TCP connection. DTM connects to the product	
	OFF: Open DTM (SoMove) with TCP connection. DTM can't connect to the product	
Ethernet/IP	ON: Identity class replies revision firmware of the product	
	OFF: Identity class display an error - The ports TCP 44818 and UDP 44818 are no longer reachable	
IPv4 fixed IP adress	ON: IPV4 fixed address is authorized	
	OFF: IPV4 doesn't support fixed address – Alarm appears	
IPv4 BootP	ON: IPV4 BootP address is authorized	
	OFF: The device doesn't communicate any traffic to BootP server	
IPv6	ON: ping IPV6 communication authorized	
	OFF: IPV6 address unauthorized. Ping ipv6 not respond	

Clear Device / Secure Decommissioning

The device security policy can be totally erased. This operation is part of the device secure disposal use case executed during clear device operation. This operation can be done by ADMIN user only.

Upon execution, security settings are totally erased from the device, including any internal backup, usernames, passwords, Ports and services, Brute force mitigation, Session timeout.

For security reasons, it is strongly recommended to perform this operation while removing the device from its intended environment.

To erase the device security policy go to one of those menu on the graphical display terminal:

- **[Device Management] → scroll to [Clear device]**
- **[Device Management] → [Save/Load] and scroll to [Clear device]**

This parameter is visible in expert mode only. To active the expert mode go to the menu **[My preferences] → [Parameter access]** and set **[Access Level]** to **[Expert]**.

NOTE: When the Security Policy is set to Advanced, only an Admin user can perform a secure decommissioning.

Communication

What's in This Part

Modbus VP12S port configuration	241
Modbus Network Diagnostics	244
Ethernet Embedded Configuration	245
Ethernet Embedded Diagnostic	247
PROFINET module Basic Settings	248
CANopen fieldbus	252
PROFIBUS fieldbus.....	254

Introduction

The soft starter integrates capabilities to be connected to an industrial fieldbus.

The soft starter embeds:

- 1 Modbus HMI port, used to plug graphic display terminals.
- 1 Modbus VP12S port
- 1 Ethernet port
- 1 slot for connecting fieldbus option cards, to enable CANopen and PROFIBUS.

The chapter proposes to configure the device to prepare operation through fieldbus. For more information refer to the dedicated fieldbus manual in [Related Documents](#), page 14.

Modbus VP12S port configuration

Access path: **[Communication]→[Modbus Fieldbus]**

The Modbus VP12S port can be used to configure the soft starter with SoMove DTM through Modbus RTU or to communicate a PLC.





The Modbus VP12S port can also be used to control the soft starter through Modbus RTU fieldbus. Please adjust Address, Baudrate, Format, Parity and Time out parameters. For controlling the soft starter via Modbus, refer to the Embedded Modbus RTU Manual for more information.

Connection with a display terminal

To connect a display terminal to the Modbus RTU port, this configuration must be set:

- **[Modbus Baud Rate]** must be set to **[19200 bps]**.
- **[Term word order]** must be set to **[ON]**.
- **[Modbus Format]** must be set to **[8-E-1]**.

Modbus VP12S menu configuration

HMI label	Setting	
[Modbus Address] <small>ADD</small> 	Logic address: 1771 hex = 6001 Range: 0...247 Factory setting: 0 (OFF)	Type: UINT (Unsigned16) Read/write: R/WS
<p>Device modbus address</p> <p>This parameter sets the embedded Modbus soft starter address. Address 0 is reserved for broadcast.</p>		
[Modbus Baud Rate] <small>TBR</small> 	Logic address: 1773 hex = 6003 Factory setting: [19200 bps]	Type: WORD (Enumeration) Read/write: R/WS Unit: bps
<p>Modbus baud rate</p> <p>This parameter sets the embedded Modbus baud rate.</p> <ul style="list-style-type: none"> • [4800 bps] : 4,800 bauds • [9600 bps] : 9,600 bauds • [19200 bps] : 19,200 bauds • [38.4 Kbps] : 38,400 bauds 		
[Term word order] <small>TWO</small> 	Logic address: 1776 hex = 6006 Factory setting: [ON]	Type: WORD (Enumeration) Read/write: R/WS
<p>Terminal Modbus: Word order</p> <p>This parameter sets the embedded Modbus terminal word order.</p> <ul style="list-style-type: none"> • [OFF] : Low word first • [ON] : High word first 		
[Modbus Format] <small>TFO</small> 	Logic address: 1774 hex = 6004 Factory setting: [8-E-1]	Type: WORD (Enumeration) Read/write: R/WS
<p>Modbus format</p> <p>This parameter sets the embedded Modbus frame format.</p> <p>NOTE: Connection to SoMove is done using the format [8-E-1] .</p> <ul style="list-style-type: none"> • [8-O-1] : 8 bits odd parity 1 stop bit • [8-E-1] : 8 bits even parity 1 stop bit • [8-N-1] : 8 bits no parity 1 stop bit • [8-N-2] : 8 bits no parity 2 stop bits 		

HMI label	Setting	
[ModbusTimeout] TTO	Logic address: 1775 hex = 6005 Range: 0.1...30 s Factory setting: 5 s	Type: UINT (Unsigned16) Read/write: R/WS Unit: 0.1 s
<p>Modbus timeout</p> <p>This parameter sets the embedded Modbus communication timeout.</p> <p>NOTE: For information, the communication timeout with the display terminal is 2 seconds and cannot be modified.</p>		
[Modbus Error Resp] SLL	Logic address: 1B62 hex = 7010 Factory setting: [Freewheel Stop]	Type: WORD (Enumeration) Read/write: R/WS
<p>Response to Modbus interruption</p> <p>This parameter sets the type of stop applied to the motor when a loss of communication is detected on the Modbus channel for both ports.</p> <ul style="list-style-type: none"> • [Ignore]: Trigger [Modbus Com Warn] SLLA. The warning should be assigned to a warning group in [Warn groups config] to be visible when triggered. Refer to <i>Warning Messages</i>, page 289. • [Freewheel Stop]: Error [Mdb Com Interrupt] SLF1 is triggered and motor stops in freewheel. • [Configured Stop]: Motor stops according to the value set in [Type of stop], [Modbus Com Warn] SLLA is triggered. • [Deceleration]: Motor stops in deceleration and an error [Mdb Com Interrupt] SLF1 is triggered at the end of deceleration. • [Braking]: Motor stops in dynamic braking stop and an error [Mdb Com Interrupt] SLF1 is triggered at the end of stop. 		
<p>⚠ WARNING</p> <p>LOSS OF CONTROL</p> <p>If this parameter is set to [Ignore], Modbus communication monitoring is disabled.</p> <ul style="list-style-type: none"> • Only use this setting after a thorough risk assessment in compliance with all regulations and standards that apply to the device and to the application. • Only use this setting for tests during commissioning. • Verify that communication monitoring has been re-enabled before completing the commissioning procedure and performing the final commissioning test. <p>Failure to follow these instructions can result in death, serious injury, or equipment damage.</p>		
[Product restart] RP	-	[Not Assigned] NO
<p>Product restart</p> <p>For more information, refer to <i>Product Restart</i>, page 218.</p>		

Modbus Network Diagnostics

Used for the Modbus serial communication port at the bottom of the control block.

Access path: **[Communication]**

[Modbus network diag] menu

HMI label	Setting	Factory setting
[COM LED] <small>MDB1</small>	–	–
COM LED View of the Modbus communication LED.		
[Mdb Frame Nb] <small>M1CT</small>	Logic address: 177B hex = 6011 Range: 0...65535	Type: UINT (Unsigned16) Read/write: R Unit: -
Mdb frame number Indicate the number of Modbus frames send or received. The counter counts both correct and incorrect frames. Mdb frame number is modulo 65 536 counters, this means that, the value is reset to zero once the value of 65 535 is reached.		
[Mdb CRC errors] <small>M1EC</small>	Logic address: 177A hex = 6010 Range: 0...65535	Type: UINT (Unsigned16) Read/write: R
Mdb CRC errors Indicate the number of Modbus frames containing checksum errors. By contrast of [Mdb Frame Nb] , the [Mdb CRC errors] remain at 65 535 once this value is reached.		
[Mdb com stat] <small>COM1</small>	Logic address: FA2F hex= 64047	Type: WORD (Enumeration) Read/write: R
Modbus com. status Modbus communication status. <ul style="list-style-type: none"> • [R0T0] : Modbus no reception, no transmission • [R0T1] : Modbus no reception, transmission • [R1T0] : Modbus reception, no transmission • [R1T1] : Modbus reception and transmission 		

In the case of these two counters (**[Mdb CRC errors]** and **[Mdb Frame Nb]**), only frames that are destined for the device and whose Modbus address is supplied by the **[Modbus Address]** parameter are counted. Broadcast frames are not counted.





Ethernet Embedded Configuration

This menu is to configure the parameters used by the Ethernet Embedded port.

For controlling the soft starter via Embedded Ethernet, refer to Ethernet Manual for more information.

Access path: **[Communication]**.

[Embd Eth Config] menu





HMI label	Setting	
[Device Name] PAN	–	
<p>This parameter is used to set the device name.</p> <p>The FDR (Fast Device Replacement) service is based on identification of the device by a Device Name. In the case of the Altivar soft starter, this is represented by the [Device Name] PAN parameter. Verify that all the network devices have different Device Name.</p>		
[IP Mode Ether. Embd] IM00 	Logic address: FB90 hex = 64400	Type: WORD (Enumeration) Read/write: R/W
<p>IP mode Ethernet Embd</p> <p>This parameter is used to select the IP address assignment method:</p> <ul style="list-style-type: none"> • [Fixed] MANU: Manually set the IP address. • [BOOTP] BOOTP: Automatically gets the IP address from the Bootp or DHCP server using the MAC address. • [DHCP] DHCP: Automatically gets the IP address from the DHCP server using the device name (factory setting). 		
[IP address] IC01, IC02, IC03, IC04 	Logic address IC01: FB91 hex = 64401 Logic address IC02: FB92 hex = 64402 Logic address IC03: FB93 hex = 64403 Logic address IC04: FB94 hex = 64404	Type: INT Read/write: R/W
<p>This parameter is used to set the IP address and can be edited only when the IP mode is set to fixed address.</p>		
[Mask] IM01, IM02, IM03, IM04 	Logic address IM01: FB95 hex = 64405 Logic address IM02: FB96 hex = 64406 Logic address IM03: FB97 hex = 64407 Logic address IM04: FB98 hex = 64408	Type: INT Read/write: R/W
<p>This parameter is used to set the IP subnet mask and can be edited only when IP mode is set to fixed address.</p>		
[Gateway] IG01, IG02, IG03, IG04 	Logic address IG01: FB99 hex = 64409 Logic address IG02: FB9A hex = 64410 Logic address IG03: FB9B hex = 64411 Logic address IG04: FB9C hex = 64412	Type: INT Read/write: R/W
<p>This parameter is used to set the default gateway address and can be edited only IP mode is set to fixed address.</p>		

HMI label	Setting	
[Eth embd : Time-out] TTOB	Logic address: FB9F hex = 64415 Range: 0.1...30.0 s Factory setting: 10.0 s	Type: UINT (Unsigned16) Read/write: R/WS Unit: 0.1 s
Ethernet embedded : time-out		
[Eth Error Response] ETHL	Logic address: 1B6D hex = 7021 CIP Path: 84/01/16 hex = 132/01/22	Type: WORD (Enumeration) Read/write: R/WS Factory setting: [Freewheel Stop]
<p>Ethernet error response This parameter defines the Ethernet embedded error stop mode.</p> <ul style="list-style-type: none"> • [Ignore]: No error or warning is triggered. • [Freewheel Stop]: Error [Embd Eth Com Interrupt] ETHF is triggered and motor stops in freewheel. • [Configured Stop]: Motor stops according to the value set in [Type of stop]. • [Deceleration]: Motor stops in deceleration and an error [Embd Eth Com Interrupt] ETHF is triggered at the end of deceleration. • [Braking]: Motor stops in dynamic braking stop and an error [Embd Eth Com Interrupt] ETHF is triggered at the end of stop. 		
⚠ WARNING		
<p>LOSS OF CONTROL</p> <p>If this parameter is set to [Ignore] NO, Ethernet communication monitoring is disabled.</p> <ul style="list-style-type: none"> • Only use this setting after a thorough risk assessment in compliance with all regulations and standards that apply to the device and to the application. • Only use this setting for tests during commissioning. • Verify that communication monitoring has been re-enabled before completing the commissioning procedure and performing the final commissioning test. <p>Failure to follow these instructions can result in death, serious injury, or equipment damage.</p>		
[Modbus Address] ADD 	Logic address: 1771 hex = 6001 CIP Path: 7F/01/02 hex = 127/01/02 Range: 0...247 Factory setting: 0	Type: UINT (Unsigned16) Read/write: R/WS Unit: -
<p>Device modbus address</p> <p>This parameter sets the Modbus device address. Address 0 is reserved for broadcast.</p>		
[Product restart] RP	–	[Not Assigned] NO
<p>Product restart</p> <p>For more information, refer to Product Restart, page 218.</p>		

Ethernet Embedded Diagnostic

Access path: **[Communication]**

[Ethernet Emb Diag] menu

HMI label	Setting	
[MAC @] 	—	
This parameter displays the MAC address of the Ethernet Embedded port in the format [MM-MM-MM-XX-XX-XX] .		
[ETH emb Rx frames] <small>ERXE</small> 	Logic address: FBA0 hex = 64416	Type: UINT (Unsigned32) Read/write: R
Ethernet embedded Rx frames This parameter displays the Ethernet module received Rx frames counter.		
[ETH emb Tx frames] <small>ETXE</small> 	Logic address: FBA2 hex = 64418	Type: UINT (Unsigned32) Read/write: R
Ethernet embedded Tx frames This parameter displays the Ethernet module transmitted frames counter.		
[ETH emb error frames] <small>EERE</small> 	Logic address: FBA4 hex = 64420	Type: UINT (Unsigned32) Read/write: R
Ethernet embedded error frames This parameter displays the Ethernet module error frames counter.		
[Ethernet Rate Data] <small>ARDE</small> 	Logic address: FB9D hex = 64413	Type: WORD (Enumeration) Read/write: R
Ethernet rate data This parameter displays the Ethernet module actual rate. <ul style="list-style-type: none"> • [Auto]: Data rate is auto detected depending on the first data packet received. • [10M. full]: Data rate is set to 10 Mbit/s full. • [10M. half]: Data rate is set to 10 Mbit/s half. • [100M. full]: Data rate is set to 100 Mbit/s full. • [100M. half]: Data rate is set to 100 Mbit/s half. 		

PROFINET module Basic Settings

Introduction

The parameters are described according to the Graphic Display Terminal.

These settings are also possible from commissioning software.

For controlling the soft starter via Profinet, refer to PROFINET Manual for more information.

Access

The parameters are accessible in the **[Communication]** → **[Profinet]**.

Possible Settings

The table presents the parameter settings:

HMI label	Setting	
[IP mode] <i>IPM</i>	Logic address: FBC2 hex = 64250 Factory setting: [DCP] <i>DCP</i>	Type: WORD (Enumeration) Read/write: R/W

IP mode

This parameter is used to select the IP address assignment method:



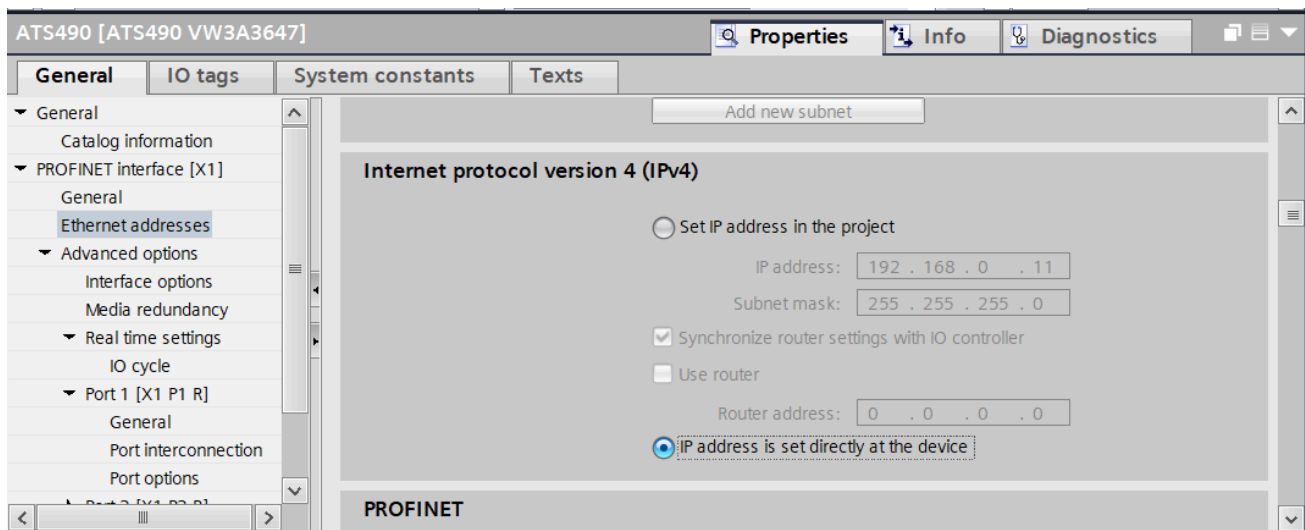

- [Fixed] *MANU*: Manually set the IP address.
- [DHCP] *DHCP*: Automatically gets the IP address from the DHCP server using the device name.
- [DCP] *DCP*: Automatically gets the IP address from the DCP server using the station name.

NOTE: To use [Fixed] *MANU* mode, select "IP address is set directly at the device".

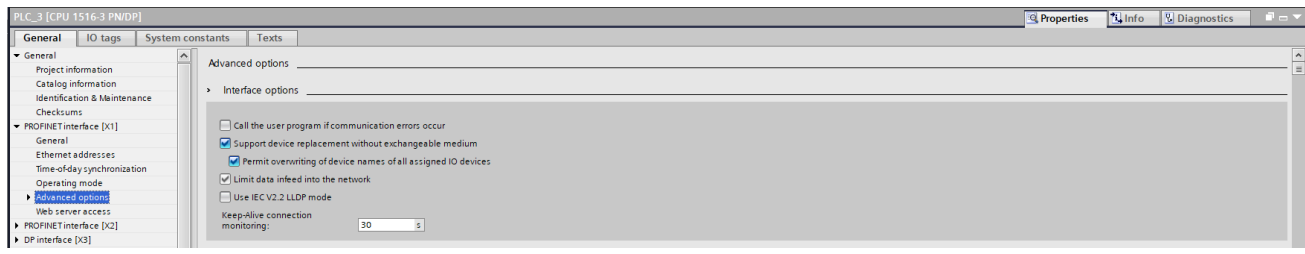

NOTE: The parameter is forced to [DCP] *DCP* if "Support device replacement without exchangeable medium" is selected (only available with a Siemens PLC).



HMI label	Setting	
[IP Module] IPC1, IPC2, IPC3, IPC4 [IP mode] IPM → [Fixed] MANU → 	Logic address IPC1: FAD4 hex = 64212 Logic address IPC2: FAD5 hex = 64213 Logic address IPC3: FAD6 hex = 64214 Logic address IPC4: FAD7 hex = 64215	Type: UINT (Unsigned16) Read/write: R/W
Configured Profinet IP Address This parameter is used to set the IP address and can be edited only when the IP mode is set to fixed address. The modification of this parameter setting is only effective when you restart the soft starter if [IP mode] IPM is set to [Fixed] MANU.		
[IP Mask] IPM1, IPM2, IPM3, IPM4 [IP mode] IPM → [Fixed] MANU → 	Logic address IPM1: FAD8 hex = 64216 Logic address IPM2: FAD9 hex = 64217 Logic address IPM3: FADA hex = 64218 Logic address IPM4: FADB hex = 64219	Type: UINT (Unsigned16) Read/write: R/W
Configured Profinet IP mask This parameter can be edited only when the IP mode is set to fixed address. The modification of this parameter setting is only effective when you restart the soft starter if [IP mode] IPM is set to [Fixed] MANU.		
[IP Gate] IPG1, IPG2, IPG3, IPG4 [IP mode] IPM → [Fixed] MANU → 	Logic address IPG1: FADC hex = 64220 Logic address IPG2: FADD hex = 64221 Logic address IPG3: FADE hex = 64222 Logic address IPG4: FADF hex = 64223	Type: UINT (Unsigned16) Read/write: R/W
Configured Profinet IP Gate This parameter can be edited only when the IP mode is set to fixed address. The modification of this parameter setting is only effective when you restart the soft starter if [IP mode] IPM is set to [Fixed] MANU.		
[Actual IP] IPA1, IPA2, IPA3, IPA4 [IP mode] IPM → [Fixed] MANU → 	Logic address IPA1: FAFC hex = 64252 Logic address IPA2: FAFD hex = 64253 Logic address IPA3: FAFE hex = 64254 Logic address IPA4: FAFF hex = 64255	Type: UINT (Unsigned16) Read/write: R
Actual IP Address This parameter can be accessed only when [IP mode] IPM is set to [DHCP] or to [DCP] . This is the current IP setting taken into account by the soft starter.		
[Actual mask] IPS1, IPS2, IPS3, IPS4 [IP mode] IPM → [Fixed] MANU → 	Logic address IPS1: FB00 hex = 64256 Logic address IPS2: FB01 hex = 64257 Logic address IPS3: FB02 hex = 64258 Logic address IPS4: FB03 hex = 64259	Type: UINT (Unsigned16) Read/write: R
Actual IP Mask This parameter can be accessed only when [IP mode] IPM is set to [DHCP] or to [DCP] .		



HMI label	Setting	
[Actual gate.] IPT1, IPT2, IPT3, IPT4 [IP mode] IPM → [Fixed] MANU → 	Logic address IPT1: FB04 hex = 64260 Logic address IPT2: FB05 hex = 64261 Logic address IPT3: FB06 hex = 64262 Logic address IPT4: FB07 hex = 64263	Type: UINT (Unsigned16) Read/write: R
Actual IP Gate This parameter can be accessed only when [IP mode] IPM is set to [DHCP] or to [DCP] .		
[PPO profile used] PRFL	Logic address: 1A09 hex = 6665	Type: UINT (Unsigned16) Read/write: R
PPO profile used This parameter displays the actual profile for the device. The parameter settings are: <ul style="list-style-type: none"> • [0] = UNCG / not configured • [100] = Telegram 100 • [101] = Telegram 101 • [102] = Telegram 102 • [106] = Telegram 106 • [107] = Telegram 107 		
[MAC @] MAC	Type: UINT (Unsigned16) Read/write: R	
This parameter displays the MAC address of the Profinet VW3A3647 option module.		
[Fdbus Interrupt Resp] CLL	Logic address: 1B67 hex = 7015 Factory setting: [Freewheel Stop]	Type: WORD (Enumeration) Read/write: R/WS
Response to Fieldbus module communication interruption This parameter defines the error stop mode. <ul style="list-style-type: none"> • [Ignore] : Detected error ignored (in this case, the warning [Fieldbus Com Warn] CLLA is activated). • [Freewheel Stop] : Motor triggers in [Fdbus Com Interrupt] CNF error and is stopped in freewheel. • [Configured Stop] : Motor is stopped according to [Type of stop] parameter. • [Deceleration] : Motor is stopped in deceleration and triggers in [Fdbus Com Interrupt] CNF error at the end of stop. • [Braking] : Motor is stopped in dynamic braking and triggers in [Fdbus Com Interrupt] CNF error at the end of stop. 		
⚠ WARNING		
LOSS OF CONTROL		
If this parameter is set to [Ignore] , fieldbus module communication monitoring is disabled.		
<ul style="list-style-type: none"> • Only use this setting after a thorough risk assessment in compliance with all regulations and standards that apply to the device and to the application. • Only use this setting for tests during commissioning. • Verify that communication monitoring has been re-enabled before completing the commissioning procedure and performing the final commissioning test. 		
Failure to follow these instructions can result in death, serious injury, or equipment damage.		

CANopen fieldbus

The menu **[CANopen]** provides the parameters to set the CANopen fieldbus communication. This menu is visible only if the module VW3A3608, VW3A3618 or VW3A3628 is plugged into the soft starter.

Access path: **[Communication]**

[CANopen] menu

HMI label	Setting	
[CANopen Address] <small>ADCO</small> 	Logic address: 17A3 hex = 6051 Range: 0..127	Type: UINT (Unsigned16) Read/write: R/WS Factory setting: [OFF] OFF
<p>This parameter defines the address of the soft starter on the network.</p> <p>This parameter can be set to:</p> <ul style="list-style-type: none"> • [OFF]: CANopen address is not assigned (value: 0). • [1 to 127]: CANopen address is assigned (value : 1...127). 		
[CANopen Baudrate] <small>BDCO</small> 	Logic address: 17A5 hex = 6053	Type: WORD (Enumeration) Read/write: R/WS Unit: bps Factory setting: [250 kbps] 250K
<p>This parameter defines the baud rate at which data is transferred.</p> <p>This parameter can be set to:</p> <ul style="list-style-type: none"> • [50 kbps]: Baud rate is set to 50 Kbps (value: 38). • [125 kbps]: Baud rate is set to 125 Kbps (value: 52). • [250 kbps]: Baud rate is set to 250 Kbps (value: 60). • [500 kbps]: Baud rate is set to 500 Kbps (value: 68). • [1 Mbps]: Baud rate is set to 1 Mbps (value: 76). 		

HMI label	Setting	
[CANopen Error Resp] COL	Logic address: 1B63 hex = 7011	Type: WORD (Enumeration) Read/write: R/WS Factory setting: [Freewheel Stop] YES
<p>This parameter defines the CANopen error stop mode:</p> <ul style="list-style-type: none"> • [Ignore]: Trigger [CANopen Com Warn] COLA (internal bit and configurable digital output). The warning should be assigned to a warning group in [Warn groups config] to be visible when triggered. Refer to Warning Messages, page 289. • [Freewheel Stop]: Error [CANopen Com Interrupt] COF is triggered and motor stops in freewheel. • [Configured Stop]: Motor stops according to the value set in [Type of stop], [CANopen Com Warn] COLA is triggered. • [Deceleration]: Motor stops in deceleration and an error [CANopen Com Interrupt] COF is triggered at the end of deceleration. • [Braking]: Motor stops in dynamic braking stop and an error [CANopen Com Interrupt] COF is triggered at the end of stop. 		
<h2>⚠ WARNING</h2> <p>LOSS OF CONTROL</p> <p>If this parameter is set to [Ignore] NO, CANopen communication monitoring is disabled.</p> <ul style="list-style-type: none"> • Only use this setting after a thorough risk assessment in compliance with all regulations and standards that apply to the device and to the application. • Only use this setting for tests during commissioning. • Verify that communication monitoring has been re-enabled before completing the commissioning procedure and performing the final commissioning test. <p>Failure to follow these instructions can result in death, serious injury, or equipment damage.</p>		
[Product restart] RP	Logic address: 1BD8 hex = 7128	Type: WORD (Enumeration) Read/write: R/WS Factory setting: [No]
<p>Product restart</p> <p>For more information, refer to Product Restart, page 218.</p>		

PROFIBUS fieldbus

The menu **[Profibus]** provides the parameters to set the Profibus fieldbus communication. This menu is visible only if the module VW3A3607 is plugged into the soft starter.

Access path: **[Communication]**

[Profibus] menu

HMI label	Setting	
[Address] <small>ADRC</small> 	Logic address: 19C9 hex = 6601 Range: 2...126 Factory setting: 126	Type: UINT (Unsigned16) Read/write: R/W
Device address		
[Fdbus Interrupt Resp] <small>CLL</small>	Logic address: 1B67 hex = 7015 Factory setting: [Freewheel Stop]	Type: WORD (Enumeration) Read/write: R/W
<p>Response to Fieldbus module communication interruption This parameter defines the PROFIBUS DP error stop mode.</p> <ul style="list-style-type: none"> • [Ignore]: Trigger [Fieldbus Com Warn] <small>CLLA</small> (internal bit and configurable digital output). The warning should be assigned to a warning group in [Warn groups config] to be visible when triggered. Refer to Warning Messages, page 289. • [Freewheel Stop]: Error [Fdbus Com Interrupt] <small>CNF</small> is triggered and motor stops in freewheel. • [Configured Stop]: Motor stops according to the value set in [Type of stop], [Fieldbus Com Warn] <small>CLLA</small> is triggered. • [Deceleration]: Motor stops in deceleration and an error [Fdbus Com Interrupt] <small>CNF</small> is triggered at the end of deceleration. • [Braking]: Motor stops in dynamic braking stop and an error [Fdbus Com Interrupt] <small>CNF</small> is triggered at the end of stop. 		
⚠ WARNING		
<p>LOSS OF CONTROL</p> <p>If this parameter is set to [Ignore], fieldbus module communication monitoring is disabled.</p> <ul style="list-style-type: none"> • Only use this setting after a thorough risk assessment in compliance with all regulations and standards that apply to the device and to the application. • Only use this setting for tests during commissioning. • Verify that communication monitoring has been re-enabled before completing the commissioning procedure and performing the final commissioning test. <p>Failure to follow these instructions can result in death, serious injury, or equipment damage.</p>		
[Product restart] <small>RP</small>	Logic address: 1BD8 hex = 7128	Type: WORD (Enumeration) Read/write: R/W Factory setting: [No]
<p>Product restart</p> <p>For more information, refer to Product Restart, page 218.</p>		

Monitor the displayed values

What's in This Part

Motor Parameters	256
Monitor thermal measurements	262
Counter Management	263
Other States	264
Input & Output Map	265
Energy parameters	267

This menu provides the parameters to monitor the key physical values of the motor, the soft starter and the application such as:

- Motor electrical and torque values
- Device and motor thermal state
- Device and motor run time
- State of the device
- Inputs/Outputs status and assignment

Motor Parameters

What's in This Chapter

Monitor current measurements	257
Monitor voltage measurements	258
Monitor power measurements	259
Monitor other measurements.....	260

Monitor current measurements

This menu provides the parameters to monitor current measurements.

Access path: **[Display]** → **[Motor parameters]** → **[Currents]**

HMI label	Display	Factory setting
[Motor Current] <small>LCR</small>	Unit: Current Unit, page 329.	–
Motor current RMS motor current. Average of the three line currents based on the measurement of the fundamental of the motor line currents.		
[Mains Frequency] <small>FAC</small>	0...100.0Hz	–
Mains frequency Estimated Frequency value of the mains.		
[Current RMS T1] <small>LCR1</small>	Unit: Current Unit, page 329.	–
Current RMS Phase T1		
[Current RMS T2] <small>LCR2</small>	Unit: Current Unit, page 329.	–
Current RMS Phase T2		
[Current RMS T3] <small>LCR3</small>	Unit: Current Unit, page 329.	–
Current RMS Phase T3		
[Current Unbalance] <small>CUR</small>	NA...100%	–
Estimated Unbalance of the currents (% of Current RMS [Motor Current])		

Monitor voltage measurements

This menu provides the parameters to monitor voltage measurements.

Access path: [Display] → [Motor parameters] → [Voltages]

HMI label	Display	Factory setting
[Mains Voltage] <i>ULNM</i>	0...1000V	–
Mains Voltage (RMS) RMS mains voltage. Average of the three line voltage based on the measurement of the fundamental of the mains line voltage.		
[Mains Frequency] <i>FAC</i>	0...100.0Hz	–
Mains frequency Estimated Frequency value of the mains.		
[Mains voltage phase 1-2] <i>UL1</i>	0...1000V	–
Mains voltage phase 1-2		
[Mains voltage phase 2-3] <i>UL2</i>	0...1000V	–
Mains voltage phase 2-3		
[Mains voltage phase 3-1] <i>UL3</i>	0...1000V	–
Mains voltage phase 3-1		
[Mains Unbalance Ratio] <i>UMV</i>	0...100%	–
Mains unbalance ratio [Mains Unbalance Ratio] <i>UMV</i> is defined as the ratio of the negative sequence voltage component to the positive sequence voltage component.		
[Voltage Sag Counter] <i>MVSC</i>		
Voltage Sag Counter A voltage sag is a short-term decrease in voltage levels, typically lasting from a half-cycle to a few seconds. If at least one phase to phase voltage drops 10% of mains reference [Mains Voltage] (start of Voltage Sag Counter): <ul style="list-style-type: none"> The Voltage Sag Counter is incremented. on a ½ cycle and then all phase to phase voltage come back within 10% of mains reference (End of Voltage Sag Counter) within next 6000 ½ cycles (1 minute @50Hz). The Voltage Sag Counter is not incremented. for less than a ½ cycle or all phase to phase voltage come back within 10% of mains reference (End of Voltage Sag Counter) after more than 6000 ½ cycles (1 minute @50Hz). NOTE: a 2% hysteresis around 90% of [Mains Voltage] threshold is used for start and end of Voltage Sag Counter . <ul style="list-style-type: none"> The counter can be reset using [Counter Reset]. For more information refer to Counter Management, page 263. A warning [Voltage Sag Warn] is raised when a Voltage Sag Counter has been detected. The warning should be assigned to a warning group in [Warn groups config] to be visible when triggered. Refer to Warning Messages, page 289. 		

Monitor power measurements

This menu provides the parameters to monitor power measurements.

Access path: **[Display]** → **[Motor parameters]** → **[Powers]**

HMI label	Display	Factory setting
[Power Factor] COS	0.00...1.00	–
Power factor		
[Device Efficiency] DEFF	0...100 %	–
Device efficiency		
This parameter is visible only if the motor nameplate parameters are configured. Refer to Set Motor Nameplate Parameters, page 151.		
[Acv Elc Out Pwr in %] EPR	0...500 %	–
Active Electrical output power in %		
Active electrical output power in % of motor nominal power.		
[Acv Elc Out Pwr in kW] EPRW	Unit: Electrical Power Unit, page 329.	–
Active Electrical output power in kW		
[Peak Elec Out Power] MOEP	Unit: Electrical Power Unit, page 329.	–
Peak electrical output power		
Maximum value of electrical power consumed.		
[Input Reactive Power] IQRW	Setting: –3276.7...3276.7 Unit: Reactive Power Unit, page 329.	–
Input reactive power		

Monitor other measurements

This menu provides the parameters to monitor other measurements.

Access path: **[Display]** → **[Motor parameters]** → **[Others]**

HMI label	Display	Factory setting
[Motor Torque] <i>LTR</i>	0...255 % of the nominal torque	–
Torque reference		
[Est. Motor Torq Val.] <i>LTRN</i>	-32767...32767 N.m Unit: Torque Unit, page 329.	–
Estimated motor torque value		
This parameter is visible only if the motor nameplate parameters are configured. Refer to Set Motor Nameplate Parameters, page 151.		
[Nom Motor torque] <i>TQN</i>	NA...30000 N.m Unit: Torque Unit, page 329.	–
Computed nominal motor torque		
This parameter displays the nominal torque and is visible only if the motor nameplate parameters are configured. Refer to Set Motor Nameplate Parameters, page 151.		
[Mot Mech Power in %] <i>OPR</i>	NA...250%	–
Motor power in %		
This parameter is visible only if the motor nameplate parameters are configured. Refer to Set Motor Nameplate Parameters, page 151.		
[Power Estim Value] <i>OPRW</i>	Setting: NA...32767 Unit: Electrical Power Unit, page 329 and [Motor Power unit] <i>MPUT</i> , page 152	–
Motor mechanical power estimation		
This parameter is visible only if the motor nameplate parameters are configured. Refer to Set Motor Nameplate Parameters, page 151.		
[Time Before Starting] <i>MRTR</i>	0..4294967295 s	–
Maximum remaining time before restart		
For more information, refer to How to interpret and react to a TBS state, page 328.		
[Phase Direction] <i>PHE</i>	–	–
Detected phase direction		
Detect the phase inversion if [Phase Inversion Mon] <i>PHR</i> is configured.		
<ul style="list-style-type: none"> [123]: direct network (L1 - L2 - L3). [321]: indirect network (L1 - L3 - L2). 		
[Real Start Time] <i>RSTT</i>	0...1000s	–
Real Start Time		
[Braking Speed Thld] <i>BRKS</i>	NA...100%	–

HMI label	Display	Factory setting
<i>Braking speed threshold</i> This parameter is available only if [Type of stop] is set to [Braking] . For more information about <i>Type of stop</i> , refer to Set Stop Profile, page 125.		
[Braking Duration] BRKT	0...1000s	–
<i>Braking duration(from brake order to DC injection end)</i> This parameter is available only if [Type of stop] is set to [Braking] . For more information about <i>Type of stop</i> , refer to Set Stop Profile, page 125.		

Monitor thermal measurements

This menu provides the parameters to monitor thermal measurements.

Access path: **[Display]** → **[Thermal Monitoring]**

HMI label	Display	Factory setting
[Motor Therm State] THR	0...300 %	–
<p>Motor thermal state</p> <p>This parameter monitors the motor thermal state. 100% corresponds to the nominal thermal state at the nominal motor current set to [Motor Nom Current]. For more information, refer to <i>Motor Thermal Protection Class</i>, page 129.</p>		
[Time Before Starting] THTR	NA...3600s	–
<p>Motor thermal remaining time before restart</p> <p>NOTE: to see [Time Before Starting] value, [Mot Therm Estimation] must be set to [Yes].</p> <p>NOTE: for more information about the [Wait for Restart] TBS; refer to <i>How to interpret and react to a TBS state</i>, page 328.</p>		
[AI1 Th Value] TH1V	–15...200°C	–
<p>AI1 thermal value</p> <p>NOTE: [AI1 Th Value] is available if the thermal sensor is a KTY, PT100 or a PT1000.</p>		
[Device Thermal State] THS	0...200 %	–
<p>Device thermal state</p> <p>This thermal estimation is provided by a probe fitted on the heatsink.</p> <p>The value 100 % represents the Nominal thermal state.</p> <ul style="list-style-type: none"> • <u>Warning:</u> <ul style="list-style-type: none"> ◦ A warning [Device Th Warn] THA is raised if [Device Thermal State] > 110%. ◦ The warning will be cleared if [Device Thermal State] < 105%. • <u>Error:</u> <ul style="list-style-type: none"> ◦ An error [Device Overheat] OHF is triggered if [Device Thermal State] THS > 118%. ◦ The error can be reset if [Device Thermal State] THS < 100%. 		

Counter Management

This menu provides the parameters to monitor the counters and reset them.

Access path: **[Display] → [Counter Management]**

HMI label	Display	Factory setting
[Motor Run Time] <small>RTHH</small>	0...119304.6 h	0
Motor run time This parameter monitors how long the motor has been energized.		
[Power-on time] <small>PTHH</small>	0...119304.6 h	–
Power-on time This parameter monitors how long the soft starter has been powered-on (control block supplied).		
[Nb Of Starts] <small>NSM</small>	0...4294967295	–
Number of motor starts		
[Bypass Life Cycle] <small>BPCL</small>	0...100%	–
Bypass contactor life cycle rate Percentage of bypass cycles compared to maximum cycles.		

Access path: **[Display] → [Counter Management]**

OR **[Display] → [Energy parameters]**

HMI label	Display	Factory setting
[Counter Reset] <small>RPR</small>	–	[No] <small>NO</small>
Counter reset Set the parameter to :		
<ul style="list-style-type: none"> • [No]: No counter reset. • [Reset Cons] to reset the counters of the energy consumption. • [Reset Run Time] to reset the counter displaying how long the motor has been energized. • [Reset Pw On Time] to reset the counter displaying how long the soft start has been powered-on. • [Reset Fan Count] to reset the counter displaying how long the fans have been powered-on. • [Reset Start Count] to reset the number of motor starts counter. • [Voltage Sag Counter]: Reset voltage sag counter. • [Reset All]: Reset all counters. 		

Other States

Access path: **[Display]** → **[Other State]** SST

This menu displays status or state of some applications functions:

- **[Anti-Jam pending]**
- **[Anti-Jam In Progress]**
- **[Automatic restart]**: Automatic restart attempts in progress.
- **[Type of stop]**: Stop following value set to **[Type of stop]**.
- **[Bypass Active]**: Bypass active.
- **[Braking Active]**: Braking active.
- **[Steady State]**: Steady state reached.
- **[Forward]**
- **[Reverse]**
- **[Wait Before Restart]**: Time before restarting.
- **[2nd Motor Selected]**: 2nd set of motor parameters activation.
- **[Small Motor Test]**
- **[Simu Mode Active]**: Simulation Mode is active.
- **[Jog Activation]**
- **[Boost Active]**

Input & Output Map

This menu provides the parameters to monitor the functions assigned to the inputs / outputs of the soft starter.

This menu is divided into several sub-menus:

- **[Digital Input Map]**: The mapping of the digital inputs.
- **[Analog inputs image]**: The image of the analog inputs.
- **[Digital Output Map]**: The mapping of the digital outputs and relays.
- **[Analog outputs image]**: The image of the analog outputs.

The parameters available in this menu are in read-only mode, they cannot be configured.

For more information on the inputs/outputs configuration, refer to the menu in **[Input/Output]**, page 202.

Access path: **[Display]** → **[I/O Map]**

[Digital Input Map]

This menu is used to display the state of digital inputs and of STO. Use the touch wheel to scroll through the digital inputs:

On the Display Terminal, select the digital input to see the function assigned to it. This can be used to verify the compatibility with the input/output assignments.

For more information on digital inputs refer to Digital Inputs Assignment, page 202.

[Analog inputs image]

This menu is used to display the state of analog inputs. Use the touch wheel to scroll through the analog inputs:

On the Display Terminal, select the analog input to see the function assigned to it. This can be used to verify the compatibility with the input/output assignments.

For more information on analog inputs refer to **[AI1 configuration]** AI1, page 206.

[Digital Output Map]

This menu is used to display the state of digital outputs and relays. Use the touch wheel to scroll through the digital outputs:

On the Display Terminal, select the digital output to see all the functions that are assigned to it. This can be used to verify the compatibility with the input/output assignments.

For more information on digital outputs refer to DQ1 & DQ2 Configuration, page 204, R1 Configuration, page 209, and R2 and R3 Configuration, page 210.

[Analog outputs image]

This menu is used to display the state of analog outputs. Use the touch wheel Up/Down arrows to scroll through the analog outputs:

On the Display Terminal, select the analog output to see all the functions that are assigned to it. This can be used to verify the compatibility with the input/output assignments.

For more information on analog outputs refer to [AQ1 Configuration](#), page 207.

Energy parameters

This menu provides the parameters to monitor energy consumption.

Access path: **[Display]** → **[Energy parameters]**

HMI label	Display	Factory setting
[Acv Elc Out Pwr in kW] <small>EPRW</small>	0...(1) kW	–
Active Electrical output power in kW		
(1): Max value depends on soft starter rating (see NPR power scaling through communication).		
[Peak Elec Out Power] <small>MOEP</small>	0...(1) kW	–
Maximum value of electrical power consumed.		
(1): Max value depends on soft starter rating (see NPR power scaling through communication).		
[Elc Energy Cons] <small>OC4</small>	0...999 TWh	–
Electrical energy consumed by the motor in TWh.		
[Elc Energy Cons] <small>OC3</small>	0...999 GWh	–
Electrical energy consumed by the motor in GWh.		
[Elc Energy Cons] <small>OC2</small>	0...999 MWh	–
Electrical energy consumed by the motor in MWh.		
[Elc Energy Cons] <small>OC1</small>	0...999 kWh	–
Electrical energy consumed by the motor in kWh.		
[Elc Energy Cons] <small>OC0</small>	0...999 Wh	–
Electrical energy consumed by the motor in Wh.		
[Elc Egy Today] <small>OCT</small>	0...4,294,967,295 kWh	–
Electrical energy consumed today by the motor in kWh.		
[Elc Egy Yesterday] <small>OCY</small>	0...4,294,967,295 kWh	–
Electrical energy consumed yesterday by the motor in kWh.		
[Reactive Energy] <small>IRE4</small>	0...999 TVArh	–
Reactive energy produced by the motor in TVArh.		
[Reactive Energy] <small>IRE3</small>	0...999 GVArh	–
Reactive energy produced by the motor in GVArh.		
[Reactive Energy] <small>IRE2</small>	0...999 MVArh	–
Reactive energy produced by the motor in MVArh.		
[Reactive Energy] <small>IRE1</small>	0...999 kVArh	–
Reactive energy produced by the motor in kVArh.		
[Reactive Energy] <small>IRE0</small>	0...999 VArh	–
Reactive energy produced by the motor in VArh.		
[Counter Reset] <small>RPR</small>	–	[No] <small>NO</small>
Counter reset		
Refer to Counter Management , page 263.		

Diagnostics and Troubleshooting

What's in This Part

LED status	269
Diagnostic Data	271
Error History	274
Warnings	276
Fan diagnostic	277
Error and Warning Handling	279
Security Event Logging	283
Troubleshooting	285
Warning messages and error codes.....	287

This menu provides the error and warning history of the soft starter.

LED status

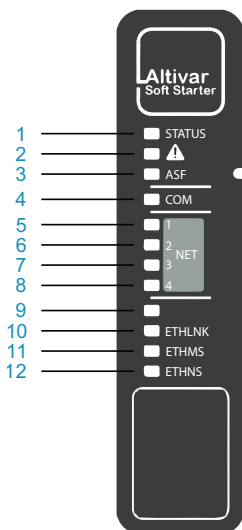

Item	LED		Description
1	STATUS	OFF	Indicates that the soft starter is not ready to start
		Green flashing	Indicates that the soft starter is not running, ready to start
		Green blinking	Indicates that the soft starter is in transitory status (acceleration, deceleration, and so on)
		Green on	Indicates that the soft starter is running
		Yellow on	Indicates that the soft starter localization is in progress
2	Warning/Error	Red flashing	Indicates that the soft starter has detected a warning
		Red on	Indicates that the soft starter has detected an error
3	ASF	OFF	Indicates Safety Function STO is not active.
		Yellow on	Indicates Safety Function STO is triggered.
4	COM	Yellow flashing	Indicates Modbus serial activity on port Modbus VP12S port.
5	NET 1	Green/Yellow	NET 1...NET 4 leds are available only for optional fieldbus. For more details, refer to the dedicated fieldbus manual.
6	NET 2	Green/Red	
7	NET 3	Green/Red	
8	NET 4	Green/Yellow	
9	Reserved		
10	ETHLNK	Green/Yellow	Indicates port activity
11	ETHMS	Green/Red	Indicates module status.
12	ETHNS	Green/Red	Indicates network status

ETHNS Network status

This LED indicates the status of the Ethernet embedded fieldbus.

Color and status	Description
OFF	The device does not have an IP address or powered off
Blinking Green/Red	Power on testing
Green ON	A connection is established to control the command word
Blinking Green	Device has a valid IP, but no command word connection
Red ON	Duplicated IP
Blinking Red	An established connection to control the command word is closed or timed out

ETHMS Module status

This LED indicates the status of the Ethernet embedded fieldbus.

Color and status	Description
OFF	No power is supplied to the device
Blinking Green/Red	Power on testing
Green ON	The device is operating correctly.
Blinking Green	Device has not been configured.
Red ON	The device has detected a recoverable minor detected error.
Blinking Red	The device has detected a non-recoverable major detected error

Diagnostic Data

This menu provides the parameters to display the last warning and last detected error in addition to device data.

Access path: **[Diagnostics] → [Diag. data]**

HMI label	Setting	Factory setting
[Last Error] LFT	–	–
Last error occurred		
Last error which occurred. The list of error codes is available in the chapter How To Clear the Error Codes?, page 286.		
[Last Warning] LALR	–	–
Last warning		
Last warning which occurred. The list of warning codes is available in the chapter List of Available Warning Messages.		
[Error Info (INF6)] INF6	–	–
Internal error 6 (Module identification error) information		
This parameter can be accessed only if [Internal Error 6] INF6 error is triggered. For more information, refer to [Internal Error 6] , page 303.		
[Cust Supply Diag] CPSF		
Customer supply error diagnostic		
<ul style="list-style-type: none"> 0x00: No power supply error detected since startup 0x11: Overcurrent detected on customer 24V supply 0x21: Overvoltage detected on customer 24V supply 0x31: Too many short under-voltages detected on customer 24V supply 		
This parameter can be accessed only if [Cust Supply Error] CPSF error is triggered.		
[Service Message] SER	–	–
This menu presents the service message.		
This service message is defined using [My preferences] → [Customization] → [Service Message] menu.		
[LED Diagnostics] HLT	–	–
This starts a test sequence to verify the states of the LEDs.		
[Customer Supply 24V] SUP1	0.0...6553.5 V	–
24V customer supply monitoring		
[Control Supply 24V] SUP2	0.0...6553.5 V	–
24V control supply monitoring		
[Control Supply 13V] SUP3	0.0...6553.5 V	–
12V (from RJ45) supply monitoring		
[Power Supply 12V] SUP6	0.0...6553.5 V	–
12V power supply monitoring		
[Clear Error History] RFLT	[No] or [Yes]	[No]
Clear error history		
<ul style="list-style-type: none"> [No]: Do not clear error history. [Yes]: Clear error history. 		

HMI label	Setting	Factory setting
[Phase Loss Status] OPFS	–	–
<p>Status on the loss of the motor phases. Only available in RDY, RUN and BYP states.</p> <ul style="list-style-type: none"> • [No Phase Loss] = No Phase Loss • [Loss of Phase 1] = phase 1 loss • [Loss of Phase 2] = phase 2 loss • [Loss of Phase 1&2] = phase 3 loss • [Loss of Phase 3] = phase 1 & 2 Loss • [Loss of Phase 1&3] = phase 1 & 3 Loss • [Loss of Phase 2&3] = phase 2 & 3 Loss • [All Phases Loss] = phase 1,2 & 3 Loss • [Undef Phase Loss] = phase loss not determined • [Result Not Available] = result not available 		
[Mains Loss Status] PHFS	–	–
<p>Status on the loss of the mains phases. The power supply A1/A2 must be powered up to start this function..</p> <ul style="list-style-type: none"> • [No Phase Loss] = No Phase Loss • [Loss of Phase 1] = phase 1 loss • [Loss of Phase 2] = phase 2 loss • [Loss of Phase 1&2] = phase 3 loss • [Loss of Phase 3] = phase 1 & 2 Loss • [Loss of Phase 1&3] = phase 1 & 3 Loss • [Loss of Phase 2&3] = phase 2 & 3 Loss • [All Phases Loss] = phase 1,2 & 3 Loss • [Undef Phase Loss] = phase loss not determined • [Result Not Available] = result not available 		
[Mains Loss Location] GRDS	–	–
<p>Input phase loss location in delta</p> <ul style="list-style-type: none"> • [No Grid Loss] NO • [At Mains input] GRDA: Input phase loss before motor cable feedback (location A on wiring diagram). • [At Starter Mains Term] GRDE: Input phase loss after motor cable feedback (location E on wiring diagram). • [Not Available] NA= result not available (In Line wiring). <p>NOTE: If [Phase Loss Monit] PHP is set on [No], [Undefined Location] UNK will be monitoring and [Mains Loss Location] won't be displayed.</p> <p>This parameter can be accessed only if [Inside Delta] is set to [Yes].</p>		

HMI label	Setting	Factory setting
[Bypass Life Cycle] BPCL	0...100%	–
Percentage of bypass cycles compared to maximum cycles.		
[Bypass Diagnostics] BPED	–	–
Bypass Error Diagnostic: <ul style="list-style-type: none"> • [Bypass Operational] • [Contactor 1 Error] : Bypass 1 Error • [Contactor 2 Error] : Bypass 2 Error • [Contactor 1&2 Error] : Bypass 1 and 2 Error • [Contactor 3 Error] : Bypass 3 Error • [Contactor 1&3 Error] : Bypass 1 and 3 Error • [Contactor 2&3 Error] : Bypass 2 and 3 Error • [All Contactors Error] : Bypass 1, 2 and 3 Error • [Undef Bypass Error] : Bypass Error not determined • [Result Not Available] 		
[Product restart] RP	–	[Not Assigned] NO
Product restart For more information, refer to Product Restart, page 218.		

Error History

This menu shows the 15 last detected errors. Pressing **OK** key on the selected error code in the **[Error history]** list displays the soft starter data recorded when the error has been detected.

Errors are stored and time-stamped on the soft starter. This information is displayed on the graphic display terminal, and can be downloaded and viewed in the DTM as well as on the web server.

NOTE: Same content for **[Last Error 1]** to **[Last Error 15]**.

NOTE: How To Clear the Error Code is available in the chapter How To Clear the Error Codes?, page 286.

Access path: **[Diagnostics]** → **[Errors]**

The following table shows the detailed information stored before the **[Last Error 1]** triggered:

HMI label	Setting	Factory setting
[Device State] <i>HS1</i>	–	–
HMI status of the error record 1.		
[Last Error 1 Status] <i>EP1</i>	–	–
Status word of the error record 1.		
[ETI state word] <i>IP1</i>	–	–
Extended status word of the error record 1.		
[Cmd word] <i>CMP1</i>	–	–
Command word of the error record 1.		
[Motor current] <i>LCP1</i>	–32767...32767 A Unit: 0.1 A. or 1 A according to the soft starter rating.	–
Current motor value (RMS) of the error record 1.		
[Run Elapsed time] <i>RTP1</i>	0..65535 h	–
Run time of the error record 1.		
[Motor therm state] <i>THP1</i>	0...300 %	–
Motor thermal state of the error record 1. This parameter monitors the motor thermal state. 100% corresponds to the nominal thermal state at the nominal motor current set to [Motor Nom Current] .		
[Command Channel] <i>DCC1</i>	–	–
Channel command active of the error record 1. <ul style="list-style-type: none"> [Terminals] <i>TER</i>: terminal channel. [HMI] <i>LCC</i>: Graphic display channel. [Modbus] <i>MDB</i>: Modbus channel. [CANopen] <i>CAN</i>: CanOpen channel. [Com. Module] <i>NET</i>: Option board channel. [Eth Embedded] <i>ETH</i>: ETH Module (Ethernet embedded). [PC tool] <i>PWS</i>: DTM based commissioning software. 		
[Motor Torque] <i>OTP1</i>	0...255 % of the nominal torque	–
Motor torque of the error record 1.		

HMI label	Setting	Factory setting
[Device Thermal State] TSP1	0...200%	–
Device thermal state of the error record 1. The value 100 % represents the Nominal thermal state.		
[Warn Group Status] AGP1	–	–
Warning group status of the error record 1. List of possible warning is available, page 285.		
[Mains Max Inst. Volt.] ULM1	–	–
Maximum Voltage value of error record.		

Warnings

This menu presents the current warnings and warning history. The list of warning codes is available in the chapter List of Available Warning Messages, page 289.

NOTE: Any warning that is triggered but is not assigned to a warning group will not be visible on the display terminal, will not be signaled by the LED of the soft starter and will not be logged.

Access path: **[Diagnostics] → [Warnings]**

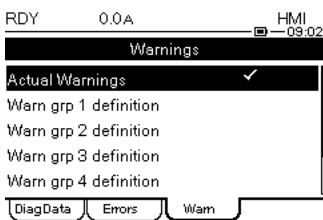
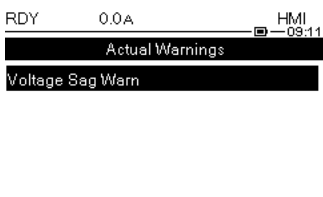
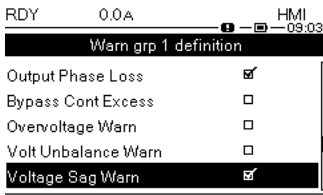
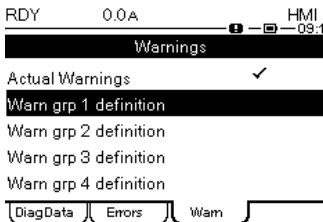
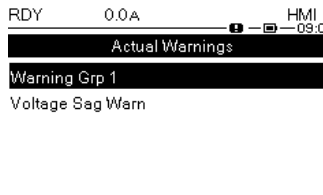
HMI label	Setting	Factory setting
[Actual Warnings] ALRD	—	—
<p>List of current warnings.</p> <p>If warning is active and not in warning group, only ✓ is displayed:</p> <div style="display: flex; justify-content: space-around;">   </div> <p>If warning is active and in warning group ✓ and [] are displayed:</p> <div style="display: flex; justify-content: space-around;">    </div>		
[Warn grp 1 definition] A1C to [Warn grp 5 definition] A5C	—	—
<p>The following submenus groups the warnings into 1 to 5 groups, each of which can be assigned to a relay or a digital output for remote signalling.</p> <p>When one or several warning(s) selected in a group occur(s), this actual warning and the output are activated.</p>		
[Warning History] ALH	—	—
<p>This menu presents the warning history (30 past warnings).</p> <p>Warnings are stored and time-stamped on the soft starter. This information is displayed on the graphic display terminal, and can be downloaded and viewed in the DTM as well as on the web server.</p>		

Fan diagnostic

What's in This Chapter

Fan status..... 277
 Fan diagnostics test..... 278
 Fan Counter Reset 278

NOTE: This menu is not available for product size lower than ATS490D75Y.

Fan status

Access path: **[Diagnostics] → [Fan diagnostic] → [Fan status]**

HMI label	Setting range	Factory setting
[Fan status register] <i>FPAD</i>	-	-
<p>Fan operating status register An event means that a warning on fan speed or operating time of the fan is elapsed and therefore tells which fan to check.</p> <ul style="list-style-type: none"> • [No Warning] • [Event On Fan 1] • [Event On Fan 2] • [Event On Fans 1&2] • [Event On Fan 3] • [Event On Fans 1&3] • [Event On Fans 2&3] • [Event On All Fans] • [Undefined Fan Event] • [Result Not Available] 		
[Fan 1 status] <i>FFA1</i> [Fan 2 status] <i>FFA2</i> [Fan 3 status] <i>FFA3</i>	-	-
<p>Fan 1 operating status, Fan 2 operating status, Fan 3 operating status</p> <ul style="list-style-type: none"> • [OK]: no event • [Warning]: event of low speed or operating time of the fan elapsed. • [Error]: event of very low speed (near 0 rpm). 		
[Fan 1 run time] <i>FPT1</i> [Fan 2 run time] <i>FPT2</i> [Fan 3 run time] <i>FPT3</i>	0...500000 h	-
<p>Fan 1 operating time, Fan 2 operating time, Fan 3 operating time</p>		
[Fan 1 speed] <i>FSP1</i> [Fan 2 speed] <i>FSP2</i> [Fan 3 speed] <i>FSP3</i>	0...65535 rpm	-
<p>Fan 1 operating speed, Fan 2 operating speed, Fan 3 operating speed</p>		
[Fan Run Time Thld] <i>FPTA</i>	[Default]; 1...65535 h	[Default]
<p>Fan operating time threshold Threshold on the number of hours of operating time to generate an error [Fan Feedback Error] <i>FFDF</i>.</p>		

Fan diagnostics test

Access path: **[Diagnostics]** → **[Fan diagnostic]** → **[Fan Diagnostics Test]**

HMI label	Setting range	Factory setting
[Fan Diagnostics test] <small>FNT</small>	-	-
<p>A test of fans can be launched to check operation of the fans functionality with [Fan Diagnostics test].</p> <ul style="list-style-type: none"> The diagnostic can only be run in Stop mode. The diagnostic consists in Force turning ON the Fans for 40s (do not press ESC during this time) and checks : <ul style="list-style-type: none"> Each fan speed : <ul style="list-style-type: none"> If speed is above the normal operation limit, the result is [OK].. If speed is between minimum and maximum operation limit, the result is [Warning]. If speed is below the minimum operation limit, the result is [Error]. Each fan stop, result is NOK if fan does not stop. The diagnostic results of each fan are given in [Fan Diagnostics test]: <ul style="list-style-type: none"> [Fan Diagnostics test] indicates results of: <ul style="list-style-type: none"> [Fan1 Speed Warn sts]: Fan 1 low speed. [Fan1 Speed Error sts]: Fan 1 not stopping. [Fan1 No Speed sts]: Fan 1 no speed. [Fan2 Speed Warn sts]: Fan 2 low speed. [Fan2 Speed Error sts]: Fan 2 not stopping. [Fan2 No Speed sts]: Fan 2 no speed. [Fan3 Speed Warn sts]: Fan 3 low speed. [Fan3 Speed Error sts]: Fan 3 not stopping. [Fan3 No Speed sts]: Fan 3 no speed. [Fan Diagnostics test] is reset at each test. 		

Fan Counter Reset

This menu is used to reset fan counters.

Access path: **[Diagnostics]** → **[Fan diagnostic]** → **[Counter reset]**





HMI label	Setting range	Factory setting
[Reset Fan 1 Run Time] <small>FTR1</small>	[No] or [Yes]	[No]
<i>Reset fan 1 operating time</i>		
[Reset Fan 2 Run Time] <small>FTR2</small>	[No] or [Yes]	[No]
<i>Reset fan 2 operating time</i>		
[Reset Fan 3 Run Time] <small>FTR3</small>	[No] or [Yes]	[No]
<i>Reset fan 3 operating time</i>		





Error and Warning Handling

This menu provides the parameters to manage the errors and warnings handling.

Access path: **[Complete settings] → [Error/Warn handling]**

HMI label	Setting	Factory setting
[Ext Error assign] <i>ETF</i>	–	[Not Assigned] <i>NO</i>
<p>External error assignment</p> <p>This parameter assigns the detection of the [External Error] <i>EPF1</i> error to a digital or a virtual input.</p> <ul style="list-style-type: none"> [Not Assigned]: External error not assigned. [DI●]: External error assigned to digital input [DI●] (high and low level). [CD●●]: External error assigned to line channel. Refer to the fieldbus manuals for the CMD word assignments. <p>When [Ext Error assign] is set to high level, accidental disconnection of the cable connected to the digital input assigned to [Ext Error assign] is not detected.</p> <div style="border: 1px solid black; padding: 5px; text-align: center;"> <p>⚠ WARNING</p> <p>LOSS OF CONTROL</p> <ul style="list-style-type: none"> Verify that the setting of this parameter does not result in unsafe conditions. Select a digital input active at low level if you want to detect accidental disconnection of the cable connected to the digital input. <p>Failure to follow these instructions can result in death, serious injury, or equipment damage.</p> </div>		
[Ext Error Resp] <i>EPL</i>	–	[Freewheel Stop] <i>YES</i>
<p>Device response to external error</p> <p>NOTE: [Ext Error Resp] appears if [Ext Error assign] is assigned.</p> <p>This parameter sets the behavior on External error condition:</p> <ul style="list-style-type: none"> [Ignore]: Trigger [Ext. Error Warn] <i>EFA</i>. The warning should be assigned to a warning group in [Warn groups config] to be visible when triggered. Refer to Warning Messages, page 289. [Freewheel Stop]: Error [External Error] <i>EPF1</i> is triggered and motor stops in freewheel. [Configured Stop]: Motor stops according to the value set in [Type of stop], [Ext. Error Warn] <i>EFA</i> is triggered. [Deceleration]: Motor stops in deceleration and an error [External Error] <i>EPF1</i> is triggered at the end of deceleration. [Braking]: Motor stops in dynamic braking stop and an error [External Error] <i>EPF1</i> is triggered at the end of stop. 		

HMI label	Setting	Factory setting
[Auto Fault Reset] 	–	[No] NO
<p>Automatic fault reset</p> <p>This parameter enables the automatic reset of the soft starter after the triggered error has been cleared.</p> <p>For more information about errors codes affected by [Auto Fault Reset], refer to Troubleshooting, page 285.</p> <ul style="list-style-type: none"> [No]: disables automatic reset. [Yes]: allows automatic reset. <p>This function can be used to automatically perform individual or multiple Fault Resets. If the cause of the error that has triggered the transition to the operating state Fault disappears while this function is active, the device resumes normal operation. While the Fault Reset attempts are performed automatically, the output signal "Operating state Fault" is not available. If the attempts to perform the Fault Reset are not successful, the device remains in the operating state Fault and the output signal "Operating state Fault" becomes active.</p>		
<p>▲ WARNING</p>		
<p>UNANTICIPATED EQUIPMENT OPERATION</p> <ul style="list-style-type: none"> Verify that activating this function does not result in unsafe conditions. Verify that the fact that the output signal "Operating state Fault" is not available while this function is active does not result in unsafe conditions. <p>Failure to follow these instructions can result in death, serious injury, or equipment damage.</p>		
<p>The relay assigned to [Operating State Fault] remains closed if this function is running as long as [Fault Reset Time] is not elapsed.</p> <p>To be able to perform an automatic restart of the motor after an automatic reset of the error, use:</p> <ul style="list-style-type: none"> 2–wire control (2C) in Level configuration, page 49 2–wire control (Legacy mode), page 50. 		
[Fault Reset Time] 	–	[5 minutes] 5
<p>Fault Reset time</p> <p>This parameter sets the maximum time for a successful automatic reset when it is configurable.</p> <p>For more information about errors codes affected by [Auto Fault Reset], refer to Troubleshooting, page 285.</p> <p>If [Fault Reset Time] is elapsed before a successful automatic reset, the soft starter can only be reset with a manual reset.</p> <ul style="list-style-type: none"> [5 minutes]: 5 minutes for successful automatic restart [10 minutes]: 10 minutes for successful automatic restart [30 minutes]: 30 minutes for successful automatic restart [1 hour]: 1 hour for successful automatic restart [2 hours]: 2 hours for successful automatic restart [3 hours]: 3 hours for successful automatic restart [Unlimited]: Unlimited time for successful automatic restart <p>This parameter can be accessed if [Auto Fault Reset] is set to [Yes].</p>		
[Disable Error Detect] 	–	[Not Assigned] NO
<p>For more information, refer to Smoke Extraction, page 174.</p>		
[Forced Run] 	–	[Disabled] NO
<p>For more information, refer to Smoke Extraction, page 174.</p>		

HMI label	Setting	Factory setting
[Fault Reset Assign]  RSF	–	[Not Assigned] NO
<p>Fault reset input assignment</p> <p>If no digital input is set, a manual reset is possible by applying a Forward/Reverse order.</p> <ul style="list-style-type: none"> • [Not Assigned]: Manual reset not assigned. • [DI●]: Manual reset assigned to digital input [DI●] on rising edge. <p>NOTE: in [Standard Profile], the BIT 7 of the CMD register is assigned to [Fault Reset Assign]. For more information, refer to communication manuals.</p> <p>NOTE: In [I/O profile], [Fault Reset Assign] can be assigned to a virtual input [CD●●].</p>		
[Product restart]  RP	–	[Not Assigned] NO
<p>Product restart</p> <p>For more information, refer to Product Restart, page 218.</p>		
[Prod Restart Assign]  RPA 	–	[Not Assigned] NO
<p>Product restart assignment</p> <ul style="list-style-type: none"> • Product restart is performed on transition of the selected DI to the active level: <ul style="list-style-type: none"> ◦ [Not Assigned]: <i>Product restart assignment</i> not assigned. ◦ [DI●]: <i>Product restart assignment</i> assigned to digital input [DI●]. • The product can only be restarted when not running. If motor is running when order is received, command is ignored. • During this restart procedure, the product goes through the same steps as if it had been switched off and on again. <p>The Restart function performs a Fault Reset and then restarts the device. During this Restart procedure, the device goes through the same steps as if it had been switched off and on again. Depending on the wiring and the configuration of the device, this may result in immediate and unanticipated operation.</p> <div style="border: 1px solid black; padding: 10px; text-align: center;"> <p>⚠ WARNING</p> <p>UNANTICIPATED EQUIPMENT OPERATION</p> <p>The Restart function performs a Fault Reset and restarts the device.</p> <ul style="list-style-type: none"> • Verify that activating this function does not result in unsafe conditions. <p>Failure to follow these instructions can result in death, serious injury, or equipment damage.</p> </div>		
[Control Supply Loss]  CLB	–	[Error] 0
<p>Response to control supply loss</p> <p>This parameter sets the soft starter behavior when the control supply on A1 and A2 is out of range.</p> <ul style="list-style-type: none"> • [Error]: Triggers the [Control Supply Error] error. Opens the relay R1 if it is assigned to [Operating State Fault] and if [Auto Fault Reset] is set to [No]. • [Error w/o Relay]: Triggers the [Control Supply Error] error and keeps the relay assigned to [Operating State Fault] closed. • [Warning]: triggers the [Ctrl Supply Loss] warning instead of triggering [Control Supply Error]. <p>NOTE:</p> <p>The [Ctrl Supply Loss] warning will trigger only if:</p> <ul style="list-style-type: none"> • If is added to a warning group definition in [Diagnostics] → [Warnings]. • The soft starter loses the control supply on A1 / A2 while not in operating state [Running]. Otherwise the [Control Supply Error] will trigger instead. 		

[Warn groups config]

Access path to assigned a warning:

- **[Diagnostics] → [Warnings]**
- **[Complete settings] → [Error/Warn handling] → [Warn groups config]**

This sub-menu sets the configuration of the following warning groups:

- **[Warn grp 1 definition].**
- **[Warn grp 2 definition].**
- **[Warn grp 3 definition].**
- **[Warn grp 4 definition].**
- **[Warn grp 5 definition].**

When a warning is triggered, the relay or digital output set to the triggered warning group is activated.

NOTE: Any triggered warning that is not assigned to a warning group will not be visible on the graphic display terminal, will not be signaled by the LED of the soft starter and will not be logged.

NOTE: A list of possible warning is available here: [List of Available Warning Messages](#), page 289.

Security Event Logging

The following time-stamped events are logged in a dedicated security log file:

- User authentications, authentication and logout attempts
- Security parameter changes
- Access to the security events
- Device reboot, startup
- Device hardware modifications and software updates
- Device Configuration Integrity changes (restore, download or factory settings)

The Altivar Soft Starter ATS490 can store up to 500 events, a warning is raised when the log base is reaching 90% of capacity. This warning can be acknowledged with commissioning tool (DTM). When the maximum capacity is reached, the 50 oldest events are erased.

It is recommended to acknowledge the security event logs every 3 months to prevent the loss of logging information.

This operation can be done via DTM, only for user with Admin rights.

If access control is disabled, any security event is identified as “anonymous” action.

Embedded Device provides the capability to determine whether a given human took a particular action. The link is established between the user identifier, the action realized and the timestamping of the action (date and time) to provide an efficient source of security logging.

Irrelevant date & time can result in false interpretation of the security event logging and lead to either false positive or undetectable security threat detection.

NOTICE

WRONG TIMESTAMPING RESULT IN NON-REPUDIATION ISSUE

- Verify and regularly realign the synchronization of the device data & time.

Failure to follow these instructions can result in equipment damage.

The security events can be read from SoMove, DTM and EcoStruxure Control Expert. For security reasons, security logs are stored in a database to which read-only access is provided. There is no possibility to edit this log database.

The format system log record follows the syntax defined by Syslog RFC–5424 2009 and the semantic normalized by Schneider Electric.

Below is an example of this format:

```
<86>1 2024-01-24T09:59:53.06Z MyDevice ATS490 Credential USERACCOUNT_CHANGE [cred@3833 name="ADMIN"] Password changed
```

Elements from the example, from left to right	Syslog word	Description
<86>	PRI	Event priority (81 for alert events, 85 for notice events, 86 for informational events)
1	VERSION	Syslog protocol version
2024-01-24T09:59:53.06Z	TIMESTAMP	Date and time in UTC
MyDevice	HOSTNAME	Device name, or serial number if [Device Name] PAN is not defined
ATS490	APP-NAME	Product commercial reference
Credential	PROCID	Identify the process and the network protocol service that originated the message
USERACCOUNT_CHANGE	MSGID	Identify the type of event
[cred@3833 name="ADMIN"]	STRUCTURED-DATA	Event information depending on the event category: <ul style="list-style-type: none"> [authn@3833] [authz@3833] [config@3833] [cred@3833] [system@3833] [backup@3833]
Password changed	MSG	Message containing event specific information, if any

Troubleshooting

Soft Starter Does Not Start, No Error Code Displayed

1. If no display: verify the soft starter supply.
2. Check if **[No Mains Voltage]** **NLP** appears on the graphic display terminal. Verify the presence of power.

NOTE: If a line contactor is used, check if the power is present at the inputs.
3. Soft starter maybe blocked in **[Freewheel]** **NST** state. Refer to How to interpret and react to a NST state, page 327.
4. Soft starter maybe blocked in **[Wait for Restart]** **TBS** state. Refer to How to interpret and react to a TBS state, page 328.

Soft Starter Does Not Start, Error Code Displayed

Step	Action
1	Disconnect all power, including external control power that may be present.
2	Lock all power switches in the open position.
3	Verify the absence of voltage using a properly rated voltage sensing device.
4	Find and correct the cause of the detected error. Refer to the list of possible detected errors.
5	Restore power to the soft starter to confirm that the detected error has been cleared.

When an error is triggered the Warning/Error led is red on.

The soft starter behavior can be set for the following errors:

- **[Fdbus Interrupt Resp]** **CLL**
- **[CANopen Error Resp]** **COL**
- **[Ext Error Resp]** **EPL**
- **[Eth Error Response]** **ETHL**
- **[Freq Error Resp]** **FRFB**
- **[Voltage Error Resp]** **MVFB**
- **[Overload ErrorResp]** **ODL**
- **[Modbus Error Resp]** **SLL**
- **[Long Start Error Resp]** **STB**
- **[AI1 Th Error Resp]** **TH1B**
- **[Underload ErrorResp]** **UDL**

For all other detected errors the soft starter stop in freewheel.

How To Clear the Error Codes?

The following table summarizes the possibilities to clear a detected error:

How to clear the error code after the cause has been removed	List of the cleared errors
<p>Power reset:</p> <ul style="list-style-type: none"> Power reset of the soft starter. [Product restart] or [Prod Restart Assign] used. 	All detected errors.
<p>Manual reset:</p> <p>Perform one of the following actions to reset the device:</p> <ul style="list-style-type: none"> Press STOP / RESET key, if the active command channel is the terminal. Apply a rising edge to the digital input assigned to [Fault Reset], if the active command channel is the terminal. Activate the digital input <i>RUN</i> if [Fault Reset] is not assigned. Activate the digital input <i>RUN</i> a second time to start the motor. Consider the value set to the active command channel is the terminal. In case of line channel action must be done through CMD (see the communication manual). 	<p>DLTF, DWF, EPF1, EPF2, OHF, OLF, SLF1, SMPF, TJF, TLSF</p> <p>And all the error codes belonging to the following categories, after the automatic reset time is elapsed:</p> <ul style="list-style-type: none"> Automatic reset Automatic reset limited duration Automatic reset limited retry and limited duration
<p>Automatic reset:</p> <ul style="list-style-type: none"> A series of automatic attempts are made to reset the error at given intervals for an unlimited time or number of attempts. [Auto Fault Reset] must be set to [Yes] In case of [Supply Mains OverV] OSF or [Supply Mains UnderV] USF, the relay assigned to [Operating State Fault] does not open. 	CLF, OSF, USF
<p>Automatic reset limited duration:</p> <ul style="list-style-type: none"> A series of automatic attempts are made to reset the error with a maximum time for a successful automatic reset set with [Fault Reset Time] TAR [Auto Fault Reset] must be set to [Yes] At the end of the attempt, if the error is still present, the device remains in error state, and if a relay is assigned to [Operating State Fault], it is opened. a manual reset or a power reset is then required. 	CNF, COF, ETHF, FDR1, INFB, JAMF, SLF2, SLF3, T1CF, TH1F, ULF
<p>Automatic reset limited duration and limited retry:</p> <ul style="list-style-type: none"> A series of automatic attempts are made to reset the error at given intervals for a configured time [Fault Reset Time] TAR before disabling the sequence if the current error persist. [Auto Fault Reset] must be set to [Yes] At the end of attempt, if the error is still present, the device remains in error state and if a relay is assigned to [Operating State Fault], it is opened. A manual reset is then required. [Fault Reset Time] is limited to 3 hours. The error is logged only once during [Fault Reset Time], the first time the error occurs. <p>During [Fault Reset Time], any new occurrence of a given error is considered a new attempt (if no other error has occurred in the meantime).</p>	FRF, LCCF, LCF, MDDF, NOSF, OLC, OPF, PHF, PIF, SDF
<p>Transient:</p> <ul style="list-style-type: none"> As soon as its cause has been removed. <p>NOTE: In the case of [Invalid Config], the relay assigned to [Operating State Fault] does not open.</p>	CFF, CFI, CFI2, FWER, FWMC, FWPF, HCF, HPF, INFZ, PGLF, SPFC, SPTF

Warning messages and error codes

What's in This Chapter

Warning Messages.....	289
[Line Short Circuit] BYF1	292
[Bypass Closing Error] BYF2	292
[Bypass Open Error] BYF3.....	292
[ByPass Overcurrent] BYF4	293
[Incorrect Config] CFF	293
[Invalid Config] CFI	293
[Conf Transfer Error] CFI2	294
[Control Supply Error] CLF	294
[Fdbus Com Interrupt] CNF	294
[CANopen Com Interrupt] COF	295
[CANopen Init Error] COLF	295
[Cust Supply Error] CPSF.....	295
[STO On Inside Delta] DLTF	296
[Delta Overvoltage] DLVF.....	296
[In Delta Wiring Error] DWF.....	296
[Ctrl Memory Error] EEF1.....	297
[Pwr Memory Error] EEF2	297
[External Error] EPF1	297
[Fieldbus Error] EPF2	298
[Embd Eth Com Interrupt] ETHF.....	298
[FDR 1 Error] FDR1	298
[Fan Feedback Error] FFDF	299
[Mains Freq Error] FRF	299
[FW Update Error] FWER.....	299
[No Power Comm Error] FWMC	300
[Fware Pairing Err] FWPF.....	300
[Boards Compat] HCF	300
[HW Topo Error] HPF	301
[Internal Link Error] ILF	301
[Internal Error 1] INF1	301
[Internal Error 3] INF3	302
[Internal Error 4] INF4	302
[Safety CPU error] INF5	302
[Internal Error 6] INF6	303
[Internal Error 8] INF8	303
[Internal Error 11] INF8	303
[Internal Error 14] INFE	304
[Internal Error 15] INFF	304
[Internal Error 21] INFL	304
[Internal Error 22] INFM	304
[Internal Error 25] INFP	305
[Internal Error 26] INFQ	305
[Internal Error 35] INFZ	305
[Anti Jam Error] JAMF	305
[Input Contact. Closed] LCCF.....	306
[Input Contactor] LCF	306
[Mains Direction Error] MDDF	306
[Mains Nom. Volt. Error] NOSF.....	307
[Overcurrent] OCF	307
[Device Overheat] OHF	307
[Process Overload] OLC.....	308
[Motor Overload] OLF	308
[Output Phase Loss] OPF.....	308
[Supply Mains OverV] OSF	308
[Prog Load Error] PGLF.....	309
[Prog Run Error] PGRF	309
[Input Phase Loss] PHF.....	309
[Phase Inversion] PIF	310
[Safety Func Error] SAFF	310
[Ground Short Circuit] SCF3	310
[SCR Sync Error] SDF	311
[Mdb Com Interrupt] SLF1	311

[PC Com Interrupt] SLF2.....	311
[HMI Com Interruption] SLF3	311
[Simu Mains Detected] SMPF.....	312
[Security Files Corrupt] SPFC.....	312
[Sec Policy Update Err] SPTF.....	312
[AI1 Th Sensor Error] T1CF.....	312
[AI1 Th Level Error] TH1F.....	313
[Device Overheat] TJF	313
[Too Long Start Err] TLSF	313
[Proc Underload] ULF	313
[Supply Mains UnderV] USF	314

Warning Messages

List of Available Warning Messages

Any warning that is triggered and assigned to a warning group, will be :

- signaled by the LED of the soft starter;
- signaled by the icon  on the graphic display terminal;
- logged in the warning history.

Access paths to assign to a warning group:

- **[Diagnostics] → [Warnings]**
- **[Complete settings] → [Error/Warn handling] → [Warn groups config]**

By default the following warnings are assigned to the **[Warn grp 1 definition]**,
page 282:



- **[PumpCycle warning]**
- **[Low Battery Warn]**
- **[No Battery Warn]**
- **[Invalid RTC Warn]**
- **[Nameplate Mismatch]**
- **[Mains Loss Warn]**
- **[Output Phase Loss]**
- **[Static Port/Serv Warn]**
- **[Serv. Access Auth.]**
- **[ByPass Ov.Curr Warn]**

Setting	Code	Description
[PumpCycle warning]	PCPA	Pump cycle warning , see Pumpcycle Monitoring, page 139.
[Anti-Jam Warn]	JAMA	Anti-Jam warning , see Anti-Jam, page 184.
[Device Th Warn]	THA	Device thermal state warning , see Monitor thermal measurements, page 262.
[Therm Junction Warn]	TJA	Thermal junction warning .
[Fan Counter Warn]	FCTA	Fan counter warning , see Fan diagnostic, page 277.
[Fan Fdbk Warn]	FFDA	Fan feedback warning , see Fan diagnostic, page 277.
[Ext. Error Warn]	EFA	External error warning , see Error and Warning Handling , page 279.
[UnderV Warn]	USA	Undervoltage warning , see Overvoltage & Undervoltage, page 141.
[Forced Run]	ERN	Device in forced run , see Smoke Extraction, page 174.
[Proc Undld Warn]	ULA	Process underload warning , see Process Underload , page 135.
[Proc Overload Warn]	OLA	Process overload warning , see Process Overload, page 133.
[Dev Th reached]	TAD	Device thermal threshold reached , see Monitor thermal measurements, page 262.
[Eth Internal Warn]	INWM	Ethernet Internal warning .
[AI1 Th Warning]	TP1A	AI1 thermal sensor warning , see Motor External Thermal Sensor, page 145.
[Motor Overload Warn]	OLMA	Motor overload warning .
[Low Battery Warn]	RBLA	Soft starter Low Battery warning , see Scheduled Servicing, page 316.
[No Battery Warn]	RBNA	Soft starter Battery not detected warning , see Scheduled Servicing, page 316.
[Invalid RTC Warn]	RTCA	Invalid RTC warning
[Bypass Warn]	BPA	Bypass warning
[Modbus Com Warn]	SLLA	Modbus comm interruption warning , see Modbus VP12S port configuration, page 241.
[Fieldbus Com Warn]	CLLA	Fieldbus comm interruption warning , see PROFIBUS fieldbus, page 254.
[CANopen Com Warn]	COLA	CANOpen comm interruption warning , see CANopen fieldbus, page 252.
[Inhibited Errors Warn]	INH	Inhibited errors warning , see Smoke Extraction, page 174.
[Temp Sens AI1 Warn]	TS1A	Temperature sensor AI1 warning , see Motor External Thermal Sensor, page 145.
[Mains Loss Warn]	PHF	Mains Loss warning .
[Output Phase Loss]	OPF	Output Phase Loss warning , see Phase Loss, page 140.
[Bypass Cont Excess]	BPCA	Recommended bypass contactor cycles exceeded , the bypass contactor cycles exceeded 90% of total service life.

Setting	Code	Description
[Overvoltage Warn]	OSA	Overvoltage warning , see Overvoltage & Undervoltage, page 141.
[Volt Unbalance Warn]	ULBA	Mains unbalance warning , see Unbalanced Voltage & Unbalanced Current, page 143.
[Voltage Sag Warn]	SAGA	Voltage sag detection warning , see Monitor voltage measurements, page 258.
[Voltage Inconsistent]	MTVA	Motor voltage vs. Mains inconsistency warn , see Set Motor Nameplate Parameters, page 151.
[Nameplate Mismatch]	MNIA	Nameplate Inconsistency Alarm , see Set Motor Nameplate Parameters, page 151.
[Curr Unbal Warn]	ILBA	Current unbalance warning , see Unbalanced Voltage & Unbalanced Current, page 143.
[Mains Freq Warn]	FRQA	Mains frequency warning , see Mains Frequency, page 143.
[Config Recover Warn]	CBRA	Configuration recovery warning , see .
[Sys. Log. Warning]	SLGA	System Log Warning , application and log limits is almost reached (or reached), logs must be downloaded. See Cybersecurity operating, page 223.
[Serv. Access Auth.]	SMSA	After-Services Access Authorized , After Sales Services tab enabled.
[FDR Set Serv Warn]	FDSA	FDR setting service warning.
[IP Set Serv Warn]	IPSA	IP setting service warning.
[RSTP Set Serv Warn]	RSSA	RSTP setting service warning.
[Static Port/Serv Warn]	PSSA	Static port/service warning.
[ByPass Ov.Curr Warn]	BYFA	Bypass Contactor Overcurrent Warning.



[Line Short Circuit] BYF1

Internal line short circuit error

 Probable Cause	Bypass contactor is closed or SCR is short circuited.
 Remedy	Contact your local Schneider Electric representative.
 Clearing the Error Code	This detected error requires a power reset.



[Bypass Closing Error] BYF2

Bypass contactor error when closing

 Probable Cause	Bypass relay blocked in opened state.
 Remedy	Contact your local Schneider Electric representative.
 Clearing the Error Code	This detected error requires a power reset.



[Bypass Open Error] BYF3

Bypass contactor error when opening

 Probable Cause	Bypass unwanted open error.
 Remedy	Contact your local Schneider Electric representative.
 Clearing the Error Code	This detected error requires a power reset.



[ByPass Overcurrent] BYF4

Bypass Contactor Overcurrent

	Probable Cause	<ul style="list-style-type: none"> This error is triggered only when the soft starter is bypassed and the motor current is over 2 times the soft starter rated current. Load too high (mechanical locking). <p>In case of multiple [ByPass Overcurrent] BYF4 or [Overcurrent] OCF errors triggered, the internal bypass relays may be damaged, leading to relays being stuck.</p>
	Remedy	<ul style="list-style-type: none"> Check the size of the motor/device/load. Check the stability of the application. Contact your local Schneider Electric representative.
	Clearing the Error Code	This detected error requires a power reset.



[Incorrect Config] CFF

Incorrect configuration

	Probable Cause	<ul style="list-style-type: none"> Option module has been changed for another fieldbus or removed. Control block replaced by a control block configured on a soft starter with a different rating. The current configuration is inconsistent.
	Remedy	<ul style="list-style-type: none"> Verify that the option module or the product are not damaged. In the event of the control block being changed deliberately, see the remarks below. Press the OK key to validate the message displayed on the display terminal. This action will set a return to factory settings. Or retrieve the backup configuration if it is valid.
	Clearing the Error Code	This detected error is cleared as soon as its cause has been removed.



[Invalid Config] CFI

Invalid configuration

	Probable Cause	Inconsistent, invalid, unauthorized or out-of-bound value written to a parameter via a fieldbus or communication link. The written value is rejected, the previous one is kept and this error is triggered.
	Remedy	<p>This error is automatically cleared after:</p> <ul style="list-style-type: none"> Writing a correct value on any parameters via communication or fieldbus link. Writing a correct value on any parameters via any HMI (display terminal, SoMove...). Reset to factory settings, new configuration transfer or configuration restoration.
	Clearing the Error Code	This detected error is cleared as soon as its cause has been removed.



[Conf Transfer Error] CFI2

Configuration transfer error

 Probable Cause	<ul style="list-style-type: none"> • The configuration transfer to the soft starter was not successful or interrupted. • The configuration loaded is not compatible with the soft starter.
 Remedy	<ul style="list-style-type: none"> • Verify the configuration loaded previously • Load a compatible configuration • Use a PC software commissioning tool to transfer a compatible configuration • Perform a factory setting <p>NOTE: When this error is triggered, the current security configuration is kept valid and applied.</p>
 Clearing the Error Code	<p>This detected error is cleared as soon as its cause has been removed.</p>



[Control Supply Error] CLF

Control supply error

 Probable Cause	<ul style="list-style-type: none"> • Loss of control power supply on A1 and A2 terminals. • Control power supply out of bounds.
 Remedy	<ul style="list-style-type: none"> • Verify the control supply is wired on the terminals A1 and A2. • In the case of an external +24V power supply, check the presence of the control supply voltage of terminals A1 and A2. It must be 110...230 Vac +10% – 15%. • In the case of an external +24V power supply, to prevent this error from triggering, disable the monitoring of A1 / A2 power supply loss by setting [Control Supply Loss] in the menu [Complete settings] → [Error/Warn handling] to [Warning]. This will instead triggers the warning [Ctrl Supply Loss] CLA without blocking the device.
 Clearing the Error Code	<p>This detected error can be cleared with the [Auto Fault Reset] or manually with the [Fault Reset Assign] parameter after its cause has been removed.</p>

[Fdbus Com Interrupt] CNF

Fieldbus communication interruption

 Probable Cause	<p>Communication interruption on fieldbus module.</p> <p>This error is triggered when the communication between the fieldbus module and the master (PLC) is interrupted.</p>
 Remedy	<ul style="list-style-type: none"> • Verify the environment (electromagnetic compatibility). • Verify the wiring. • Verify the timeout. • Replace the option module. • Contact your local Schneider Electric representative.
 Clearing the Error Code	<p>This detected error can be cleared with the [Auto Fault Reset] or manually with the [Fault Reset Assign] parameter after its cause has been removed.</p>

[CANopen Com Interrupt] COF

CANopen communication interruption

	Probable Cause	Communication interruption on the CANopen® fieldbus.
	Remedy	<ul style="list-style-type: none"> • Verify the communication fieldbus. • Verify the timeout • Refer to the CANopen® user manual
	Clearing the Error Code	This detected error can be cleared with the [Auto Fault Reset] or manually with the [Fault Reset Assign] parameter after its cause has been removed.

[CANopen Init Error] COLF

CANopen initialization error

	Probable Cause	CANopen could not initialize because the device baudrate is incompatible with the controller baudrate.
	Remedy	<ul style="list-style-type: none"> • Verify the device baudrate • Verify the baudrate of other devices on the network • If the error persists, disconnect the device from the network
	Clearing the Error Code	This detected error requires a power reset of the device after its cause has been removed.



[Cust Supply Error] CPSE

Customer supply error

	Probable Cause	<p>The error is triggered if the external 24VDC supply voltage is higher than the maximum DC voltage 30V, or lower than the minimum DC voltage 19V</p> <ul style="list-style-type: none"> • The external supply is not operating correctly. • The +24V terminal consumption has been greater than 200mA
	Remedy	<ul style="list-style-type: none"> • Verify the external 24VDC supply applied on the +24 terminal. • Verify the current on the +24 terminal. • Verify there is no short circuit between 0 and +24 terminal. • Check the value of the [Cust Supply Diag] parameter: <ul style="list-style-type: none"> ◦ Value = 0x00 : No power supply error detected since startup ◦ Value = 0x11 : Overcurrent detected on customer 24V supply ◦ Value = 0x21 : Overvoltage detected on customer 24V supply ◦ Value = 0x31 : Too many short undervoltages detected on customer 24V supply • Contact your local Schneider Electric representative.
	Clearing the Error Code	This detected error requires a power reset of the device after its cause has been removed.



[STO On Inside Delta] DLTF

STO activation on Inside the Delta wiring

 Probable Cause	STO incompatible with Inside The Delta wiring.
 Remedy	Disable STO input.
 Clearing the Error Code	This detected error can be cleared manually with the [Fault Reset Assign] parameter after its cause has been removed.



[Delta Overvoltage] DLVF

Delta Wiring Voltage error

 Probable Cause	In case of a Mains RMS Voltage greater than 500V (with 5% hysteresis) is detected, a [Delta Overvoltage] is raised.
 Remedy	<ul style="list-style-type: none"> • Check that the wiring configuration and the setting [Inside Delta] are not configured for in-line connection. • If [Inside Delta] setting is used, check the mains input.
 Clearing the Error Code	This detected error requires a power reset of the device after its cause has been removed.



[In Delta Wiring Error] DWF

Inside Delta wiring error

 Probable Cause	Incorrect inside-delta wiring detected by [In Delta Diag Status] DLTS .
 Remedy	Refer to <i>Connection Inside the Delta Of The Motor</i> , page 156 to perform the actions described by [In Delta Diag Status] DLTS .
 Clearing the Error Code	This detected error can be cleared manually with the [Fault Reset Assign] parameter after its cause has been removed.



[Ctrl Memory Error] EEF1

Control memory error

	Probable Cause	An error of the internal memory of the control block has been detected.
	Remedy	<ul style="list-style-type: none"> • Verify the environment (electromagnetic compatibility). • Do a power cycle. • Return to factory settings. • Contact your local Schneider Electric representative.
	Clearing the Error Code	This detected error requires a power reset of the device after its cause has been removed.



[Pwr Memory Error] EEF2

Power memory error

	Probable Cause	An error of the internal memory of the power board has been detected.
	Remedy	<ul style="list-style-type: none"> • Verify the environment (electromagnetic compatibility). • Do a power cycle. • Return to factory settings. • Contact your local Schneider Electric representative.
	Clearing the Error Code	This detected error requires a power reset of the device after its cause has been removed.



[External Error] EPF1

External detected error

	Probable Cause	<ul style="list-style-type: none"> • Error raised based on [Ext Error assign] configuration via [DI•] or [CD••]. • Duplicate or invalid IP address.
	Remedy	Remove the cause of the external error.
	Clearing the Error Code	This detected error can be cleared manually with the [Fault Reset Assign] parameter after its cause has been removed.



[Fieldbus Error] EPF2

External error detected by Fieldbus

 Probable Cause	Communication interruption with fieldbus module.
 Remedy	<ul style="list-style-type: none"> • Verify the communication bus is correctly wired. • Verify the fieldbus module is correctly plugged into the soft starter. • Refer to the appropriate fieldbus manual.
 Clearing the Error Code	This detected error can be cleared manually with the [Fault Reset Assign] parameter after its cause has been removed.



[Embd Eth Com Interrupt] ETHF

Embedded Ethernet communication interruption

 Probable Cause	Communication interruption on the Modbus TCP/Ethernet IP bus.
 Remedy	<ul style="list-style-type: none"> • Verify the communication settings on the devices. • Check for duplicate communication addresses. • Verify the environment (electromagnetic compatibility). • Verify the fieldbus wiring (continuity, cable type, grounding, and shielding) • Verify the time out. • Verify the Ethernet Client state. • Verify the Ethernet network load. • Refer to the Ethernet user manual. • Contact your local Schneider Electric representative. <p>NOTE: it is possible to check the status of ETHF through the communication with his register (ADL: 7136).</p>
 Clearing the Error Code	This detected error can be cleared with the [Auto Fault Reset] or manually with the [Fault Reset Assign] parameter after its cause has been removed.



[FDR 1 Error] FDR1

FDR Eth embedded error

 Probable Cause	<ul style="list-style-type: none"> • Communication interruption between the soft starter and the PLC during initialization. • Configuration file incompatible, empty or corrupted. • Soft starter rating not consistent with the configuration file.
 Remedy	<ul style="list-style-type: none"> • Verify the soft starter and PLC connection and communication. • Verify the communication workload. • Check that the configuration file is suitable for the installation. • Restart the transfer of configuration file from soft starter to PLC.
 Clearing the Error Code	This detected error can be cleared with the [Auto Fault Reset] or manually with the [Fault Reset Assign] parameter after its cause has been removed.



[Fan Feedback Error] F'FDF'

Fan feedback error

	Probable Cause	The [Fan Feedback Error] is trigger when the fan speed feedback is lower than the threshold of the minimum fan speed for at least 5s.
	Remedy	<ul style="list-style-type: none"> • Check the state of the fan. • Change the fan if the fan is in bad state.
	Clearing the Error Code	This detected error requires a power reset of the device after its cause has been removed.





[Mains Freq Error] F'RF'

Mains frequency out of tolerance

	Probable Cause	<ul style="list-style-type: none"> • Mains supply frequency out of the tolerance 50 / 60 Hz • Detected mains frequency at motor start different from the expected value set in [Mains Frequency] FRC
	Remedy	<ul style="list-style-type: none"> • Verify the mains supply frequency respect the tolerance 50...60 Hz, +/-5% (47,5...63 Hz) • Verify the expected mains supply frequency set in [Complete settings] CST → [Motor parameters] MPA → [Mains Frequency] FRC correspond to the frequency of your mains supply.
	Clearing the Error Code	This detected error can be cleared with the [Auto Fault Reset] or manually with the [Fault Reset Assign] parameter after its cause has been removed.



[FW Update Error] FWER

Firmware Update error

	Probable Cause	Firmware update function has detected an error.
	Remedy	<ol style="list-style-type: none"> 1.  In the menu [Device Management] DMT → [Firmware update] FWUP scroll to the parameter [Available Packages] APK and clear all the package . 2. Upload a new firmware 3. Proceed with a new firmware update. <p>For more information, refer to Soft starter firmware update, page 219.</p>
	Clearing the Error Code	This detected error is cleared as soon as its cause has been removed.



[No Power Comm Error] FWMC

No power communication error

 Probable Cause	<ul style="list-style-type: none"> No communication with power part while A1/A2 supply is present. Power firmware is invalid or a hardware failure has occurred
 Remedy	<ul style="list-style-type: none"> Try to restore power firmware If the LEDs Warning/Error and COM are red and yellow, perform a power reset. If the problem persists, contact your local Schneider Electric representative Refer to Soft starter firmware update, page 219.
 Clearing the Error Code	<p>This detected error is cleared as soon as its cause has been removed.</p>



[Fware Pairing Err] FWPF

Firmware pairing error

 Probable Cause	<p>Current firmware configuration is inconsistent.</p>
 Remedy	<ul style="list-style-type: none"> Restart the product Perform a firmware pairing Update the complete firmware of the device. Refer to Soft starter firmware update, page 219. If the problem persists, contact your local Schneider Electric representative.
 Clearing the Error Code	<p>This detected error is cleared as soon as its cause has been removed.</p>

[Boards Compat] HCF

Boards compatibility

 Probable Cause	<p>The [Pairing password] parameter has been enabled and one of the following parameters are not consistent:</p> <ul style="list-style-type: none"> Type of fieldbus modules. Firmware versions of the complete product. Serial numbers.
 Remedy	<ul style="list-style-type: none"> Refit the original fieldbus module. Confirm the configuration by entering the [Pairing password] if the module was changed deliberately. Perform a firmware update of the complete product.
 Clearing the Error Code	<p>This detected error is cleared as soon as its cause has been removed.</p>

[HW Topo Error] HPF

Hardware topology error



Probable Cause

- Product's hardware topology has changed.
- Option module has been changed.



Remedy

- Check your hardware configuration.



Clearing the Error Code

This detected error is cleared as soon as its cause has been removed.

[Internal Link Error] ILF

Internal communication interruption with option module



Probable Cause

Communication interruption between option module and the soft starter.



Remedy

- Verify the environment (electromagnetic compatibility).
- Verify that the fieldbus module is well inserted in the soft starter.
- Replace the fieldbus module with an identical fieldbus module.
- Contact your local Schneider Electric representative.

NOTE: it is possible to check the status of **ILF** through the communication with his register (ADL: 7134).



Clearing the Error Code

This detected error requires a power reset of the device after its cause has been removed.

[Internal Error 1] INF1

Internal error 1 (Rating)



Probable Cause

The power board rating is not valid.



Remedy

Contact your local Schneider Electric representative.





Clearing the Error Code

This detected error requires a power reset of the device after its cause has been removed.



[Internal Error 3] INF3

Internal error 3 (Intern Comm)

 Probable Cause	Internal communication detected error
 Remedy	Contact your local Schneider Electric representative.
 Clearing the Error Code	This detected error requires a power reset of the device after its cause has been removed.



[Internal Error 4] INF4

Internal error 4 (Manufacturing)

 Probable Cause	Internal data inconsistent.
 Remedy	Contact your local Schneider Electric representative
 Clearing the Error Code	This detected error requires a power reset of the device after its cause has been removed.



[Safety CPU error] INF5

Safety CPU error

 Probable Cause	Low level safety CPU error.
 Remedy	Reset the device or contact your local Schneider Electric representative.
 Clearing the Error Code	This detected error requires a power reset of the device after its cause has been removed.



[Internal Error 6] INF6

Internal error 6 (Option)

	Probable Cause	The compatibility of the option module is monitored internally.
		If an unknown module is installed, the INF6 error is triggered.
		<ul style="list-style-type: none"> • The option module is not recognized by the device nor compatible with the device. • An old ethernet embedded version is used.
		<ul style="list-style-type: none"> • To identify the error code, convert from decimal (ex: 4111) to hexadecimal (ex: 100F) the code displayed on the display terminal in the parameter [Error Info (INF6)] INF6, read the last two characters on the right (ex: 0F) and refer to the following list: <ul style="list-style-type: none"> ◦ Value = 0x●●00: No error detected. ◦ Value = 0x●●01: No response of the fieldbus module. Unplug and plug back the fieldbus module. ◦ Value = 0x●●09, 0x●●0B, 0x●●11: Incompatible fieldbus module. For the list of compatible fieldbus modules, refer to the catalog and to the fieldbus manuals. ◦ Value = 0x●●0F: Option module software version not compatible. Update the fieldbus module firmware, refer to Option Modules Firmware update, page 222. • Verify the catalog number and compatibility of the option module. • Update the Firmware to have a minimum V1.2IE04 version (ATS490-Firmware). • If the displayed code is not listed above, contact your local Schneider Electric representative.
	Remedy	
	Clearing the Error Code	This detected error requires a power reset of the device after its cause has been removed.



[Internal Error 8] INF8

Internal error 8 (Switching Supply)

	Probable Cause	The internal power switching supply is not correct.
		<ul style="list-style-type: none"> • Check the supplies of the installation. • Contact your local Schneider Electric representative.
	Clearing the Error Code	This detected error requires a power reset of the device after its cause has been removed.



[Internal Error 11] INF11

Internal error 11 (Temperature)

		Internal temperature sensors are monitored for short circuit or open circuit.
		If a short circuit / open circuit is detected, the INF11 error is triggered.
	Probable Cause	The internal device thermal sensor is not operating correctly.
	Remedy	Contact your local Schneider Electric representative.
	Clearing the Error Code	This detected error can be cleared with the [Auto Fault Reset] or manually with the [Fault Reset Assign] parameter after its cause has been removed.



[Internal Error 14] INFE

Internal error 14 (CPU)

 Probable Cause	Internal microprocessor detected error.
 Remedy	<ul style="list-style-type: none"> • Verify that the error code can be cleared with a power reset. • Contact your local Schneider Electric representative.
 Clearing the Error Code	This detected error requires a power reset of the device after its cause has been removed.



[Internal Error 15] INF5

Internal error 15 (Flash)

 Probable Cause	Serial memory flash format error.
 Remedy	Contact your local Schneider Electric representative.
 Clearing the Error Code	This detected error requires a power reset of the device after its cause has been removed.



[Internal Error 21] INFL

Internal error 21 (RTC)

 Probable Cause	Internal Real Time Clock error. It could be a clock oscillator start error.
 Remedy	Contact your local Schneider Electric representative.
 Clearing the Error Code	This detected error requires a power reset of the device after its cause has been removed.



[Internal Error 22] INF6

Internal error 22 (Embedded Ethernet)

 Probable Cause	<ul style="list-style-type: none"> • An error on the embedded Ethernet adapter has been detected. • Unstability of external 24 Vdc supply.
 Remedy	<ul style="list-style-type: none"> • Verify the connection to the Ethernet port. • Verify the 24 Vdc stability. • Contact your local Schneider Electric representative.
 Clearing the Error Code	This detected error requires a power reset of the device after its cause has been removed.



[Internal Error 25] INF_P

Internal error 25 (Incompatibility CB & SW)

 Probable Cause	Incompatibility between control board hardware version and firmware version.
 Remedy	<ul style="list-style-type: none"> • Update the firmware package. • Contact your local Schneider Electric representative
 Clearing the Error Code	This detected error requires a power reset of the device after its cause has been removed.



[Internal Error 26] INF_Q

Internal error 26 (thyristor cmd loss)

 Probable Cause	Thyristor command error.
 Remedy	Contact your local Schneider Electric representative.
 Clearing the Error Code	This detected error requires a power reset of the device after its cause has been removed.



[Internal Error 35] INF_Z

Internal error 35 (Invalid firmware version)

 Probable Cause	Invalid firmware version.
 Remedy	<ul style="list-style-type: none"> • Update product firmware with an official version from EcoStruxure Automation Device Maintenance or SoMove. • Contact your local Schneider Electric representative.
 Clearing the Error Code	This detected error is cleared as soon as its cause has been removed.



[Anti Jam Error] JAM_F

Anti Jam detected error

 Probable Cause	The Anti-Jam monitoring function has exceeded the maximum number of sequences allowed in the time window.
 Remedy	<ul style="list-style-type: none"> • Search for a clogging substance in the impeller. • Verify the settings of the monitoring function.
 Clearing the Error Code	This detected error can be cleared with the [Auto Fault Reset] or manually with the [Fault Reset Assign] parameter after its cause has been removed.



[Input Contact. Closed] LCCF

input contactor closed

 Probable Cause	After a <i>Stop order</i> , the device is still supplied by mains even though [Mains V. time out] has elapsed.
 Remedy	<ul style="list-style-type: none"> • Check the contactor and its wiring. • Check the time out. • Check the Supply Mains/contactor/device connection.
 Clearing the Error Code	This detected error can be cleared with the [Auto Fault Reset] or manually with the [Fault Reset Assign] parameter after its cause has been removed.



[Input Contactor] LCF

input contactor

 Probable Cause	The soft starter power stage is not supplied even though: <ul style="list-style-type: none"> • [Mains V. time out] LCT time-out has elapsed. • The relay assigned to the contactor should be activated. • The line contactor should be closed.
 Remedy	<ul style="list-style-type: none"> • Verify the settings of the parameters in the menu [Complete settings] CST → [Mains contactor cmd] LLC. • Verify the line contactor is in working order and its wiring. • Verify the line contactor coil is wired to the soft starter output. • Verify the presence mains supply on the line contactor and on the soft starter power stage inputs.
 Clearing the Error Code	This detected error can be cleared with the [Auto Fault Reset] or manually with the [Fault Reset Assign] parameter after its cause has been removed.

[Mains Direction Error] MDDF

Mains Direction Error

 Probable Cause	No mains direction detected.
 Remedy	Check the mains supply connection: at the soft starter and at others protection devices (circuit breakers, fuses, contactors).
 Clearing the Error Code	This detected error can be cleared with the [Auto Fault Reset] or manually with the [Fault Reset Assign] parameter after its cause has been removed.

[Mains Nom. Volt. Error] NOVF

Mains nominal overvoltage

	Probable Cause	Mains input voltage is above the defined threshold [Overvoltage Thld] during the time [OV detection delay] .
	Remedy	Check the mains voltage.
	Clearing the Error Code	This detected error can be cleared with the [Auto Fault Reset] or manually with the [Fault Reset Assign] parameter after its cause has been removed.

[Overcurrent] OCF

Overcurrent

	Probable Cause	<ul style="list-style-type: none"> • Short circuit (motor side). • Parameter [Boost] BST is not correct (if used). • Load too high (Mechanical locking). • Internal current sensor malfunction • Soft starter thyristor malfunction <p>If the soft starter was in [Ready] RDY state, it can be a short circuit between soft starter thyristor and output to motor.</p> <p>In case of multiple [ByPass Overcurrent] BYF4 or [Overcurrent] OCF errors triggered, the internal bypass relays may be damaged, leading to relays being stuck.</p>
	Remedy	<ul style="list-style-type: none"> • Verify if a short circuit (motor side) appears. • Check [Boost] BST configuration (if used). • Verify the motor. • Verify the size of the motor / load. • Verify the state of the mechanism. • Contact your local Schneider Electric representative.
	Clearing the Error Code	This detected error requires a power reset of the device after its cause has been removed.



[Device Overheat] OHF

Device overheating

	Probable Cause	Normal temperature of the device exceeded.
	Remedy	<ul style="list-style-type: none"> • Verify the ambient temperature, the device ventilation and the motor load. Wait for the device to cool down before restarting. • An excessive load can overheat the soft starter. • An excessive amount of starting can overheat the soft starter. • If the error is triggered during the ramp-up, set a more gentle start in the menu [Simply start] SIM.
	Clearing the Error Code	This detected error can be cleared manually with the [Fault Reset Assign] parameter after its cause has been removed.



[Process Overload] OLC

Process overload

 Probable Cause	<ul style="list-style-type: none"> Excessive load. Triggered by excessive motor current.
 Remedy	<ul style="list-style-type: none"> Verify and remove the cause of the overload on your process Verify the parameters of the [Overload Threshold] LOC function.
 Clearing the Error Code	This detected error can be cleared with the [Auto Fault Reset] or manually with the [Fault Reset Assign] parameter after its cause has been removed.



[Motor Overload] OLF

Motor overload

 Probable Cause	This error is triggered when an excessive motor current has been detected.
 Remedy	<ul style="list-style-type: none"> Verify the motor load. Wait for the device to cool down before restarting. An excessive load can overheat the motor. An excessive amount of starting can overheat the motor. Verify [Motor Class] THP parameter is well configured.
 Clearing the Error Code	This detected error can be cleared manually with the [Fault Reset Assign] parameter after its cause has been removed.



[Output Phase Loss] OPF

Output Phase Loss error

 Probable Cause	<ul style="list-style-type: none"> One or more motor phases lost. Defective motor or incorrect motor wiring.
 Remedy	Check the motor wiring and connection. NOTE: [Phase Loss Status] can provide the status of this error.
 Clearing the Error Code	This detected error can be cleared with the [Auto Fault Reset] or manually with the [Fault Reset Assign] parameter after its cause has been removed.



[Supply Mains OverV] OSF

Supply mains overvoltage

 Probable Cause	Supply Mains voltage too high (+10% of the maximum product voltage range during 3s).
 Remedy	Verify the Mains voltage.
 Clearing the Error Code	This detected error can be cleared with the [Auto Fault Reset] or manually with the [Fault Reset Assign] parameter after its cause has been removed.



[Prog Load Error] PGLF

Program loading detected error

 Probable Cause	Verify that the error code can be cleared with a power reset.
 Remedy	Contact your local Schneider Electric representative.
 Clearing the Error Code	This detected error is cleared as soon as its cause has been removed.



[Prog Run Error] PGRF

Program running detected error

 Probable Cause	Verify that the error code can be cleared with a power reset.
 Remedy	Contact your local Schneider Electric representative.
 Clearing the Error Code	This detected error requires a power reset of the device after its cause has been removed.



[Input Phase Loss] PHF

Input phase loss

 Probable Cause	<ul style="list-style-type: none"> • Device incorrectly supplied or a tripped fused. • One mains input or more phases are unavailable.
 Remedy	<ul style="list-style-type: none"> • Verify the wiring from the mains to the device, including the tightening of the connections. • Verify the fuses and the power connection.
 Clearing the Error Code	This detected error can be cleared with the [Auto Fault Reset] or manually with the [Fault Reset Assign] parameter after its cause has been removed.



[Phase Inversion] PIF

Phase inversion

 Probable Cause	<ul style="list-style-type: none"> • A reverse contactor used malfunction. • Detected phase direction at motor start different from the expected direction set in [Phase Inversion Mon] <small>PHR</small> in the menu [Monitoring] <small>PROT</small>.
 Remedy	<ul style="list-style-type: none"> • Check the state, the sequence and the wiring of the reverse contactor used. • Verify the direction set in [Phase Inversion Mon] <small>PHR</small> in the menu [Monitoring] <small>PROT</small>. • Verify the direction of the mains wiring upstream the soft starter • Invert two mains phases upstream the soft starter.
 Clearing the Error Code	<p>This detected error can be cleared with the [Auto Fault Reset] or manually with the [Fault Reset Assign] parameter after its cause has been removed.</p>



[Safety Func Error] SAFE

Safety function detected error

 Probable Cause	<ul style="list-style-type: none"> • Internal hardware error. • Power stage short circuit on one channel • Internal microcontroller overtemperature
 Remedy	<p>Verify lack of short-circuit on power stage.</p>
 Clearing the Error Code	<p>This detected error requires a power reset of the device after its cause has been removed.</p>



[Ground Short Circuit] SCF3

Ground short circuit

 Probable Cause	<p>Significant ground leakage current at the device output.</p>
 Remedy	<p>Verify the cables connecting the soft starter to the motor and the motor insulation.</p>
 Clearing the Error Code	<p>This detected error requires a power reset of the device after its cause has been removed.</p>



[SCR Sync Error] SDF

SCR Command Synchronisation Error

 Probable Cause	Unbalance phase during acceleration and deceleration.
 Remedy	Verify the motor supply connection.
 Clearing the Error Code	This detected error can be cleared with the [Auto Fault Reset] or manually with the [Fault Reset Assign] parameter after its cause has been removed.



[Mdb Com Interrupt] SLF1

Modbus communication interruption

 Probable Cause	Communication interruption on the Modbus port.
 Remedy	<ul style="list-style-type: none"> • Verify the communication bus. • Verify the timeout. • Refer to the Modbus communication manual.
 Clearing the Error Code	This detected error can be cleared manually with the [Fault Reset Assign] parameter after its cause has been removed.



[PC Com Interrupt] SLF2

PC communication interruption

 Probable Cause	Communication interruption with the commissioning software.
 Remedy	<ul style="list-style-type: none"> • Verify the commissioning software connecting cable. • Verify the timeout.
 Clearing the Error Code	This detected error can be cleared with the [Auto Fault Reset] or manually with the [Fault Reset Assign] parameter after its cause has been removed.



[HMI Com Interruption] SLF3

HMI communication interruption

 Probable Cause	<p>Communication interruption with the Graphic display terminal.</p> <p>This error is triggered when the command value is given using the Graphic Display Terminal and if the communication is interrupted during more than 2 seconds.</p>
 Remedy	<ul style="list-style-type: none"> • Verify the Graphic display terminal connection. • Verify the timeout.
 Clearing the Error Code	This detected error can be cleared with the [Auto Fault Reset] or manually with the [Fault Reset Assign] parameter after its cause has been removed.



[Simu Mains Detected] SMPF

Mains detected in simulation mode

 Probable Cause	Mains supply detected by the soft starter in simulation mode.
 Remedy	Verify that the mains supply is not wired to the soft starter and that the simulation mode is activated at the same time.
 Clearing the Error Code	This detected error can be cleared manually with the [Fault Reset Assign] parameter after its cause has been removed.



[Security Files Corrupt] SPFC

Security files corrupt

 Probable Cause	Security file corrupted or missing.
 Remedy	<ul style="list-style-type: none"> Connect a display terminal to your device, if not already connected. The error code is displayed. Press OK and select a cybersecurity profile. Refer to <i>Go to product by setting cybersecurity policy (advanced, minimum)</i>, page 109
 Clearing the Error Code	This detected error is cleared as soon as its cause has been removed.



[Sec Policy Update Err] SPTF

Security policy update error

 Probable Cause	Security policy transfer error, invalid security configuration.
 Remedy	<ul style="list-style-type: none"> Check the security policy to transfer and transfer it again. Check the connection.
 Clearing the Error Code	This detected error is cleared as soon as its cause has been removed.



[AI1 Th Sensor Error] T1CF

Thermal sensor error on AI1

 Probable Cause	The thermal monitoring function has detected an error of the thermal sensor connected to the analog input AI1: <ul style="list-style-type: none"> Open circuit or short circuit
 Remedy	<ul style="list-style-type: none"> Verify the sensor and its wiring. Replace the sensor.
 Clearing the Error Code	This detected error can be cleared with the [Auto Fault Reset] or manually with the [Fault Reset Assign] parameter after its cause has been removed.



[AI1 Th Level Error] TH1F

AI1 thermal level error

	Probable Cause	The thermal sensor monitoring function has detected a high temperature on the thermal sensor connected to the analog input AI1.
	Remedy	<ul style="list-style-type: none"> • Search for a possible cause of overheating. • Verify the settings of the monitoring function.
	Clearing the Error Code	This detected error can be cleared with the [Auto Fault Reset] or manually with the [Fault Reset Assign] parameter after its cause has been removed.



[Device Overheat] TJF

Device overheating

	Probable Cause	The thermal junction monitoring function helps to prevent the thyristors from junction over temperature.
	Remedy	<ul style="list-style-type: none"> • Verify the size of the load/motor/device according to environment conditions. • Verify the device ventilation and the ambient temperature.
	Clearing the Error Code	This detected error can be cleared manually with the [Fault Reset Assign] parameter after its cause has been removed.



[Too Long Start Err] TLSF

Too long start error

	Probable Cause	[Too Long Start] TLS is elapsed before meeting end of start conditions.
	Remedy	<ul style="list-style-type: none"> • Search for a mechanical jam blocking the motor. • Search for a possible cause of motor overload. • Verify the start profile in the [Simply Start] SYS menu. • Verify the value set to [Too Long Start Err] TLSF.
	Clearing the Error Code	This detected error can be cleared manually with the [Fault Reset Assign] parameter after its cause has been removed.



[Proc Underload] ULF

Process underload

	Probable Cause	Load too low.
	Remedy	<ul style="list-style-type: none"> • Verify and remove the cause of the underload. • Verify the parameters of the [Process underload] ULD function.
	Clearing the Error Code	This detected error can be cleared with the [Auto Fault Reset] or manually with the [Fault Reset Assign] parameter after its cause has been removed.

[Supply Mains UnderV] U5F

Supply mains undervoltage

 Probable Cause	<ul style="list-style-type: none">• Incorrect supply mains voltage.• Important voltage dip
 Remedy	<ul style="list-style-type: none">• Verify the mains supply.• Verify the value set to [Mains Voltage] <small>ULN</small>.• Verify the parameters in the [Undervoltage] menu.
 Clearing the Error Code	This detected error can be cleared with the [Auto Fault Reset] or manually with the [Fault Reset Assign] parameter after its cause has been removed.

Maintenance

What's in This Part

Scheduled Servicing.....	316
Define a service message	321
Real Time Clock (RTC).....	322
Decommissioning.....	323
Additional Support.....	324

Scheduled Servicing

Servicing

DANGER

HAZARD OF ELECTRIC SHOCK, EXPLOSION OR ARC FLASH

Read and understand the instructions in **Product Related Information** chapter before performing any procedure in this chapter.

Failure to follow these instructions will result in death or serious injury.

The temperature of the products described in this manual may exceed 80 °C (176 °F) during operation.

WARNING

HOT SURFACES

- Ensure that any contact with hot surfaces is avoided.
- Do not allow flammable or heat-sensitive parts in the immediate vicinity of hot surfaces.
- Verify that the product has sufficiently cooled down before handling it.
- Verify that the heat dissipation is sufficient by performing a test run under maximum load conditions.

Failure to follow these instructions can result in death, serious injury, or equipment damage.

WARNING

INSUFFICIENT MAINTENANCE

Verify that the maintenance activities described below are performed at the specified intervals.

Failure to follow these instructions can result in death, serious injury, or equipment damage.

Adherence to the environmental conditions must be ensured during operation of the device. In addition, during maintenance, verify and, if appropriate, correct all factors that may have an impact on the environmental conditions.

To verify	Part concerned	Activity	Interval (1)
Overall condition	All parts such as housing, HMI, control block, connections, etc.	Perform a visual inspection	At least every year
Corrosion	Terminals, connectors, screws	Inspect and clean if required	
Dust	Terminals, fans, cabinet air inlets and air outlets, air filters of cabinet		
Cooling	Soft starter fans	Perform a visual inspection of operating fans	
		Replace the fans, see catalog and the instructions sheets on se.com	After 3 to 5 years, depending on the operating conditions.
Fastening	All screws for electrical and mechanical connections	Verify tightening torques	At least every year
Device clock	Display terminal	Verify the displayed time and correct if required (for more information, refer to Real Time Clock (RTC), page 322)	At least every year
CR2032 device battery	On top side of the soft starter control block	Perform a visual inspection of the battery level on the display terminal	At least every year
(1) Maximum maintenance intervals from the date of commissioning. Reduce the intervals between maintenance to adapt maintenance to the environmental conditions, the operating conditions of the soft starter, and to any other factor that may influence the operation and / or maintenance requirements of the soft starter.			

NOTE: The fan operation depends on the soft starter thermal state. The soft starter may be running but not the fan.

Fans may continue to run for a certain period of time even after power to the product has been disconnected.

▲ CAUTION
RUNNING FANS
Verify that fans have come to a complete standstill before handling them.
Failure to follow these instructions can result in injury or equipment damage.

Replace the battery

HMI label	Setting	Factory setting
[Battery Level] <small>EBAL</small>	[No Battery]...100%	–
<p>Battery level Access path: [Device Management] → [Date & Time]</p> <p>Gives embedded battery level (updated by steps of 25%):</p> <ul style="list-style-type: none"> • 0%: Embedded battery is extremely low. • 25%: Embedded battery is low. • 50%-75%: Embedded battery is correct. • 100%: Embedded battery is full. • [No Battery] : Embedded battery is flat, damaged or not present <p>NOTE: In case of battery is empty or not present:</p> <ul style="list-style-type: none"> • The device has not yet been powered off: the device runs normally, showing a warning inviting the user to change it. If the battery is replaced, time and date are lost. • The device has already been powered off once: the device runs normally; time and date are not valid. Warning for changing the battery is present. • Motor thermal monitoring: in case of powering off, the device considers the last saved thermal state. <p>NOTE: In case of A1/A2 or 24V not present, if the battery is replaced, time and date are lost. The user will have to set time and date at next power ON.</p> <p>NOTE: Logged data will not be time stamped if battery level reached 0%.</p>		

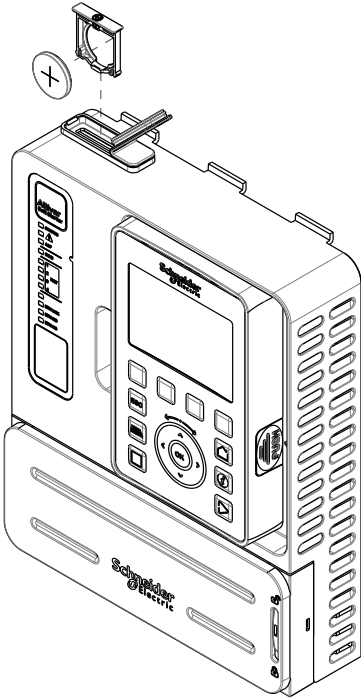
Step	Action
1	<p>Turn off your installation and remove the mains and A1/A2 supplies.</p> <p>Note:</p> <p>If the battery is empty :</p> <ul style="list-style-type: none"> • Removing the mains and A1/A2 supplies will result in date and time data loss. • The date and time need to be set at the next power up.
2	<p>Connect the +24 of the soft starter, page 46 to a +24V external source (if not already connected to an external source) and applied it to the product.</p> <p>Note:</p> <p>If the +24V is not applied or available:</p> <ul style="list-style-type: none"> • During the replacement of the battery, the date and time data will be lost. • The date and time need to be set at the next power up.
3	<p>Remove and replace the battery.</p> <p>Battery placement:</p> 
4	<p>After this operation, the +24V external source can be removed or turned off.</p>
5	<p>Connect to the mains and A1/A2 supplies and turn on your installation.</p>

Wear Parts

Order wear parts such as:

- Control block (VX4G4901)
- Fan sub assembly

Corresponding soft starter	Reference	
ATS490D88Y...ATS490C17Y	VZ3V4902	
ATS490C21Y...ATS490C41Y	1 fan kit necessary	VZ3V4903
ATS490C48Y...ATS490C66Y	3 fan kits necessary	
ATS490C79Y...ATS490M12Y	VZ3V4904	

NOTE: reset the counter after changing the fans, refer to Fan Counter Reset, page 278.

- IP20 kit assembly:

Corresponding soft starter	Reference
ATS490C14Y, ATS490C17Y	VW3G4701
ATS490C21Y...ATS490C41Y	VW3G4702
ATS490C48Y...ATS490C66Y	VW3G4703

Spare Parts

This product is repairable, please contact your Customer Care Center on:

www.se.com/CCC.

Define a service message

Under the **[Customization]** menu, use the **[Service Message]** menu to define up to 5 user-defined service messages.

This defined message is displayed in **[Diagnostics] → [Diag. data] → [Service Message]** submenu.

Real Time Clock (RTC)

Introduction

The soft starter has a real-time clock that provides the current date and time.

Clock Accuracy

The resolution of the real-time clock is 1 ms; The clock accuracy is affected by the operating temperature of the application:

Operating temperature	Maximum yearly drift at the first year of the product	Maximum yearly drift at the second year of the product	Maximum yearly drift at the third year of the product
25 °C (77 °F) stabilized	+/- 10.52 minutes	+/- 12.1 minutes	+/- 13.67 minutes
0...60 °C (32...140 °F)	+/- 36.8 minutes	+/- 38.38 minutes	+/- 39.95 minutes

Decommissioning

Uninstalling the Product

Observe the following procedure when uninstalling the device:

- If this device is going to be re-used in the future,
- Switch off all supply voltage. Verify that no voltage is present.

Refer to Product related information, page 9 for safety-related instructions.

- Remove all connection cables.
- Uninstall the product.

End of Life

The components of the product consist of different materials which can be recycled and which must be disposed of separately.

- Dispose of the packaging in compliance with all applicable regulations.
- Dispose of the product in compliance with all applicable regulations.

Refer to the **Environmental Data Program** for information and documents on environmental protection such as EoLI (End of Life Instruction).

You can download RoHS and REACH compliance declarations, Product Environmental Profiles (PEP) and End-of-Life instructions (EoLi).

Additional Support

Electronic product data sheet

Scan the QR code in front of the soft starter to get the product data sheet.

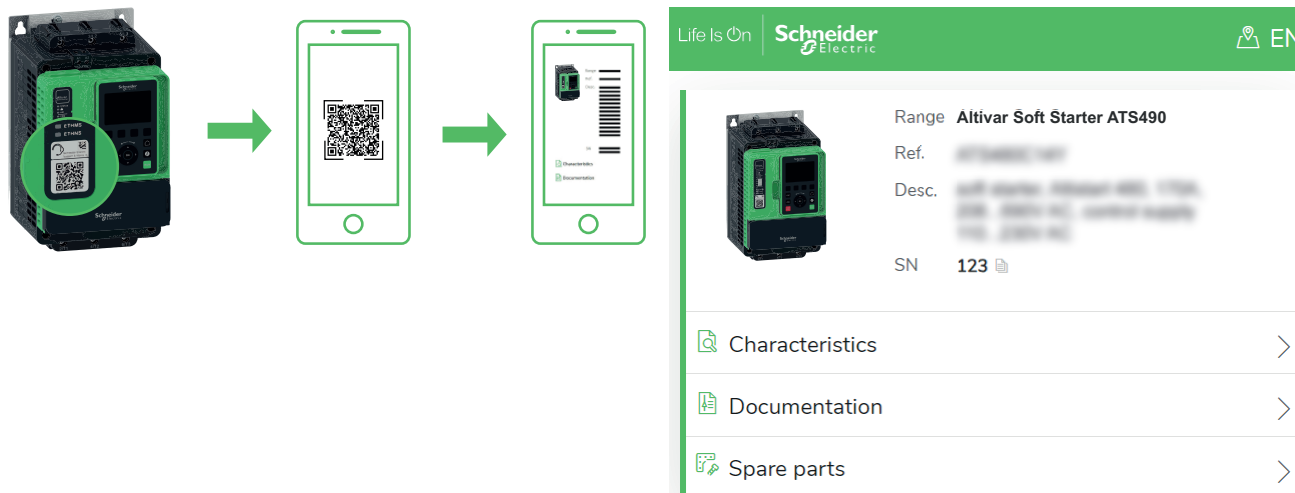

The diagram illustrates the process of scanning a QR code on a soft starter to access a mobile application interface. It shows a physical soft starter unit with a QR code on its front panel. An arrow points to a smartphone displaying the QR code, and another arrow points to a smartphone displaying the application interface. The application interface is a mobile app for Schneider Electric, showing the product range 'Altivar Soft Starter ATS490', a reference number, a description, and a serial number '123'. Below this information are three menu items: 'Characteristics', 'Documentation', and 'Spare parts', each with a right-pointing arrow.

Scanning the QR Code gives you access to :

- Product ID Card : Product range, Reference, short description and a Serial Number (Use the serial number to retrieve the product's manufacturing date).
About the Serial Number, refer to Manufacturing Date, page 325.
- The product characteristics : Main characteristics, environment, packing units, sustainability...
- Documentation : Technical Guidance at Glance (Presentation, Dimensions, Mounting, Wiring, Commissioning...) and Product Documentation (User guide, Instructions sheets, Certificates, How To videos...)
- Spare parts for your product

Manufacturing Date

Use the serial number on the nameplate of the soft starter to retrieve its manufacturing date.

The four digits before the 2 characters of the serial number provide respectively the year and the week of manufacture.

In the example below HL2422110100130 the manufacturing date is year 2024, week 22.



HL2422110100130

Customer Care Center

For additional support, you can contact our Customer Care Center on: www.se.com/CCC

Annex

What's in This Part

How to interpret and react to a NST state	327
How to interpret and react to a TBS state	328
How to determine which units are applicable for your soft starter?	329
Difference between Normal and Heavy duty	330
Soft Starter State.....	331
Perform a demonstration with the device	332
HMI Tree Navigation.....	337

How to interpret and react to a NST state

Root causes of NST state

The following table provides possible root causes of NST status. Several causes can occur at the same time.

NST state	How to move from NST
Command via fieldbus	Check the CMD value. This depends on the control profile used (STD / IO) and the channel used. Refer to the communication manuals for more information.
Run order already present	Check that the digital or virtual inputs are switched back to low level before trying a new command such as forward, reverse, preheating, anti-jam.
3 wire terminal	Check that the DI1 is at high level.
[Device Lock] LES	Check that the digital or virtual input assigned to [Device Lock] is at the right level.
HMI Stop Key	Check the HMI Stop key is not pressed.

NOTE: If a Stop command is applied via a channel different from the active command channel, the NST State is displayed as long as the RUN command from the active command channel is not removed.

How to interpret and react to a TBS state

The **[Wait for Restart]** TBS state is a delay before being able to restart the motor. It represents the longest of the following delays:

- **[Time Before Restart]**: configurable timer. Refer to Time Before Restart, page 138.
- **[Change Dir Delay]**: reverse by external contactor function has been used. Refer to Reverse by External Contactor , page 179.
- **[Mot Therm Estimation]**: delay to have the motor thermal estimation lower than a threshold. The remaining time linked to this delay can be monitored using **[Time Before Starting]**. Refer to Motor Thermal Protection Class, page 129.
- **[PumpCycle Monitor]**: maximum number of allowed starts **[PumpCycle MaxStarts]** during a defined time frame **[PumpCycle timeframe]** has been reached. Refer to Pumpcycle Monitoring, page 139.

The remaining time in **[Wait for Restart]** TBS state could be monitored via **[Time Before Starting]** MRT. Refer to Monitor other measurements, page 260.

How to determine which units are applicable for your soft starter?

The unit, which depends on the size of the product, is displayed for :

Current	Electrical Motor Active Power	Electrical Motor Reactive Power	Torque
<ul style="list-style-type: none"> For sizes smaller than ATS490C25Y, the unit is 0.1 A. For ATS490C25Y and up, the unit is 1 A. 	<ul style="list-style-type: none"> For sizes smaller than ATS490C25Y, the unit is 0.1 kW. For ATS490C25Y and up, the unit is 1 kW. 	<ul style="list-style-type: none"> For sizes smaller than ATS490C25Y, the unit is 0.1 kVAr. For ATS490C25Y and up, the unit is 1 kVAr. 	<ul style="list-style-type: none"> For sizes smaller than ATS490C25Y, the unit is 0.1 Nm. For ATS490C25Y and up, the unit is 1 Nm.

Difference between Normal and Heavy duty

Depending on the type of machine, the applications are categorized as normal duty or heavy duty based on the starting characteristics, which are given as examples only in the table below.

Type of machine	Application	Functions performed by the Altivar Soft Starter ATS490	Starting current (% In)	Starting time (s)
Fan	Normal duty Heavy duty if > 30 s	Detection of overloads caused by clogging or underloads (motor/fan transmission broken) Braking torque on stopping	300	10 to 40
Centrifugal pump	Normal duty	Deceleration (reduction in pressure surges) Detection of underload or reversal of phase rotation direction Automatic activation of anti-jam function on settable overload threshold	300	5 to 15
Piston pump	Normal duty	Control of pump priming and direction of rotation	350	5 to 10
Borehole pump	Normal duty	Starting of pump based on two torque limits, the first one higher than the second to quickly reach a minimum flow and help ensure the proper lubrication of the bearings	300	up to 2
Cold compressor	Normal duty	Monitoring, even for special motors	300	5 to 10
Screw compressor	Normal duty	Detection of reversal of phase rotation direction Contact for automatic draining on stopping	300	3 to 20
Centrifugal compressor	Normal duty Heavy duty if > 30 s	Detection of reversal of phase rotation direction Contact for automatic draining on stopping	350	10 to 40
Piston compressor	Normal duty	Detection of reversal of phase rotation direction Contact for automatic draining on stopping	350	5 to 10
Conveyor, transporter	Normal duty	Monitoring of overloads for incident detection or underloads for break detection JOG function in mechanical setting steps	300	3 to 10
Lifting screw	Normal duty	Monitoring of overloads for hard spot detection or underloads for break detection	300	3 to 10
Drag lift	Normal duty	Monitoring of overloads for jamming detection or underloads for break detection	400	2 to 10
Lift	Normal duty	Monitoring of overloads for jamming detection or underloads for break detection Constant starting with variable load JOG function in mechanical setting steps	350	5 to 10
Circular saw, band saw	Normal duty Heavy duty if > 30 s	Braking for fast stop	300	10 to 60
Pulper, butchery cutter	Heavy duty	Torque control on starting	400	3 to 10
Agitator	Normal duty	The current display indicates the density of the material	350	5 to 20
Mixer	Normal duty	The current display indicates the density of the material	350	5 to 10
Grinder	Heavy duty	Braking to limit vibrations during stopping, monitoring of overloads for jamming detection	450	5 to 60
Crusher	Heavy duty	Braking to limit vibrations during stopping, monitoring of overloads for jamming detection	400	10 to 40
Refiner	Normal duty	Torque control on starting and stopping	300	5 to 30
Press	Heavy duty	Braking to increase the number of cycles	400	20 to 60

Soft Starter State

List of possible soft starter states, visible on the Graphic Display Terminal.

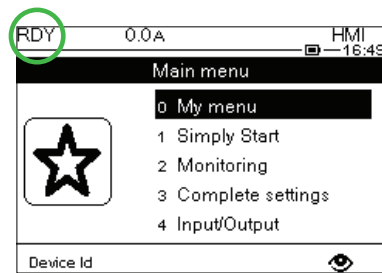

State	Condition
Displayed error label	Detected error. The soft starter is in operating state Fault.
[Ready] RDY	No <i>RUN</i> command and mains supplied.
[No Mains Voltage] NLP	Mains not supplied.
[Ctrl Supply Loss] CLA	The warning [Ctrl Supply Loss] triggers when control supply is lost, the soft starter is not running and [Control Supply Loss] is set to [Warning] .
[Running] RUN	Soft starter in operating state.
[Bypassed] BYP	Bypass active.
[Accelerating] ACC	Soft starter in acceleration phase.
[Decelerating] DEC	Soft starter in deceleration phase.
[Wait for Restart] TBS	Starting time delay not elapsed.
[Freewheel] NST	Soft starter forced to freewheel stop.
[Braking In Prog] BRL	Soft starter in braking phase.
[Current Limitation] CLI	Soft starter in current limitation.
[Motor Preheating] HEA	Motor preheating, correspond to one of the following step of the preheating sequence: <ul style="list-style-type: none"> Preheating order applied but [Time Before Preheat] not elapsed, no preheating current injected yet. Preheating order applied and [Time Before Preheat] elapsed, preheating current is injected.
[Small Motor Test] SST	Small motor test in progress.
[Firmware Update] FWUP	Firmware update in progress.
[Demo Mode] DEMO	Demonstration mode active.
[Simu Mode] SIMU	Simulation mode active.
[JOG mode] JOG	JOG mode active.
[Anti-Jam Mode] AJAM	Anti-Jam mode active.
[STO active] STO	Safe Torque Off active.
[2nd Current Limit] CLI2	2nd current limitation active.

When current limitation is active, the displayed value flashes.

It is still possible to modify the parameters if the soft starter detects an error.

Perform a demonstration with the device

Enter in the Demo Mode

In the **[Initial Setup]** menu, scroll to **[Demo Mode]** and press **OK**.

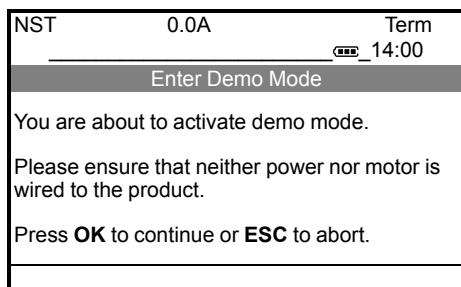

During the demo mode, the device goes through the same steps as if it had been integrated into a real application. Depending on the wiring and the configuration of the device, this may result in immediate and unanticipated operation.

⚠ WARNING
UNANTICIPATED EQUIPMENT OPERATION
<ul style="list-style-type: none"> Do not enable the demo mode when the product is wired on the application. Verify that the activation of the digital outputs and/or the relays cannot result in unsafe conditions.
Failure to follow these instructions can result in death, serious injury, or equipment damage.

Press **OK** again to confirm (or **ESC** to go back to the **[Initial Setup]** menu.)

Result: The main menu is displayed and can be navigated through.

- The **[Demo Mode]** will stay **active** after a power Off and a message will be displayed on every power On.

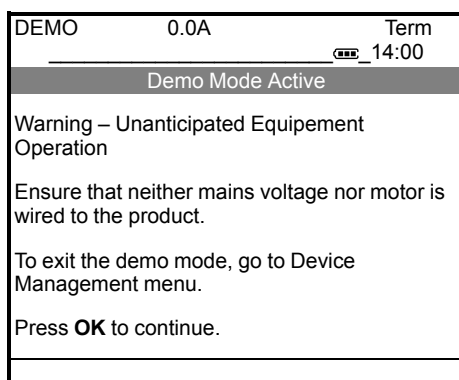

- When **[Demo Mode]** is active, **[Simulation mode]**  menu is visible.
- The **[Simu Mains Detected]** will trigger if the mains are supplied on the device in demonstration mode.

Leave the Demo Mode

To leave the **[Demo Mode]**, scroll to **[Exit Demo Mode]** in the menu **[Device Management]**.

Result: The modifications done in **[Demo Mode]** are erased and **[Initial Setup]** is displayed.

Perform a simulation with the device

The purpose of this function is to validate an automation architecture by simulating the **system architecture**.

The Simulation mode is an average simulation of the real motor behavior, based on the fundamental frequency. The behavior or amplitude of the signals can be different from reality.

The function allows the user to:

- Set up communication
- Configure the soft starter
- Simulate a motor
- Configure the mains, with a warning triggered in case of inconsistency with the motor data
- Proceed a Start and Stop
- Select a type of load
- Create an event causing a change of state of the soft starter, such as changing direction, loss synchronization, loss of phase and loss of mains.

During the simulation mode, the device goes through the same steps as if it had been integrated into a real application. Depending on the wiring and the configuration of the device, this may result in immediate and unanticipated operation.

▲ WARNING
UNANTICIPATED EQUIPMENT OPERATION
<ul style="list-style-type: none">• Do not enable the simulation mode when the product is wired on the application.• Verify that the activation of the digital outputs and/or the relays cannot result in unsafe conditions.
Failure to follow these instructions can result in death, serious injury, or equipment damage.

Enter the Simulation Mode

- In the **[Device Management]** menu, scroll to **[Enter Simulation]** and press **OK**.

Result: The Simulation mode is activated and can be configured in the **[Simulation mode]** menu.

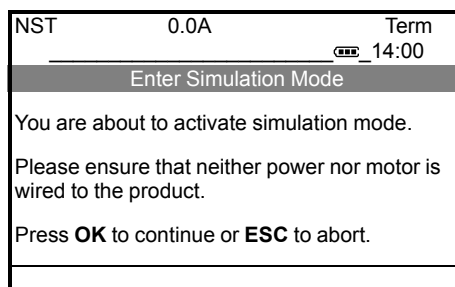

- In the **[Simulation mode]** menu, the parameter **[Simu Mode Assign]** can be set to:
 - **[Standard]** : Simulation with motor and mains parameters pairing.
 - **[Custom]** : Choice between simulation with motor parameters pairing only, or motor and mains parameters pairing.

Parameters description

Access path: [Device Management] → [Simulation mode]

HMI label	Setting	Factory setting
[Simu Mode Assign] <i>SIMM</i>	–	[No] <i>NO</i>
<p>Simulation mode assignment</p> <ul style="list-style-type: none"> • [Standard] <i>STD</i> : Standard simulation mode active. • [Custom] <i>CUST</i> : Custom simulation mode active. 		
[Simu Motor Pairing] <i>SIMP</i>	–	[Motor & Mains] <i>MMSP</i>
<p>Simulated motor paired on product rating</p> <ul style="list-style-type: none"> • [Motor & Mains] <i>MMSP</i> : Activating of pairing for motor and mains. • [Motor] <i>MOSP</i> : Activating of pairing for motor only. <p>This parameter can be accessed only if [Simu Mode Assign] is set to [Custom].</p>		
[Simu Static Load] <i>SIMS</i>	0...200%	0
<p>Simulated static load</p> <p>Static load torque adjustment.</p> <p>This parameter can be accessed only if [Simu Mode Assign] is set to [Custom].</p>		
[Simu Linear Load] <i>SIML</i>	0...200%	0
<p>Simulated linear load</p> <p>Linear load torque adjustment.</p> <p>This parameter can be accessed only if [Simu Mode Assign] is set to [Custom].</p>		
[Simu Quadratic Load] <i>SIMQ</i>	0...200%	100
<p>Simulated quadratic load</p> <p>Quadratic load torque adjustment.</p>		
[Simulated Action] <i>SIMC</i>	–	–
<p>Simulated action</p> <p>This parameter allows to simulate an external perturbation or action via a control word.</p> <ul style="list-style-type: none"> • Bit 0 : Simulated network direction (0=direct) • Bit 7: Input phase 1 loss • Bit 8: Input phase 2 loss • Bit 9: Input phase 3 loss • Bit 10: Output phase 1 loss • Bit 11: Output phase 2 loss • Bit 12: Output phase 3 loss 		

Mains settings simulation

This menu can only be accessed if **[Simu Mode Assign]** is set to **[Custom]** and **[Simu Motor Pairing]** is set to **[Motor]**.

Access path: **[Device Management]** → **[Simulation mode]** → **[Simu Mains Settings]**

HMI label	Setting	Factory setting
[Simu Mains Volt] <i>SLPV</i>	170 V ... 760 V	400 V
<i>Mains voltage in simulation mode</i> Voltage of the mains in simulation mode.		
[Simu Mains Freq] <i>SLPF</i>	30.0...80.0 Hz	50.0 Hz
<i>Mains frequency in simulation mode</i> Frequency of the mains in simulation mode.		

Leave the Simulation Mode

To leave the **[Simulation mode]**, scroll to **[Exit Simulation]** in the menu **[Device Management]**.

HMI Tree Navigation

[Simply Start]

Menu	Name	Code	Description	Settings	Factory Default Value	Chapter Reference
1.	[Simply start]	SIM	Minimum parameters to start and stop a motor in torque control.	–		Simply Start, page 119
1.	[2/3-Wire Control]	TCC	<i>2/3-wire control</i>	–	[2-Wire Control]	Set Type of Wire Control, page 121
2.	[2-wire type]	TCT	<i>Type of 2-wire control</i>	–	[Transition]	
3.	[Motor Nom Current]	IN	<i>Nominal current</i>	–	Corresponding to the usual value of a 4-pole 400 V standardized induction motor and [Inside Delta] is set to [No] (soft starter connected in-line).	Set The Currents, page 122
4.	[Current Limit]	ILT	<i>Motor limiting current</i>	150...700%	400% of [Motor Nom Current]	
5.	[Acceleration]	ACC	<i>Acceleration ramp time</i>	1...180 s	15 s	Set Start Profile, page 124
6.	[Init Starting Torque]	TQ0	<i>Initial starting torque</i>	0...100 %	20%	
7.	[Type of stop]	STT	<i>Type of stop</i>	–	[Freewheel]	Set Stop Profile, page 125
8.	[Deceleration]	DEC	<i>Deceleration ramp time</i>	1...180 s	15 s	
9.	[End Of Deceleration]	EDC	<i>End of controlled deceleration threshold</i>	0...100% of estimated torque when a Stop order is applied	20%	
1-0.	[Braking Level]	BRC	<i>Dynamic braking level</i>	0...100 %	50	
1-1.	[DC Braking Time]	EBA	<i>DC continuous braking time</i>	20...100 %	20	
2.	[Modified parameters]	LMD	List of ten last edited parameters.	–	–	-
3	[Jog]	JOG	This function allows to move an engine manually until a given position, at a speed lower than the normal speed.	–	–	Motor Jog, page 182

[Monitoring]

Menu	Name	Code	Description	Settings	Factory Default Value	Chapter Reference
1.	[Motor Class]	THP	Motor thermal protection class	–	[Class 10E]	Motor Thermal Protection Class, page 129
2.	[Process underload]	ULD	This menu provides the parameters to configure the motor underload detection and management.	–	–	Process Underload, page 135
1.	[Underload Activation]	UDLA	Underload activation	[Yes] or [No]	[No]	
2.	[Unld Detect Delay]	ULT	Motor underload time	0...60 s	60 s	
3.	[Underload Threshold]	LUL	Underload threshold	20...100% of Tn	60%	
4.	[Underload ErrorResp]	UDL	Response to underload error	-	[No]	
5.	[Underload T.B.Rest.]	FTU	Unld time Before Restart	0...6 min	0	
3.	[Too Long Start]	TLS	Excessive starting time	10...999 seconds or [No]	[No]	Too long start, page 136
4.	[Long Start Error Resp]	STB	Response to a too long start error	-	[Freewheel]	
5.	[Process overload]	OLD	This menu provides the parameters to configure the motor overload detection and management.	–	–	Process Overload, page 133
1.	[Overload Activation]	ODLA	Overload activation	[Yes] or [No]	[No]	
2.	[Ovld Detection Delay]	TOL	Overload detection delay	0...100 s	10 s	
3.	[Overload Threshold]	LOC	Current overload threshold	50...300% of [Motor Nom Current]	80 %	
4.	[Overload ErrorResp]	ODL	Response to overload error	–	[No]	
5.	[Overload T.B.Rest.]	FTO	Ovld time Before Restart	0...6 min	0	
6.	[Phase Inversion Mon]	PHR	Phase Inversion Monitoring	–	[No]	Phase Inversion, page 137
7.	[Time Before Restart]	TBS	Time before motor restart	0...999 s	2 s	Time before restart, page 138
8.	[Mot Therm Estimation]	THAC	Motor thermal Estimation Activation	[Yes] or [No]	[No]	Motor Thermal Estimation, page 138
9.	[Pumpcycle monitoring]	CSP	This menu provides the parameters to monitor application (pump), motor and/or soft starter from overheating.	–	–	Pumpcycle Monitoring, page 139
1.	[PumpCycle Monitor]	PCPM	Pump cycle monitoring mode	[No] or [Mode 1] or [Mode 2]	[No]	
2.	[PumpCycle MaxStarts]	PCPN	Pump cycle maximum allowed starts	1...99	6	
3.	[PumpCycle timeframe]	PCPT	Pump cycle timeframe	1...3600 min	60	
11.	[Motor phase loss]	PHLM	This menu provides the parameters to define and	–	–	Phase loss, page 140

Menu	Name	Code	Description	Settings	Factory Default Value	Chapter Reference
			monitor a motor loss of phase.			
	1. [Phase Loss Monit]	PHP	Phase loss monitoring	[Yes] or [No]	[Yes]	
	2. [Phase Loss Cur Thd]	PHL	Phase loss current threshold	5...10% of soft starter current rating	10%	
12.	[Overvoltage]	OVPR	This menu provides the parameters for defining the behavior in the event of overvoltage.	–	–	Overvoltage and Undervoltage, page 141
	1. [Overvoltage Thld]	OSD	Overvoltage threshold	110...115% of Mains voltage ULN	110%	
	2. [OV detection delay]	OSFD	Overvoltage detection delay	1...10 s	2 s	
	3. [Voltage Error Resp]	MVFB	Response to an under/overvoltage error	–	[No]	
13.	[Undervoltage]	UVPR	This menu provides the parameters for defining the behavior in the event of overvoltage.	–	–	Unbalanced Voltage and Unbalanced Current, page 143
	1. [Undervoltage Thld]	USD	Undervoltage threshold	50...90% of Mains voltage ULN	85%	
	2. [UV Detection Delay]	USFD	Undervoltage detection delay	1...60 s	5 s	
	3. [Voltage Error Resp]	MVFB	Response to an under/overvoltage error	–	[No]	
14.	[Unbalance]	UNPR	This menu provides the parameters for defining the behavior in the event of unbalanced voltage and current.	–	–	Mains Frequency, page 143
	1. [Volt Unbalance Thld]	MVUT	Mains unbalance threshold	5...10%	5%	
	2. [Curr Unbalance Thld]	CURT	Current unbalance alarm threshold	5...60% or [No]	[No]	
	3. [Curr Unbalance Delay]	CURD	Current unbalance alarm Delay	1...60s	10s	
15.	[Mains Frequency]	FRPR	This menu provides the parameters for defining the mains frequency.	–	–	Motor External Thermal Sensor, page 145
	1. [Frequency Diag]	FRDA	Line Frequency Diagnostic activation	[At Run Order] or [Freq Diag Activation]	[At Run Order]	
	2. [Mains Frequency]	FRC	Mains frequency	<ul style="list-style-type: none"> • [Auto] • [50Hz] • [60Hz] • [Custom] 	[Auto]	
	3. [Freq Error Resp]	FRFB	Response to a line frequency error	<ul style="list-style-type: none"> • [Ignore] • [Freewheel Stop] • [Deceleration] • [Braking] 	[Freewheel Stop]	
	4. [Low Frequency]	FRTL	Frequency Range Low value	40...60 Hz	47 Hz	
	5. [High Frequency]	FRTH	Frequency Range High value	50...75 Hz	63 Hz	
16.	[Thermal monitoring]	TPP	This menu provides the parameters for defining the thermal monitoring.	–	–	

Menu	Name	Code	Description	Settings	Factory Default Value	Chapter Reference
1.	[AI1 Th Monitoring]	TH1S	Activation of the thermal monitoring on AI1	<ul style="list-style-type: none"> [Not Configured] [AI1] 	[Not Configured]	
2.	[AI1 Type]	AI1T	Configuration of AI1	<ul style="list-style-type: none"> [Not Configured] [PTC] [KTY] [PT1000] [PT100] [PT1000 in 3 wires] [PT100 in 3 wires] 	[Not Configured]	
3.	[AI1 filter]	AI1F	AI1 filter	0...10 s	0 s	
4.	[AI1 Th Error Resp]	TH1B	Response to thermal error for AI1	<ul style="list-style-type: none"> [Ignore] [Freewheel Stop] [Configured Stop] [Deceleration] [Braking] 	[Freewheel Stop]	
5.	[Temperature unit]	SUTP	Application Temperature Unit (used as default)	[0.1°C] or [0.1°F]	[0.1°C]	
6.	[AI1 Th Error Level]	TH1F	Thermal error level for AI1	Range: -15.0...200.0°C	110.0°C	
7.	[AI1 Th Warn Level]	TH1A	Thermal warning level for AI1	Range: -15.0...200.0°C	90.0°C	
8.	[AI1 Th Value]	TH1V	AI1 thermal value	Range: -15.0...200.0°C	-	
17.	[Gamma Sync Error]	TSC	Gamma synchro error	0...10 or [No]	8	Gamma sync, page 148
18.	[Mot Th State Reset]	RTHR	Reset motor thermal state	[Yes] or [No]	[No]	Motor External Thermal Sensor, page 145

[Complete settings]

Menu	Name	Code	Description	Settings	Factory Default Value	Chapter Reference
1.	[Motor parameters]	MPA	—	—	—	
1.	[Motor Nom Current]	IN	Nominal current	—	Corresponding to the usual value of a 4-pole 400 V standardized induction motor and [Inside Delta] is set to [No] (soft starter connected in-line).	Set Motor Nameplate Parameters, page 151
2.	[Nom Motor Voltage]	UNS	Nominal motor voltage	0...710V	0 V	
3.	[Nominal Motor Freq]	FRS	Nominal motor frequency	0...75.0 Hz	0 Hz	
4.	[Nominal Motor Spd]	NSP	Nominal motor speed	0...4500 rpm	0 rpm	
5.	[Motor Power unit]	MPUT	Motor Power unit type	[Kilo Watts] or [Horse Power]	[Kilo Watts]	

Menu	Name	Code	Description	Settings	Factory Default Value	Chapter Reference
1.	6. [Nominal Motor Power]	NPR	Nominal motor power	0...300000	0	Set Second Current Limitation, page 153
	7. [Current Limit]	ILT	Motor limiting current	150...700%	400% of [Motor Nom Current]	
	8. [Ext Curr Lim Assign]	ILXA	External current limitation activation			
	9. [Ext Current Limit]	ILX	External current limitation level (% of Motor Nominal Current)	150...700%	400% of [Motor Nom Current]	Set The Mains Voltage, page 150
	10. [Mains Voltage]	ULN	Mains voltage	170...760 V	400 V	
2.	[Mains contactor cmd]	LLC		–	–	Mains contactor command, page 155
	1. [Mains Contactor]	LLC	Mains contactor control	[Not Assigned] , [R1] , [R2] or [R3]	[Not Assigned]	
	2. [Device Lock]	LES	Device lock assignment	–	[Not Assigned]	
	3. [Mains V. time out]	LCT	Mains V. time out	1...999 s	5 s	
3.	[Reverse by contactor]	REV	This menu provides the parameters to manage a line contactor upstream the soft starter.	–	–	Reverse by External Contactor , page 179
	1. [Cmd Relay Selection]	RCC	Reverse contactor command relay selection	[Not Assigned], [R2] or [R3]	[Not Assigned]	
	2. [Change Dir Delay]	RCD	Change Direction Delay	1...10 s	2 s	
3.	[Reverse Assign]	RRS	Reverse assignment	<ul style="list-style-type: none"> • [Not Assigned] • [DI•] • [CD••] 	[Not Assigned]	
4.	[Motor wiring]	MWMT	This function enables the soft starter connection in the motor delta winding.	–	–	Inside the Delta of the Motor, page 156
	1. [Inside Delta]	DLT	Inside Delta wiring	<ul style="list-style-type: none"> • [No] • [Yes] 	[No]	
	2. [In Delta Diag]	DLTL	Inside Delta diagnostics	<ul style="list-style-type: none"> • [No] • [Yes] 	[No]	
	3. [In Delta Diag Status]	DLTS	Inside Delta diagnostics status	<ul style="list-style-type: none"> • [Not Done] • [Passed] • [Pending] • [Invert L2 & L3] • [Invert L1 & L2] • [Invert L1 & L3] • [Change 123 to 312] • [Change 123 to 231] • [Bad Motor Wiring] • [Unknown Error] • [Input Phase Loss] 	–	
	4. [Small Motor Test]	SST	Small motor test	–	[No]	Small Motor Test, page 160
5.	[Preheating]	PRF	By applying a current inside the motor windings, the preheating function can be used before starting the motor to: <ul style="list-style-type: none"> • Unfreeze the motor. 	–	–	Motor Preheating, page 168

Menu	Name	Code	Description	Settings	Factory Default Value	Chapter Reference
			<ul style="list-style-type: none"> Help to prevent temperature deviations and condensation. Start the motor at the same temperature to limit the variations between cold and warm state. 			
1.	[Preheating Assign]	PRHA	Preheating assignment	<ul style="list-style-type: none"> [Not Assigned] [Yes] [Preheat Temp Range] [DI•] [CD••] 	[Not Assigned]	
2.	[Preheat Level]	IPR	Preheating level	5...70% (in % of the nominal motor current)	5%	
3.	[Time Before Preheat]	TPR	Time before preheat	0...999 min	5 min	
4.	[Temp Low]	TPLO	Preheating temperature low limit	-15...200°C / 5...392°F	0.0°C / 32.0°F	
5.	[Temp High]	TPHI	Preheating temperature high limit	-15...200°C / 5...392°F	0.0°C / 32.0°F	
6.	[Start & Stop]	SSP	This menu provides the parameters to manage Start and Stop.	–	–	
1.	[Control Mode]	CLP	Control mode	[Torque Control] or [Voltage Control]	[Torque Control]	
2.	[Acceleration]	ACC	Acceleration ramp time	1...180 s	15 s	
3.	[Init Starting Torque]	TQ0	Initial starting torque	0...100% of nominal torque	20%	
4.	[Init Starting Voltage]	V0	Initial starting voltage	25%...49% of [Mains Voltage]	49%	
5.	[Boost Assign]	BSTE	Boost assignment	–	[Not Assigned]	
6.	[Boost]	BST	Voltage boost level	50...100% of the nominal motor voltage or [No]	[No]	
7.	[Type of stop]	STT	Type of stop	–	[Freewheel Stop]	Start and Stop, page 164
8.	[Deceleration]	DEC	Deceleration ramp time	1...180 s	15 s	
9.	[Deceleration Gain]	TIG	Torque control deceleration gain	10...50 %	40%	
10.	[End Of Deceleration]	EDC	End of controlled deceleration threshold	0...100% of estimated torque when a Stop order is applied	20%	
11.	[Freewheel level dec]	EDCV	Threshold for changing to freewheel stop in voltage control	25...100 %	30%	
12.	[Braking Level]	BRC	Dynamic braking level	25...100 %	50%	
13.	[DC Braking Time]	EBA	DC continuous braking time	20...100 %	20%	
14.	[Torque Limit]	TLI	Torque limit	10...200% or [No]	[No]	
15.	[Stator Loss Comp]	LSC	Stator loss compensation	0...90 %	25%	
7.	[2nd Mot Parameters]	ST2	This menu can be used to configure a second set of parameters on the same soft starter.	–	–	Second Set of Motor Parameters, page 190
1.	[2nd Mot Assign]	LIS	Second motor selection assignment	<ul style="list-style-type: none"> [Not Assigned] [DI•] [CD••] 	[Not Assigned]	

Menu	Name	Code	Description	Settings	Factory Default Value	Chapter Reference
2.	[2nd Motor Usage]	LISC	<i>2nd motor usage selection</i>	<ul style="list-style-type: none"> [2 Applications] [2-Speed Motor] 	[2-Speed Motor]	
3.	[Nom Speed Motor 2]	NMS2	<i>Nominal speed Motor 2</i>	[Same As Mains]; 33...4500 rpm	[Same As Mains]	
4.	[Nom Power Motor 2]	NPM2	<i>Nominal power Motor 2</i>	70...1840 In (kW or HP)	[Same As Mains]	
5.	[Nom Current Motor 2]	INM2	<i>Motor 2 nominal current</i>	–	Corresponding to the usual value of a 4-pole 400 V standardized induction motor and [Inside Delta] is set to [No] (soft starter connected in-line).	
6.	[Current Limit Motor 2]	ILM2	<i>Motor 2 current limit</i>	150...500%	400% of [Motor Nom Current]	
7.	[Acceleration Motor 2]	ACM2	<i>Motor 2 acceleration time</i>	1...60 s	15 s	
8.	[Init Start Torque Mot 2]	TQM2	<i>Motor 2 initial starting torque</i>	0...100% of nominal torque	20%	
9.	[Deceleration Motor 2]	DEM2	<i>Motor 2 deceleration time</i>	1...60 s	15 s	
10.	[End Of Dec Motor 2]	EDM2	<i>Motor 2 end of controlled deceleration threshold</i>	0...100% of estimated torque when a Stop order is applied	20%	
11.	[Torque Limit Motor 2]	TLM2	<i>Motor 2 torque limit</i>	10...200% of nominal torque or [No]	[No]	
12.	[Dec Gain Motor 2]	TIM2	<i>Motor 2 torque control deceleration gain</i>	10...50 %	40 %	
13.	[Type Of Stop Motor 2]	STM2	<i>Stop mode Motor 2</i>	<ul style="list-style-type: none"> [Freewheel] [Deceleration] [Braking] 	[Freewheel]	
14.	[DC Brake Time 2]	EBM2	<i>DC continuous braking time Motor 2</i>	20...100%	20%	
15.	[Braking Level Motor 2]	BRM2	<i>Dynamic braking level Motor 2</i>	0...100%	50%	
16.	[Freewheel level dec2]	EVM2	<i>Threshold for changing to freewheel stop in voltage control Motor 2</i>	0...100%	20%	
8.	[Jog]	JOG	This function allows to move an engine manually until a given position, at a speed lower than the normal speed.	–	–	
1.	[Jog Assign]	JOG	<i>Jog assignment</i>	<ul style="list-style-type: none"> [Not Assigned] [Act By HMI] [CD●●] 	[Not Assigned]	Motor Jog, page 182
2.	[Slow Speed Assign]	JOSA	<i>Jog slow speed assignment</i>	[Not Assigned] or [CD●●]	[Not Assigned]	
3.	[Torque Level]	JOGF	<i>Torque Level</i>	10...100%	20%	
4.	[Jog Reverse Mode]	JOGR	<i>Jog Reverse Mode</i>	<ul style="list-style-type: none"> [Device Motor Control] [External Contactors] 	[Device Motor Control]	

Menu	Name	Code	Description	Settings	Factory Default Value	Chapter Reference
9.	[Anti-Jam]	AJAM	In waste water applications, clogging substances reduce the efficiency of the system and may decrease the pump service life. Therefore, the Anti-Jam function can help drastically reduce the number of blocking in an impeller, pipe, or valve at downstream location.	–	–	
1.	[Ext Anti-Jam Trigger]	JETC	<i>External Anti-Jam trigger</i>	<ul style="list-style-type: none"> [No] [DI•] [CD••] 	[No]	Anti-Jam, page 184
2.	[Anti-Jam Auto Trig]	JATC	<i>Automatic Anti-Jam trigger</i>	<ul style="list-style-type: none"> [No] [Current Overload] 	[No]	
3.	[Overload Threshold]	LOC	<i>Current overload threshold</i>	50...200% of [Motor Nom Current]	80%	
4.	[Ovld Detection Delay]	TOL	<i>Overload detection delay</i>	0...60 s	10 s	
5.	[Torque Level]	JOGF	<i>Torque Level</i>	10...100%	20%	
6.	[Anti-Jam Fwd Time]	JFDT	<i>Anti-Jam forward time</i>	0...180s	5s	
7.	[Anti-Jam Fwd preset]	JFPS	<i>Anti-Jam forward preset</i>	<ul style="list-style-type: none"> [Starter profile] [Low Force] [Very Low Force] 	[Low Force]	
8.	[Anti-Jam Rv Time]	JRVF	<i>Anti-Jam reverse time</i>	0...180s	5s	
9.	[Anti-Jam Rv preset]	JRPS	<i>Anti-Jam reverse preset</i>	<ul style="list-style-type: none"> [Starter profile] [Low Force] [Very Low Force] 	[Low Force]	
10.	[Anti-Jam Stop Time]	JZST	<i>Anti-Jam stop time between forward and reverse</i>	2...300s	2s	
11.	[Anti-Jam Stop Mode]	JAST	<i>Anti-Jam profile stop mode</i>	<ul style="list-style-type: none"> [Freewheel] [Deceleration] 	[Freewheel]	
12.	[Anti-Jam Cycle Nb]	JNBC	<i>Anti-Jam cycle number</i>	1...10	3	
13.	[Anti-Jam Max Seq]	JAMN	<i>Maximum allowed consecutive Anti-Jam sequences</i>	1...5	2	
14.	[Anti-Jam Interval]	JAMT	<i>Time interval to define two Anti-Jam sequences as consecutive</i>	0...3600s	120s	
10.	[Start pump trajectory]	SBP	This function allows to quickly start following a first torque limit, and smoothly complete the start following a second torque limit.	–	–	Start Pump Trajectory, page 178
1.	[Start Pump Assign]	SPTA	<i>Start pump trajectory activation assignment</i>	<ul style="list-style-type: none"> [Not Assigned] [Time Delay] 	[Not Assigned]	
2.	[Start Pump Torq Limit]	TLIS	<i>Start pump maximum torque limit</i>	100...200% of nominal torque	200%	
3.	[Start Pump Time]	SPTD	<i>Start pump trajectory time</i>	0...30.0s	2.0s	
11.	[Smoke Extraction]	SMOE	This menu is provided to disable certain monitoring functions in such applications so that automatic error detection and automatic error responses of the device are no longer active.	–	–	Smoke Extraction, page 174

Menu	Name	Code	Description	Settings	Factory Default Value	Chapter Reference
1.	[Disable Error Detect]	INH	<i>Disable error detection</i>	<ul style="list-style-type: none"> [Not Assigned] [DI•] [DI• (Low level)] [CD••] 	[Not Assigned]	
	[Forced Run]	INHS	<i>Forced Run</i>	<ul style="list-style-type: none"> [Disabled] [Forced Run FW] [Forced Run RV] 	[Disabled]	
12.	[Command channel]	CCP		–	–	Command Channel, page 197
1.	[Control Mode]	CHCF	<i>Control mode configuration</i>	<ul style="list-style-type: none"> [Standard Profile] [I/O profile] 	[Standard Profile]	
	[Command Switching]	CCS	<i>Command switching</i>	<ul style="list-style-type: none"> [Cmd channel 1]. [Cmd channel 2]. [DI•] [Cy••] 	[Cmd Channel 1]	
3.	[Cmd channel 1]	CD1	<i>Command channel 1 assign</i>	<ul style="list-style-type: none"> [Terminal] [HMI] 	[Terminals]	
4.	[Cmd channel 2]	CD2	<i>Command channel 2 assign</i>	<ul style="list-style-type: none"> [Embd Mdb] [CANopen] [Com. Module] [Embd Eth] 	[Embd Mdb]	
5.	[Copy Ch1-Ch2]	COP	<i>Copy Ch.1-Ch.2</i>	<ul style="list-style-type: none"> [No] [Command] 	[No]	
6.	[2/3-Wire Control]	TCC	<i>2/3-wire control</i>	<ul style="list-style-type: none"> [2-Wire Control] [3-Wire Control] [Hardwired ctrl mode] 	[2-Wire Control]	
7.	[2-wire type]	TCT	<i>Type of 2-wire control</i>	<ul style="list-style-type: none"> [Level] [Transition] 	[Transition]	
8.	[Reverse Assign]	RRS	<i>Reverse assignment</i>	<ul style="list-style-type: none"> [Not Assigned] [DI•] [CD••] 	[Not Assigned]	
9.	[Forced Local Assign]	FLO	<i>Forced local assignment</i>	<ul style="list-style-type: none"> [No] [DI3] [DI4] 	[Not Assigned]	
10.	[Forced Local Chan]	FLOC	<i>Forced Local channel assignment</i>	<ul style="list-style-type: none"> [Terminal] [HMI] 	[Terminals]	
11.	[Time-out forc. local]	FLOT	<i>Time-out forc. local</i>	0.1...30 s	10 s	
13.	[Error/Warn handling]	CSWM		–	–	Error and Warning Handling, page 279
1.	[Ext Error assign]	ETF	<i>External error assignment</i>	<ul style="list-style-type: none"> [Not Assigned] [DI•] [CD••] 	[Not Assigned]	
	[Ext Error Resp]	EPL	<i>Device response to external error</i>	<ul style="list-style-type: none"> [Ignore] [Freewheel Stop] [Configured Stop] [Deceleration] [Braking] 	[Freewheel Stop]	
4.	[Auto Fault Reset]	ATR	<i>Automatic fault reset</i>	<ul style="list-style-type: none"> [No] [Yes] 	[No]	
5.	[Fault Reset Time]	TAR	<i>Fault Reset time</i>	<ul style="list-style-type: none"> [5 minutes] [10 minutes] [30 minutes] 	[5 minutes]	

Menu	Name	Code	Description	Settings	Factory Default Value	Chapter Reference
				<ul style="list-style-type: none"> [1 hour] [2 hours] [3 hours] [Unlimited] 		
6.	[Disable Error Detect]	INH	<i>Disable error detection</i>	<ul style="list-style-type: none"> [Not Assigned] [DI•] [DI• (Low level)] [CD••] 	[Not Assigned]	
7.	[Forced Run]	INHS	<i>Forced Run</i>	<ul style="list-style-type: none"> [Disabled] [Forced Run FW] [Forced Run RV] 	[Disabled]	
8.	[Fault Reset Assign]	RSE	<i>Fault reset input assignment</i>	<ul style="list-style-type: none"> [Not Assigned] [DI•] [CD••] 	[Not Assigned]	
9.	[Product restart]	RP	<i>Product restart</i>	–	[Not Assigned]	
10.	[Prod Restart Assign]	RPA	<i>Product restart assignment</i>	<ul style="list-style-type: none"> [Not Assigned] [DI•] 	[Not Assigned]	
11.	[Control Supply Loss]	CLB	<i>Response to control supply loss</i>	<ul style="list-style-type: none"> [Error] [Error w/o Relay] [Warning]. 	[Error]	
12.	[Warn groups config]	AGCF	<p>This sub-menu sets the configuration of the warning groups.</p> <p>When a warning is triggered, the relay or digital output set to the triggered warning group is activated.</p>	–	–	

[Input/Output]

[DI/DQ]

Menu	Name	Code	Description	Settings	Factory Default Value	Chapter Reference				
1.	[Digital Input 1]	LI1	Those parameters provide the possible low and high assignment to the digital input DI1.	–	–	Digital Inputs Assignment, page 202				
	1.	[DI1 Low Assign]	L1L	DI1 low assignment	–		[No]			
	2.	[DI1 High Assign]	L1H	DI1 high assignment	–		[Run] or [Forward]			
2.	[Digital Input 2]	LI2	Those parameters provide the possible low and high assignment to the digital input DI2.	–	–		Digital Inputs Assignment, page 202			
	1.	[DI2 Low Assign]	L2L	DI2 low assignment	–			[No]		
	2.	[DI2 High Assign]	L2H	DI2 high assignment	–			[Forward] or [No]		
3.	[Digital Input 3]	LI3	Those parameters provide the possible low and high assignment to the digital input DI3.	–	–			Digital Inputs Assignment, page 202		
	1.	[DI3 Low Assign]	L3L	DI3 low assignment	–				[No]	
	2.	[DI3 High Assign]	L3H	DI3 high assignment	–				[No]	
4.	[Digital Input 4]	LI4	Those parameters provide the possible low and high assignment to the digital input DI4.	–	–				Digital Inputs Assignment, page 202	
	1.	[DI4 Low Assign]	L4L	DI4 low assignment	–					[No]
	2.	[DI4 High Assign]	L4H	DI4 high assignment	–					[No]
5.	[DQ1 configuration]	DO1	This menus provide the parameters to assign a function to the digital outputs DQ1 and to set its active level.	–	–	DQ1 & DQ2 Configuration, page 204				
	1.	[DQ1 Assignment]	DO1	DQ1 assignment	–					[Motor Overload Warn]
	2.	[DQ1 Delay time]	DO1D	DQ1 delay time	0...60000 ms					0 ms
	3.	[DQ1 Active at]	DO1S	DQ1 active level	[High Level] or [Low Level]		[High Level]			
	4.	[DQ1 Holding time]	DO1H	DQ1 holding time	0...9999 ms		0 ms			
6.	[DQ2 Configuration]	DO2	This menus provide the parameters to assign a function to the digital outputs DQ2 and to set its active level.	–	–		DQ1 & DQ2 Configuration, page 204			
	1.	[DQ2 Assign]	DO2	DQ2 assignment	–			[Device Running]		
	2.	[DQ2 Delay time]	DO2D	DQ2 delay time	0...60000 ms			0 ms		
	3.	[DQ2 Active at]	DO2S	DQ2 active at	[High Level] or [Low Level]			[High Level]		
	4.	[DQ2 Holding time]	DO2H	DQ2 holding time	0...9999 ms			0 ms		

[AI/AQ]

Menu	Name	Code	Description	Settings	Factory Default Value	Chapter Reference
1.	[AQ1 assignment]	A01	AQ1 assignment	–	[Motor Current]	AQ1 Configuration, page 207
2.	[AQ1 Scaling]	A01S	Analog output AQ1 scaling	50...700 %	200 %	
3.	[AQ1 Type]	A01T	AQ1 Type	[Voltage] or [Current]	[Current]	
4.	[AQ1 min output]	A01L	AQ1 min output value	0...20 mA	0 mA	
5.	[AQ1 max output]	A01H	AQ1 max output value	0...20 mA	20 mA	
6.	[AQ1 min Output]	U01L	AQ1 minimum output	0...10 V	0 V	
7.	[AQ1 max Output]	U01H	AQ1 maximum output	0...10 V	10 V	
8.	[Scaling AQ1 Min]	AS1L	Scaling AQ1 min	0...100 %	0 %	
9.	[Scaling AQ1 Max]	AS1H	Scaling AQ1 max	0...100 %	0 %	
10.	[AQ1 Filter]	A01F	AQ1 filter	0...10 s	0 s	
11.	[AI1 assignment]	AI1A	AI1 assignment	[No] or [AI1 Th Monitoring] TH1S	[No]	AI1 Configuration, page 206
12.	[AI1 Type]	AI1T	Configuration of AI1	–	[Not Configured]	
13.	[AI1 filter]	AI1F	AI1 filter	0...10.00 s	0.00 s	

[Relay]

Menu	Name	Code	Description	Settings	Factory Default Value	Chapter Reference
1.	[R1 Assignment]	R1	R1 assignment	<ul style="list-style-type: none"> [Not Assigned] [Operating State Fault] [Mains Contactor] 	[Operating State Fault] FLT	R1 Configuration, page 209
2.	[R2 Assignment]	R2	R2 assignment	–	[Not Assigned] NO	R2-R3 Configuration, page 210
3.	[R2 Delay time]	R2D	R2 delay time	0...60000 ms	0 ms	
4.	[R2 Active at]	R2S	R2 active level	[High Level] POS or [Low Level] NEG	[High Level] POS	
5.	[R2 Holding time]	R2H	R2 holding time	0...9999 ms	0 ms	
6.	[R3 Assignment]	R3	R3 assignment	–	[Not Assigned] NO	
7.	[R3 Delay time]	R3D	R3 delay time	0...60000 ms	0 ms	
8.	[R3 Active at]	R3S	R3 active level	[High Level] POS or [Low Level] NEG	[High Level] POS	
9.	[R3 Holding time]	R3H	R3 holding time	0...9999 ms	0 ms	

[Communication]

Menu	Name	Code	Description	Settings	Factory Default Value	Chapter Reference
1.	[Modbus Fieldbus]	MD1	This menu is used to set the embedded modbus communication.	–	–	Embedded Modbus, page 241
1.	[Modbus Address]	ADD	Device modbus address	0...247	0	
2.	[Modbus Baud Rate]	TBR	Modbus baud rate	<ul style="list-style-type: none"> • [4800 bps] • [9600 bps] • [19200 bps] • [38.4 Kbps] 	[19200 bps]	
3.	[Term word order]	TWO	Terminal Modbus: Word order	<ul style="list-style-type: none"> • [OFF] • [ON] 	[ON]	
4.	[Modbus Format]	TFO	Modbus format	<ul style="list-style-type: none"> • [8-O-1] • [8-E-1] • [8-N-1] • [8-N-2] 	[8-E-1]	
5.	[ModbusTimeout]	TTO	Modbus timeout	0.1...30 s	5 s	
6.	[Modbus Error Resp]	SLL	Response to Modbus interruption	<ul style="list-style-type: none"> • [Ignore] • [Freewheel Stop] • [Configured Stop] • [Deceleration] • [Braking] 	[Freewheel Stop]	
7.	[Com. scanner input]	ICS	–	–	–	
8.	[Com. scanner output]	OCS	–	–	–	
9.	[Product restart]	RP	Product restart	<ul style="list-style-type: none"> • [Not Assigned] • [Yes] 	[Not Assigned]	
2.	[Embd Eth Config]	ETE	This menu is used to set the embedded ethernet communication.	–	–	Ethernet Embedded Configuration, page 245
1.	[Device Name]	PAN	This parameter is used to set the device name.	–	–	
2.	[IP Mode Ether. Embd]	IM00	IP mode Ethernet Embd	<ul style="list-style-type: none"> • [Fixed] • [BOOTP] • [DHCP] 	[DHCP]	
3.	[IP address]	IC01, IC02, IC03, IC04	This parameter is used to set the IP address and can be edited only when the IP mode is set to fixed address.	–	0.0.0.0	
4.	[Mask]	IM01, IM02, IM03, IM04	This parameter is used to set the IP subnet mask and can be edited only when IP mode is set to fixed address.	–	0.0.0.0	
5.	[Gateway]	IG01, IG02, IG03, IG04	This parameter is used to set the default gateway address and can be edited only IP mode is set to fixed address.	–	0.0.0.0	
6.	[Eth embd : Time-out]	TTOB	Ethernet embedded : time-out	0.1...30.0 s	10.0 s	
7.	[Eth Error Response]	ETHL	Ethernet error response	<ul style="list-style-type: none"> • [Ignore] • [Freewheel Stop] • [Configured Stop] • [Deceleration] 	[Freewheel Stop]	

Menu	Name	Code	Description	Settings	Factory Default Value	Chapter Reference
				• [Braking]		
	8. [Modbus Address]	ADD	Device modbus address	0...247	0	
	9. [Product restart]	RP	Product restart	• [Not Assigned] • [Yes]	[Not Assigned]	
3.	[CANopen]	CNO	This menu is used to set the CANopen communication.	–	–	
	1. [CANopen Address]	ADCO	Device CANopen address	[OFF]..127	[OFF]	
	2. [CANopen Baudrate]	BDCO	CANopen baudrate	• [50 kbps] • [125 kbps] • [250 kbps] • [500 kbps] • [1 Mbps]	[250 kbps]	CANopen fieldbus, page 252
	3. [CANopen Error Resp]	COL	Response to CANopen error	• [Ignore] • [Freewheel Stop] • [Configured Stop] • [Deceleration] • [Braking]	[Freewheel Stop]	
	4. [Product restart]	RP	Product restart	• [Not Assigned] • [Yes]	[Not Assigned]	
4.	[Profibus]	PBC	This menu is used to set the PROFIBUS communication.	–	–	
	1. [Address]	ADRC	Device address	2...126	126	
	2. [Fdbus Interrupt Resp]	CLL	Response to Fieldbus module communication interruption	• [Ignore] • [Freewheel Stop] • [Configured Stop] • [Deceleration] • [Braking]	[Freewheel Stop]	PROFIBUS fieldbus, page 254
	3. [Product restart]	RP	Product restart	• [Not Assigned] • [Yes]	[Not Assigned]	
5.	[Profinet]	PNC	This menu is used to set the PROFINET communication.	–	–	
	1. [IP mode]	IPM	IP mode	• [Fixed] • [DHCP] • [DCP]	[DCP]	
	2. [IP Module]	IPC1, IPC2, IPC3, IPC4	Configured Profinet IP Address	–	0.0.0.0	PROFINET module Basic Settings, page 248
	3. [IP Mask]	IPM1, IPM2, IPM3, IPM4	Configured Profinet IP mask	–	0.0.0.0	
	4. [IP Gate]	IPG1, IPG2, IPG3, IPG4	Configured Profinet IP Gate	–	0.0.0.0	
	5. [Actual IP]	IPA1, IPA2, IPA3, IPA4	Actual IP Address	–	0.0.0.0	
	6. [Actual mask]	IPS1, IPS2, IPS3, IPS4	Actual IP Mask	–	0.0.0.0	
	7. [Actual gate.]	IPT1, IPT2,	Actual IP Gate	–	0.0.0.0	

Menu	Name	Code	Description	Settings	Factory Default Value	Chapter Reference
		IPT3, IPT4				
8.	[PPO profile used]	PRFL	PPO profile used	–	–	
9.	[MAC @]	MAC	–	–	–	
1-0.	[Fdbus Interrupt Resp]	CLL	Response to Fieldbus module communication interruption	–	[Freewheel Stop]	
6.	[Modbus network diag]	MND	This menu is used to diagnostic the embedded modbus communication.	–	–	
1.	[COM LED]	MDB1	View of the Modbus communication LED.	–	–	Modbus Network Diagnostic, page 244
2.	[Mdb Frame Nb]	M1CT	Mdb frame number	0...65535	–	
3.	[Mdb CRC errors]	M1EC	Mdb CRC errors	0...65535	–	
4.	[Mdb com stat]	COM1	Modbus com. status	<ul style="list-style-type: none"> • [R0T0] • [R0T1] • [R1T0] • [R1T1] 	–	
7.	[Ethernet Emb Diag]	MPE	This menu is used to diagnostic the embedded ethernet communication.	–	–	
1.	[MAC @]	MAE	This parameter displays the MAC address of the device in the format [MM-MM-MM-XX-XX-XX].	–	–	Ethernet Embedded Diagnostic, page 247
2.	[ETH emb Rx frames]	ERXE	Ethernet embedded Rx frames	–	–	
3.	[ETH emb Tx frames]	ETXE	Ethernet embedded Tx frames	–	–	
4.	[ETH emb error frames]	EERE	Ethernet embedded error frames	–	–	
5.	[Ethernet Rate Data]	ARDE	Ethernet rate data	<ul style="list-style-type: none"> • [Auto] • [10M. full] • [10M. half] • [100M. full] • [100M. half] 	[Auto]	
6.	[Product restart]	RP	Product restart	<ul style="list-style-type: none"> • [Not Assigned] • [Yes] 	[Not Assigned]	
8.	[Profibus diag]	PRB	This menu is used to diagnostic the PROFIBUS communication.	–	–	
1.	[Data rate used]	BDRU	Data rate used	<ul style="list-style-type: none"> • [Automatic] • [9600 bps] • [10 Kbps] • [19200 bps] • [45.45 Kbps] • [93.75 Kbps] • [187.5 Kbps] • [500 Kbps] • [1.5 Mbps] • [3 Mbps] • [6 Mbps] • [12 Mbps] 	[Automatic]	See communication manual.
2.	[PPO profile used]	PRFL	PPO profile used	<ul style="list-style-type: none"> • [Not Configured] • [100] 	[Not Configured]	

Menu	Name	Code	Description	Settings	Factory Default Value	Chapter Reference
				<ul style="list-style-type: none"> [101] [102] [106] [107] 		
3.	[DP Master Active]	DPMA	DP Master active	<ul style="list-style-type: none"> [Master 1] [Master 2] 	[Master 1]	
4.	[Fieldbus Error]	EPF2	External error detected by Fieldbus	–	–	
5.	[Fdbus Com Interrupt]	CNF	Fieldbus communication interruption	–	–	
6.	[InternCom Error1]	ILF1	Internal communication interruption 1	–	–	
9.	[Profinet diag]	PRN	This menu is used to diagnostic the PROFINET communication.	–	–	
1.	[MAC @]	MAC	This parameter displays the MAC address of the device in the format [MM-MM-MM-XX-XX-XX].	–	[Automatic]	
2.	[PPO profile used]	PRFL	PPO profile used	<ul style="list-style-type: none"> [Not Configured] [100] [101] [102] [106] [107] 	[Not Configured]	See communication manual.
3.	[Fdbus Com Interrupt]	CNF	Fieldbus communication interruption	–	–	
4.	[InternCom Error1]	ILF1	Internal communication interruption 1	–	–	
10.	[CANopen map]	CNM	This menu is used to diagnostic the CANopen communication.	–	–	
1.	[RUN LED]	CON	RUN LED	–	–	See communication manual.
2.	[ERR LED]	CANE	ERR LED	–	–	
3.	[PDO1 image]	P01	–	–	–	
4.	[PDO2 image]	P02	–	–	–	
5.	[PDO3 image]	P03	–	–	–	
6.	[Canopen NMT state]	NMTS	Canopen NMT state	<ul style="list-style-type: none"> [Boot] [Operation] [Stopped] [Pre-op] 	–	
7.	[Number of TX PDO]	NBTP	Number of TX PDO	0..65535	–	
8.	[Number of RX PDO]	NBRP	Number of RX PDO	0..65535	–	
9.	[CANopen Error]	ERCO	CANopen error	–	–	
1-0.	[RX Error Counter]	REC1	RX error counter	0..65535	–	
1-1.	[TX Error Counter]	TEC1	TX error counter	0..65535	–	

[Display]

[Motor parameters]

Menu	Name	Code	Description	Display	Factory Default Value	Chapter Reference
1.	[Currents]	MMOI	This menu provides the parameters to monitor current measurements.	–	–	Monitor current measurements, page 257
	1. [Motor Current]	LCR	Motor current	–	–	
	2. [Mains Frequency]	FAC	Mains frequency	0...100.0Hz	–	
	3. [Current RMS T1]	LCR1	Current RMS Phase T1	–	–	
	4. [Current RMS T2]	LCR2	Current RMS Phase T2	–	–	
	5. [Current RMS T3]	LCR3	Current RMS Phase T3	–	–	
2.	[Voltages]	VMGV	This menu provides the parameters to monitor voltage measurements.	–	–	Monitor voltage measurements, page 258
	1. [Mains Voltage]	ULNM	Mains Voltage (RMS)	0...1000V	–	
	2. [Mains Frequency]	FAC	Mains frequency	0...100.0Hz	–	
	3. [Mains voltage phase 1-2]	UL1	Mains voltage phase 1-2	0...1000V	–	
	4. [Mains voltage phase 2-3]	UL2	Mains voltage phase 2-3	0...1000V	–	
	5. [Mains voltage phase 3-1]	UL3	Mains voltage phase 3-1	0...1000V	–	
	6. [Mains Unbalance Ratio]	UMV	Mains unbalance ratio	0...100%	–	
3.	[Powers]	MMOP	This menu provides the parameters to monitor power measurements.	–	–	Monitor power measurements, page 259
	1. [Power Factor]	COS	Power factor	0.00...1.00	–	
	2. [Device Efficiency]	DEFF	Device efficiency	0...100 %	–	
	3. [Acv Elc Out Pwr in %]	EPR	Active Electrical output power in %	0...500 %	–	
	4. [Acv Elc Out Pwr in kW]	EPRW	Active Electrical output power in kW	–	–	
	5. [Peak Elec Out Power]	MOEP	Peak electrical output power	–	–	
4.	[Others]	MMOM	This menu provides the parameters to monitor others measurements.	–	–	Monitor others measurements, page 260
	1. [Motor Torque]	LTR	Torque reference	0...255 % of the nominal torque	–	
	2. [Est. Motor Torq Val.]	LTRN	Estimated motor torque value	-32767...32767 N.m	–	
	3. [Nom Motor torque]	TQN	Computed nominal motor torque	NA...30000 N.m	–	
	4. [Mot Mech Power in %]	OPR	Motor power in %	NA...100%	–	
	5. [Power Estim Value]	OPRW	Motor mechanical power estimation	Setting: -32768...32767	–	

[Motor parameters] (Continued)

Menu	Name	Code	Description	Display	Factory Default Value	Chapter Reference
6.	[Time Before Starting]	MRTR	<i>Maximum remaining time before restart</i>	0.4294967295 s	–	
7.	[Phase Direction]	PHE	<i>Detected phase direction</i>	–	–	
8.	[Real Start Time]	RSTT	<i>Real Start Time</i>	0...1000s	–	
9.	[Braking Speed Thld]	BRKS	<i>Braking speed threshold</i>	NA...100%	–	
1-0.	[Braking Duration]	BRKT	<i>Braking duration(from brake order to DC injection end)</i>	0...1000s	–	

[Thermal Monitoring]

Menu	Name	Code	Description	Display	Factory Default Value	Chapter Reference
1.	[Motor Therm State]	THR	<i>Motor thermal state</i>	0...300 %	–	Monitor thermal measurements, page 262
2.	[Time Before Starting]	THTR	<i>Motor thermal remaining time before restart</i>	NA...3600s	–	
3.	[AI1 Th Value]	TH1V	<i>AI1 thermal value</i>	-32768...32767	–	
4.	[Device Thermal State]	THS	<i>Device thermal state</i>	0...200 %	–	

[Counter Management]

Menu	Name	Code	Description	Display	Factory Default Value	Chapter Reference
1.	[Motor Run Time]	RTHH	<i>Motor run time</i>	0...119304.6 h	–	Counter Management, page 263
2.	[Power-on time]	PTHH	<i>Power-on time</i>	0...119304.6 h	–	
3.	[Nb Of Starts]	NSM	<i>Number of motor starts</i>	0...4294967295	–	
4.	[Bypass Life Cycle]	BPCL	<i>Bypass contactor life cycle rate</i>	0...100%	–	
5.	[No]	RPR	<i>Counter reset</i>	<ul style="list-style-type: none"> • [No] • [Reset Cons] • [Reset Run Time] • [Reset Pw On Time] • [Reset Fan Count] • [Reset Start Count] • [Voltage Sag Counter] • [Fan 1 run time] • [Fan 2 run time] • [Fan 3 run time] • [Reset All] 	[No]	

[I/O Map]

Menu	Name	Code	Description	Display	Factory Default Value	Chapter Reference
1.	[Digital Input Map]	LIA	This menu is used to display the state of digital inputs and of STO.	–	–	Input & Output Map, page 265
2.	[Analog inputs image]	AIA	This menu is used to display the state of analog inputs.	–	–	
3.	[Digital Output Map]	LOA	This menu is used to display the state of digital outputs and relays.	–	–	

[I/O Map] (Continued)

Menu	Name	Code	Description	Display	Factory Default Value	Chapter Reference
4.	[Analog outputs image]	AOA	This menu is used to display the state of analog outputs.	–	–	

[Energy parameters]

Menu	Name	Code	Description	Display	Factory Default Value	Chapter Reference
1.	[Acv Elc Out Pwr in kW]	EPRW	Active Electrical output power in kW	Range link to NPR power scaling .	–	
2.	[Peak Elec Out Power]	MOEP	Peak electrical output power	Range link to NPR power scaling .	–	
3.	[Elc Energy Cons]	OC4	Electrical energy consumed by the motor in TWh.	0...999 TWh	–	
4.	[Elc Energy Cons]	OC3	Electrical energy consumed by the motor in GWh.	0...999 GWh	–	
5.	[Elc Energy Cons]	OC2	Electrical energy consumed by the motor in MWh.	0...999 MWh	–	
6.	[Elc Energy Cons]	OC1	Electrical energy consumed by the motor in kWh.	0...999 kWh	–	
7.	[Elc Energy Cons]	OC0	Electrical energy consumed by the motor in Wh.	0...999 Wh	–	
8.	[Elc Egy Today]	OCT	Electrical energy consumed today by the motor in kWh.	0...4,294,967,295 kWh	–	
9.	[Elc Egy Yesterday]	OCY	Electrical energy consumed yesterday by the motor in kWh.	0...4,294,967,295 kWh	–	
11.	[Reactive Energy]	IRE4	Reactive energy produced by the motor in TVArh.	0...999 TVArh	–	
12.	[Reactive Energy]	IRE3	Reactive energy produced by the motor in GVArh.	0...999 GVArh	–	
13.	[Reactive Energy]	IRE2	Reactive energy produced by the motor in MVArh.	0...999 MVArh	–	
14.	[Reactive Energy]	IRE1	Reactive energy produced by the motor in kVArh.	0...999 kVArh	–	
15.	[Reactive Energy]	IRE0	Reactive energy produced by the motor in VArh.	0...999 VArh	–	
16.	[No]	RPR	Counter reset	<ul style="list-style-type: none"> • [No] • [Reset Cons] • [Reset Run Time] • [Reset Pw On Time] • [Reset Fan Count] • [Reset Start Count] • [Voltage Sag Counter] • [Fan 1 run time] • [Fan 2 run time] • [Fan 3 run time] • [Reset All] 	[No]	

[Diagnostics]

[Diag. data]

This menu provides the parameters to display the last warning and last detected error in addition to device data.

Menu	Name	Code	Description	Display	Factory Default Value	Chapter Reference
1.	[Last Error]	LFT	Last error occurred	–	–	Diagnostic Data , page 271
2.	[Last Warning]	LALR	Last warning	–	–	
3.	[Internal Error 6]	INF6	Internal error 6 (Option)	–	–	
4.	[Cust Supply Diag]	CPSF	Customer supply error diagnostic	–	–	
5.	[Service Message]	SER		–	–	
6.	[LED Diagnostics]	HLT		–	–	
7.	[Customer Supply 24V]	SUP1	Customer supply 24V	0.0...6553.5 V	–	
8.	[Control Supply 24V]	SUP2	Control supply 24V	0.0...6553.5 V	–	
9.	[Control Supply 13V]	SUP3	Control supply 13V	0.0...6553.5 V	–	
10.	[Power Supply 12V]	SUP6	Power Supply 12V	0.0...6553.5 V	–	
11.	[Clear Error History]	RFLT	Clear error history	[No] or [Yes]	[No]	
12.	[Phase Loss Status]	OPFS	Motor phases loss status	–	–	
13.	[Mains Loss Status]	PHFS	Mains input phases loss status	–	–	
14.	[Mains Loss Location]	GRDS	Location of the loss of the Mains Grid	–	–	
15.	[Bypass Life Cycle]	BPCL	Bypass contactor life cycle rate	0...100%	–	
16.	[Bypass Diagnostics]	BPED	Bypass diagnostics	–	–	
17.	[Product restart]	RP	Product restart	[No] or [Yes]	[No]	

[Error history]

This menu shows the 15 last detected errors.

Menu	Name	Code	Description	Display	Factory Default Value	Chapter Reference
1.	[Device State]	HS1	HMI status	–	–	Error History, page 274
2.	[Last Error 1 Status]	EP1	Status of last error 1	–	–	
3.	[ETI state word]	IP1	ETI state word	–	–	
4.	[Cmd word]	CMP1	Cmd word	–	–	
5.	[Motor current]	LCP1	Motor current	–	–	
6.	[Run Elapsed time]	RTP1	Run Elapsed time	–	–	
7.	[Motor therm state]	THP1	Motor thermal state	–	–	
8.	[Command Channel]	DCC1	Command channel	–	–	
9.	[Motor Torque]	OTP1	Motor torque	0...255 % of the nominal torque	–	
10.	[Device Thermal State]	TSP1	Device thermal state	0...200%	–	
11.	[Warn Group Status]	AGP1	Warning group status	–	–	
12.	[Mains Max Inst. Volt.]	ULM1	Mains maximum instant voltage	–	–	

[Warnings]

This menu shows the actual warnings, warnings group definition and warning history.

Menu	Name	Code	Description	Display	Factory Default Value	Chapter Reference
1.	[Actual Warnings]	ALRD	This menu shows the actual warnings.	-	-	Warning Messages, page 289
2.	[Warn grp 1 definition] to [Warn grp 5 definition].	A1C to A5C	This menu shows the warnings group definition.	-	-	
3.	[Warning History]	ALH	This menu shows the warning history.	-	-	

[Fan diagnostic]

These menus show the fans diagnostic.

Menu	Name	Code	Description	Display	Factory Default Value	Chapter Reference
1.	[Fan status]	FAMS	This menu shows the fans status.	-	-	Fan status, page 277
1.	[Fan status register]	FPAD	<i>Fan operating status register</i>	<ul style="list-style-type: none"> [No Warning] [Event On Fan 1] [Event On Fan 2] [Event On Fans 1&2] [Event On Fan 3] [Event On Fans 1&3] [Event On Fans 2&3] [Event On All Fans] [Undefined Fan Event] [Result Not Available] 	-	
2.	[Fan 1 status], [Fan 2 status], [Fan 3 status]	FFA1, FFA2, FFA3	<i>Fan 1 operating status, Fan 2 operating status, Fan 3 operating status</i>	<ul style="list-style-type: none"> [OK] [Warning] [Error] 	-	
3.	[Fan 1 run time], [Fan 2 run time], [Fan 3 run time]	FPT1, FPT2, FPT3	<i>Fan 1 operating time, Fan 2 operating time, Fan 3 operating time</i>	0...500000 h	-	
4.	[Fan 1 speed], [Fan 2 speed], [Fan 3 speed]	FSP1, FSP2, FSP3	<i>Fan 1 operating speed, Fan 2 operating speed, Fan 3 operating speed</i>	0...65535 rpm	-	
5.	[Fan Run Time Thld]	FPTA	<i>Fan operating time threshold</i>	0...65535 h	-	
2.	[Fan Diagnostics Test]	FNTD	A test of fans can be launched to check operation of the fans functionality with [Fan Diagnostics test].	-	-	Fan diagnostics test, page 278
1.	[Fan Diagnostics test]	FNT				
3.	[Counter reset]	FAMR	This menu is used to reset fan counters.	-	-	Fan Counter Reset, page 278
1.	[Reset Fan 1 Run Time]	FTR1	<i>Reset fan 1 operating time</i>	-	-	
2.	[Reset Fan 2 Run Time]	FTR2	<i>Reset fan 2 operating time</i>	-	-	
3.	[Reset Fan 3 Run Time]	FTR3	<i>Reset fan 3 operating time</i>	-	-	

[Device Management]

Menu	Name	Code	Description	Display	Factory Default Value	Chapter Reference
1.	[Device Name]	PAN	Used to set the device name.	–	–	Ethernet Embedded Configuration, page 245
2.	[Identification]	OID	Displays the identification numbers of the soft starter.	–	–	Soft starter Firmware information, page 219
3.	[Save/Load]	SLF	Saving & restoring acts only on the device configuration file.	–	–	–
1.	[Copy From Device]	SAF	Allows to store the actual soft starter configuration into the Graphic Display Terminal.	–	–	Save & Restore a device configuration, page 214
2.	[Copy To The Device]	OPF	Allows to select a device configuration previously stored in the Graphic Display Terminal and apply it to the soft starter.	–	–	
3.	[Save backup image]	SBK	Used to save the actual product configuration and cybersecurity policy into the Display Terminal.	–	–	Save & Restore a device image, page 215
4.	[Load backup image]	OBK	Used to select a product configuration and cybersecurity policy configuration previously stored in the Graphic Display Terminal and apply it to the soft starter.	–	–	
5.	[Clear device]	CLR	–	–	–	Clear Device / Secure Decommissioning, page 239
4.	[Factory settings]	FCS	Proceeding a factory settings aims to restore the original settings of the soft starter by erasing all modified parameters.	–	–	Proceed with a Manufacturer Factory settings, page 216 and Proceed with a User-Defined Factory settings, page 217
1.	[Config. Source]	FCSI	Source configuration	–	–	
2.	[Parameter group list]	FRY	–	–	–	
3.	[Go to Factory Settings]	GFS	–	–	–	
4.	[Save Configuration]	SCSI	Save configuration	–	–	
5.	[Cybersecurity]	CYBS	This chapter defines the elements that help to configure a system that is less susceptible to cyber-attacks.	–	–	Cybersecurity Generalities, page 56 and Cybersecurity Operating
1.	[Load security policy]	OSE	Used to select a cybersecurity policy configuration previously stored in the Graphic Display	–	–	Save & Restore a Security Policy, page 234

Menu	Name	Code	Description	Display	Factory Default Value	Chapter Reference
			Terminal and apply it to the soft starter.			
	2. [Save security policy]	SSE	Used to save the actual cybersecurity policy into the Graphic Display Terminal.	–	–	
	3. [Reset Password]	SRPW	Reset password	–	–	
6.	[Date & Time]	DTO	–	–		Set date and time, page 99
	1. [Set Date/Time]	DTO	–	–		
	2. [Time Format]	TIMF	–	–		
	3. [Date Format]	DATE	–	–		
	4. [Battery Level]	EBAL	–	–		Scheduled Servicing, page 316
7.	[Emb Eth FDR]	FDR	The FDR (Fast Device Replacement) service is used to simplify the maintenance of soft starters connected to an Ethernet network. The FDR can be set using these parameters.	–	–	ATS490 EtherNet Manual
	1. [Enable FDR]	FDV0	Enable FDR function	–	[No]	
	2. [FDR Action]	FDA0	FDR action	<ul style="list-style-type: none"> • [NOT ACTIVE] • [SAVE] • [REST] 	–	
	3. [FDR Operating State]	FDS0	FDR operating state	–	–	
	4. [FDR Error Status]	FDR0	FDR error status	–	–	
8.	[Firmware update]	FWUP	-	-	-	Soft starter firmware update, page 219
	1. [Version Info]	VIF	-	-	-	
	2. [Check For Update]	NFW	-	-	-	
	3. [Available Packages]	APK	-	-	-	

Menu	Name	Code	Description	Display	Factory Default Value	Chapter Reference
9.	[Simulation mode]	SIMU	-	-	-	Perform a simulation with the device, page 334
1.	[Simu Mode Assign]	SIMM	<i>Simulation mode assignment</i>	-	[No]	
2.	[Simu Motor Pairing]	SIMP	<i>Simulated motor paired on product rating</i>	-	-	
3.	[Simu Static Load]	SIMS	<i>Simulated static load</i>	0...200 %	0	
4.	[Simu Linear Load]	SIML	<i>Simulated linear load</i>	0...200 %	0	
5.	[Simu Quadratic Load]	SIMQ	<i>Simulated quadratic load</i>	0...200 %	100 %	
6.	[Simulated Action]	SIMC	<i>Simulated action</i>	-	-	
7.	[Simu Mains Settings]	SMA	-	-	-	
	1.	[Simu Mains Volt]	<i>Mains voltage in simulation mode</i>	170...760 V	400 V	
	2.	[Simu Mains Freq]	<i>Mains frequency in simulation mode</i>	30.0...80.0 Hz	50 Hz	
10.	[Clear device]	CLR	-	-	-	

[My preferences]

Menu	Name	Code	Description	Settings	Factory Default Value	Chapter Reference
1.	[Language]	LNG	-	-	-	Select languages, page 98
2.	[Parameter access]	PAC	-	-	-	
	1.	[Access Level]	<i>Access level</i>	-	[Standard]	Define Parameter Visibility, page 113
3.	[Customization]	CUS	-	-	-	
	1.	[Stop Key Enable]	<i>Stop key enable</i>	-	[Stop Key Priority]	Activate/deactivate Parameter "STOP/RESET" Display terminal button, page 100
	2.	[HMI L/R cmd]	<i>HMI local/remote command</i>	-	[Disabled]	Set <i>HMI local/remote command</i> , page 100
	3.	[My menu config.]	-	-	-	Define Favorite Parameters List, page 117
		1.	[Parameter Selection]	-	-	
		2.	[Display Selection]	-	-	
		3.	[Selected list]	-	-	
		4.	[My menu]	-	-	
4.	[Display screen type]	MSC	-	-	-	
	1.	[Display value type]	<i>HMI displayed value type</i>	-	[Digital]	Customize the default screen parameter visualization, page 102

Menu	Name	Code	Description	Settings	Factory Default Value	Chapter Reference	
	2	[Parameter Selection]	MPC	-	-	Select monitored parameter on Display line , page 103	
	5.	[Param. Bar Select]	PBS	-	-	List of parameters available for Default screen and display line , page 104	
	6.	[Service Message]	SER	-	-		
4.		[LCD settings]	CNL	-	-		
	1.	[Screen Contrast]	CST	-	-	Configure the screen contrast, page 99	
	2.	[Standby]	SBY	-	-	Configure the Display Terminal backlight function, page 99	
	3.	[Display Terminal locked]	KLCK	Display terminal locked	0...10 min	5 min	Customize time to lock Display terminal keys, page 100
	4.	[Red Backlight]	BCKL	Red Backlight	-	[Yes]	Configure the Display Terminal backlight function, page 99
4.		[QR code]	QRC	-	-	Customizable QR codes, page 104	
	1.	[QR code]	QCC	-	-		
	2.	[My Link 1]	MYL1	-	-		
	3.	[My Link 2]	MYL2	-	-		
	4.	[My Link 3]	MYL3	-	-		
	5.	[My Link 4]	MYL4	-	-		
5.		[Boards pairing]	PPI	-	-		

Glossary

D

Display terminal:

The Display Terminal is a local control unit plugged on the soft starter. The Display Terminal can be removed to be mounted on the door of the wall-mounted or floor-standing enclosure, using a dedicated door-mounting kit.

E

Error :

Discrepancy between a detected (computed, measured, or signaled) value or condition and the specified or theoretically correct value or condition.

F

Factory setting:

Machine status in factory settings when the product was shipped.

Fault Reset:

A function used to restore the soft starter to an operational state after a detected error is cleared by removing the cause of the error so that the error is no longer active.

Fault:

Fault is an operating state. If the monitoring functions detect an error, a transition to this operating state is triggered, depending on the error class. A "Fault reset" is required to exit this operating state after the cause of the detected error has been removed.

M

Monitoring function:

Monitoring functions acquire a value continuously or cyclically (for example, by measuring) in order to check whether it is within permissible limits. Monitoring functions are used for error detection.

N

NC contact:

Normally Closed contact

NO contact:

Normally Open contact

Normal Duty and Heavy Duty :

Normal duty and heavy duty are differentiated by the required overload that is defined by the following:

- Service duty: continuous or intermittent
- Service factor
- Overcurrent value
- Overcurrent duration

Each application duty has a corresponding motor protection class:

- Normal Duty → motor thermal protection class 10E
- Heavy Duty → motor thermal protection class 20E

For more examples, refer to *Difference between Normal and Heavy duty*, page 330.

O

OVCII:

Overvoltage Category II, according IEC 61800-5-1

P

Parameter:

Device data and values that can be read and set (to a certain extent) by the user.

PTC:

Positive Temperature Coefficient. PTC thermistor probes integrated in the motor or application to measure its temperature

S

SCPD:

Short-Circuit Protective Device

SCR: Silicon Controlled Rectifiers

STO:

Safe Torque Off: No power that could cause torque or force is supplied to the motor

T

TVS Diode:

Transient Voltage Suppression Diode

W

Warning:

If the term is used outside the context of safety instructions, a warning alerts to a potential error that was detected by a monitoring function. A warning does not cause a transition of the operating state.

Schneider Electric
35 rue Joseph Monier
92500 Rueil Malmaison
France

+ 33 (0) 1 41 29 70 00

www.se.com

As standards, specifications, and design change from time to time, please ask for confirmation of the information given in this publication.

© 2024 – 2026 Schneider Electric. All rights reserved.

PKR52680.03 – 01/2026